



Review

Large-Scale 3D Printing for Construction Application by Means of Robotic Arm and Gantry 3D Printer: A Review

Anastasia Puzatova ¹, Pshtiwan Shakor ^{2,3,4}, Vittoria Laghi ^{5,6,*} and Maria Dmitrieva ¹¹ Immanuel Kant Baltic Federal University, Ulitsa Aleksandra Nevskogo, 14, 236041 Kaliningrad, Russia² Technical College of Engineering, Sulaimani Polytechnic University, Sulaymaniyah 46001, KRG, Iraq³ Civil Engineering Department, College of Engineering, Tishk International University, Sulaymaniyah 46001, KRG, Iraq⁴ Institute of Construction Materials, Sydney, NSW 2748, Australia⁵ Department of Civil, Chemical, Environmental and Materials Engineering (DICAM), University of Bologna, 40136 Bologna, Italy⁶ Department of Civil and Environmental Engineering (CEE), Massachusetts Institute of Technology, Cambridge, MA 02136, USA

* Correspondence: vittoria.laghi2@unibo.it

Abstract: Additive manufacturing technologies are becoming more popular in various industries, including the construction industry. Currently, construction 3D printing is sufficiently well studied from an academic point of view, leading towards the transition from experimental to mass large-scale construction. Most questions arise about the applicability of construction 3D printers for printing entire buildings and structures. This paper provides an overview of the different types of construction 3D printing technologies currently in use, and their fundamental differences, as well as some significant data on the advantages of using these advanced technologies in construction. A description of the requirements for composite printing is also provided, with possible issues that may arise when switching from lab-scale construction printing to mass large-scale printing. All printers using additive manufacturing technologies for construction are divided into three types: robotic arm printers, portal-type printers, and gantry 3D printers. It is noted that gantry printers are more suitable for large-scale printing since some of their configurations have the ability to construct buildings that are practically unlimited in size. In addition, all printers are not capable of printing with concrete containing a coarse aggregate, which is a necessary requirement in terms of the strength and economic feasibility of 3D printing material for large-scale applications.

Keywords: large-scale 3D printing; structural application; concrete 3D printing; metal 3D printing; composite 3D printing



Citation: Puzatova, A.; Shakor, P.; Laghi, V.; Dmitrieva, M. Large-Scale 3D Printing for Construction Application by Means of Robotic Arm and Gantry 3D Printer: A Review. *Buildings* **2022**, *12*, 2023. <https://doi.org/10.3390/buildings12112023>

Academic Editor: Jianguang Fang

Received: 20 September 2022

Accepted: 8 November 2022

Published: 18 November 2022

Publisher's Note: MDPI stays neutral with regard to jurisdictional claims in published maps and institutional affiliations.



Copyright: © 2022 by the authors. Licensee MDPI, Basel, Switzerland. This article is an open access article distributed under the terms and conditions of the Creative Commons Attribution (CC BY) license (<https://creativecommons.org/licenses/by/4.0/>).

1. Introduction

Using 3D printing in the construction industry is gaining attention as a high-potential means of digitalization and automation of the construction process. This new level of technology is often referred to as Construction Industry 4.0. In many industries, additive manufacturing technologies has already gone beyond laboratory research and is used in real-life applications, such as industrial use [1–3] in the pharmaceutical industry [4–6], food industry [7,8] and even in the textile industry and the fashion world [9]. Additive manufacturing technologies are used, for example, in medicine of printing implants [10,11], in the mechanical industry to create parts [12,13] and moulds for casting metal products [14,15].

The growth of automation since the beginning of the 21st century has prevailed in most production domains with the exception of the building and construction sector, in which the use of automatic tools is still challenging and requires further development to implement in real-life applications. The main challenge is due to some particular aspects in the construction sector: (i) building and construction produces extremely large-scale products

requiring customization of conventional automated fabrication technologies; (ii) conventional design approaches are not tailored for automation; (iii) there is a significantly smaller ratio of production quantity to type of final product as compared with other industries; (iv) limitations in the materials that can be employed by an automated system [16]; (v) each instance of automotive manufacturing has a specific manufacturing process [17]. Only in the last few years, the fast development in digital fabrication techniques is leading to applications, as seen, for example, in the structural and civil engineering field, Additive Manufacturing (AM)-based technologies are commonly used in other sectors, such as aerospace, automotive and biomedical engineering [18–20]. Meanwhile, a large number of tests was carried out on the use of concrete 3D printing technologies in construction to create non-formwork structures [21,22]. Many tests on building materials for 3D printed structures were also carried out. The requirements for freshly mixed and hardened compositions for structures [23–26] were conducted, including eco-friendly materials [27].

Despite the fact that 3D printing in construction has already been studied sufficiently in the laboratory, there are still no regulatory documents in this area of application for additive manufacturing technologies. Currently, all known research has been carried out using existing test methods to adapt concrete for 3D printing [28]. Therefore, while the amount of research conducted on large-scale printing is not great at this stage [29], the introduction of regulatory documents would be the first step towards the transition from experimental construction to its use in the mass construction of buildings and structures. Moving from lab to large-scale printing comes with inevitable challenges, as printing large scale can dramatically change even a well-studied technology [30].

The most widely used 3D printing technology for construction is the layer-by-layer extrusion technique [22,23,31–35]. This technology is suitable for large-scale mass construction [36] and can be functional for concrete and metal; these two are the most widely adopted in the construction materials market. Additionally, these two materials can be combined to provide reinforced concrete 3D printed structures [37–42] or alternatively, as composite concrete 3DP structures.

This paper provides an overview of the state of large-scale construction 3D printing, by focusing on concrete 3D printing and metal 3D printing extrusion processes, or combined methods as a composite 3DP process. The review provides an overview of the main types of printers and describes the materials used, and shows the differences between a laboratory perspective and large-scale 3DP in the construction industry.

2. Overview of 3DP in Construction

2.1. Methodology

A systematic methodology for the literature review is adopted in this review paper which includes three main stages: types of printer, materials and the printing process. The compilation of these stages involves identifying and shortlisting the best research papers in this field. Figure 1 showed the detail of the methodology in this review paper. The search involved using keywords in the Scopus database which publishes papers in this field.

Figure 1 displays the main categories of this overview paper; under types of printer, both non-mobile and mobile robotic arm 3DP were discussed in one section. Materials and 3DP process are the other two sections.

The methodology for writing this review article was to search, systematize and analyze relevant information on the topic of large-scale 3DP. The scientific research of leading scientists on construction additive technologies, as well as technological developments of universities and private manufacturing companies, were taken as the basis. The scientific studies analyzed in this review are published in high-ranking scientific journals and have a large percentage of citations, which confirms the relevance of the chosen review topic and the reliability of the information sources. Particular attention was paid to the review of projects in the field of concrete 3D printing and steel 3D printing (and in particular Wire-and-Arc Additive Manufacturing, which is the most promising for large-scale metal 3D printing

applications), implemented around the world. Both classical prototypes of the first building 3D printers and the latest developments in this area, the number of which is increasing every month, are presented. The main purpose of this review was to systematize current developments, that is, to present the most popular methods of large-scale construction 3DP, to determine their advantages and disadvantages, to state the problems that must be solved for the successful implementation of large-scale construction 3D printing, and to describe the materials used and their characteristics. The review includes only successfully realized projects that give an idea of the rapid development of concrete 3D printing technology and WAAM.

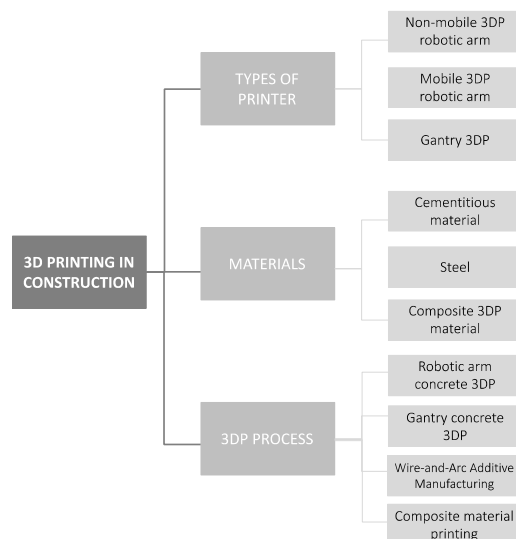

Figure 1. Concrete 3DP methodology categorization.

The method of studying a large number of sources of information and comparing various technologies used in this review article allowed us to combine data from numerous studies and come to a single conclusion that is statistically stronger than that of individual studies.

2.2. Significance of 3DP in Construction

The development of additive manufacturing technologies in construction is associated with many advantages for the construction industry. Firstly, there is the progress of digitalization and the general automation of the production process, which also affects construction. There is a reduction in working labour required due to the introduction of automation, and programming equipment to perform certain types of work. Thus, for the construction of a small building using 3D printing technologies, a group of workers is not necessary; a few qualified specialists are enough to run a printed project, develop the project itself and select the types of materials that are crucial. Secondly, there is a reduction in construction time. There is a well-known example of the Apis Cor company who created a small building in only 24 h [40]. Another example is building with a CONPrint3D printer. The 3DP method was compared with the traditional construction method, and it is 25% cheaper to build one floor of a building with a printer. The printing of one floor with an area of about 130 m² can be made in one day. The current printing speed is 150 mm/s with a layer height of 50 mm. The printing process requires only two people: a specially trained machine operator and a professional skilled worker [36]. Thus, by using construction 3D printing, it is possible to build houses in a very short time, particularly where it is urgently needed. For example, to build hospitals after devastating earthquakes, fires, and other natural disasters such as spreading viruses, or for the urgent resettlement of a large number of people such as refugees.

According to many researchers, 3D printing technology in construction is accompanied by a reduction in material consumption and less generated construction waste [29,43,44].

Accordingly, it would be logical to assume that this also reduces the cost of construction. However, this issue still remains controversial, since the ingredients of construction 3D printing contain an increased amount of cement, which leads to an increase in the cost of the material. In addition, a large amount of cement has a negative impact on the environment, since the production of cement is harmful due to the release of huge amounts of carbon dioxide, and the high amount of energy required to produce it. The solution for this issue could be use of industrial waste to reduce the amount of cement, or using alternative materials such as geopolymers or earth-based materials such as calcined clay. Large-scale construction usually uses large amounts of coarse aggregate in concrete. The ingredients of concrete contain less cement, which is more environmentally friendly and less expensive [45,46], in comparison with concretes and mortars for additive manufacturing technologies in construction. Despite the fact that a lot of research has been carried out in the field of construction 3D printing, the use of such a technique in large-scale construction is still under development, due to reasons including the high cost of the technology itself [47,48]. In addition, it is necessary to study this technology from the point of view to its impact on the environment, that is, to assess its life cycle. The Life Cycle Assessment method is a method to assess the impact of producing products and their processes on the environment, this method has been used in the construction sector over the past 20 years [49]. This method includes two approaches—firstly, a comprehensive assessment of the environmental impact of a building throughout its entire life cycle, including all associated processes and materials. The second approach evaluates and compares only the environmental impact of construction materials and/or construction methods. When it comes to 3D printing, researchers mainly focus on the environmental impact of printing small objects. For example, it is estimated that 3D printing with geopolymers has less impact on the environment when building elements with a complex structure, while printing with ordinary concrete is more environmentally friendly when creating structures with ordinary walls. Recently, scientists have been interested in materials for 3D printing which are earth-based such as cob, which is obviously more environmentally friendly than concrete, since it consists mainly of natural materials (water, earth, straw, additionally clay and sand) [49].

The most attractive feature of building with a 3D printer is the ability to create complex geometric shapes, as opposed to the process of conventional concrete casting. In a study by [50], the authors give two examples of using 3D printing to create large-scale structural elements. Both printed elements have a hollow structure to be filled with high performance concrete with fiber reinforcement or an insulating material, such as foam used as a thermal insulation. Some parts may be left unfilled for communication cables or electrical wires. In such printed walls with internal voids, the thermal insulation properties can be increased by up to 56% compared to classic walls. Also, printed walls with different configurations of voids inside can provide improved acoustic insulation properties of the element by damping acoustic waves passing through it, depending on the geometry of the wall cells and material properties. This is also beneficial to reduce the effect of fire in complicated geometric structures. Based on the results presented in [43,50], it can be concluded that the main interest in the use of additive manufacturing technologies in large-scale construction is not just in the speed of construction or cost reduction; it also improves the characteristics of building elements (for example, thermal insulation or sound insulation), mainly due to the smart use of the geometry in printing structural elements.

3. Types of Printers

3.1. Robotic Arm Printing for Construction Application

Large-scale 3D printers can be roughly divided into two categories: robotic arm printers and gantry printers. Printers in the first category use a multi-axis robotic arm with a print head [51–53] and the principle of operation of such printers is the same for all types of applications. The choice of robotic manipulators for 3D printing seems obvious since these industrial robots are available and not too expensive. They also provide high accuracy and dynamics and are easy to control due to advanced software. The examples of

concrete 3D printers with a robotic arm for construction application, described below, are shown in Figure 2a–d.

The robotic arm system is relatively new compared to gantry printers. Such a system makes it possible to print more accurate and detailed objects using the tangential continuity method [54]. The tangential continuity method provides a smoother transition between print layers, maintaining a constant rate of change in curvature, providing a more aesthetic appearance. Robotic arm printers benefit from more flexibility with a full 6 degrees of freedom versus 3 or 4 degrees of freedom in a traditional gantry system.

In construction applications, the advantage of these printers is their mobility; they are suitable for printing multiple units together. There are modifications of construction printers with a robotic arm, which are equipped with wheels for easy transport of the printer itself before and after printing [53]. It should be noted that the size of the printer and the weight of the printhead of such printers are limited, that is, they are not suitable for printing large-scale monolithic buildings, only individual elements. To increase the print space, robotic arm printers can be placed on an optional system to make the robot more mobile. But in this case, the question arises about the control and quality of printing, since the robot additionally moves in space [36]. It is also worth noting that only materials with a fine aggregate are suitable for printers with a robotic arm, the use of a coarse aggregate is problematic [47]. One type of printer with a printing robotic arm is a large on-site mobile truck-based printer, which has an enlarged printing arm mounted on the machine. This printer allows for the use of coarse aggregate, but this technique is still under development.

A large-scale concrete 3D printer, CONPrint3D, was created in Germany by the collective work of three institutes at TU Dresden [36], this printer is shown in Figure 1a. Its main difference from smaller-scale 3D printers used in construction is the adaptation of concrete 3D printing to modern architecture and building design. This means that such a printer is not designed for printing thin parts with complex geometry, which is rarely used in ordinary construction. CONPrint3D is designed for monolithic structures with sharp corners and predominantly straight walls. Also, to create such a printer, conventional construction equipment is used as much as possible, which means that there is no need to create new expensive equipment. CONPrint3D envisions retrofitting conventional construction machines with a mobile concrete pump for use as a 3D printer. The concrete conveyor is on board the machine and the boom serves as a robotic arm controlled by the printing algorithm. Regarding the materials used, in such a printer it is possible to use a concrete composition that meets existing concrete standards. That is, CONPrint3D uses concrete with a coarse aggregate, up to 8–10 mm in size. In addition, printing can be done with high-performance concrete, aerated concrete, and concrete with fiber reinforcement. It prints with good surface quality and accuracy/tolerances, in line with current regulations, which is especially important for printing flat walls and sharp corners in general mass construction. The increased size of the nozzle makes it possible to print a layer with a cross-sectional size of 150×50 mm at a printing speed of up to 10 m/min. The print head is equipped with forming plates, which produce an even and smooth surface of the printed layer. Regarding reinforcement, CONPrint3D developers are still working on this issue.

An interesting example of a concrete printer with a robotic arm from the Russian company Apis Cor [44,55] is shown in Figure 2b. A robot with a swivel arm, which is installed in the center of the printed object, has variable dimensions in height and width due to sliding mechanisms. The outreach of the printing mechanism is up to 8.5 m. By using of such a printer, it is possible to print an object with an area of up to 130 m^2 . To print buildings one floor at a time, the printer is capable to move to the next floor. Such a printer provides good controllability and printing accuracy. The Apis Cor printer printed a two-story office building in Dubai [56] 9.5 m in height and 640 m^2 , which was the largest printed building in 2019 [57]. At the moment, the company is aiming at creating buildings beyond the Earth, developing new spaces and using extraterrestrial materials for construction [58].

As already mentioned above, the main obstacle to the mass use of 3D printing technology in large-scale construction is the limitations on the size of printable objects due to printer

configurations. When using robotic-arm printers, the size of the object is limited by the reach of the robotic arm with the print head. Zhang, Li, Lim, Weng, Tay, Pham and Pham [54] propose the following approach to address this scalability problem. Printing is carried out by a team of several mobile robots, whose work is strictly coordinated (Figure 2c). Such a system could potentially print an object of arbitrary size, depending on the number of robots. Some other challenges arise, such as ensuring that all robots work together to ensure full compatibility of printed elements, synchronous mixing and delivery of print media, and collision-free planning of robots. Each robotic arm in the setup consists of a mobile platform, a six-axis robotic arm equipped with an extruder, a stereo camera, and a pump. The system allows the use of two separate materials, which demonstrates the system's adaptability to print multiple materials if required. The printed materials used are ordinary fine-grained concrete and concrete reinforced with fiber. The operation and settings of such a printing system are described in detail in [54].

There are other approaches to increasing the productivity and mobility of robotic arm printers. For example, Keating, Leland, Cai and Oxman [59] describe the design of a concrete 3D printer with a robotic arm, which was installed on a tracked mobile platform for on-site fabrication of printed structures. In the paper, the authors describe the printing of an element with a diameter of 14.6 m and a height of 3.7 m, which was successfully manufactured at the construction site using additive manufacturing; the production time spent was less than 13.5 h. Among other things, such a system has solar panels to recharge its electric drive system, that is, it is completely autonomous and not dependent on external energy sources (Figure 2d).

Industrial robotic arms are also implemented in metal 3D printing processes such as Wire-and-Arc Additive Manufacturing (WAAM). For this technology, the basic set-up consists of multi-axis robotic systems integrated with off-the-shelf welding equipment (Figure 2e).

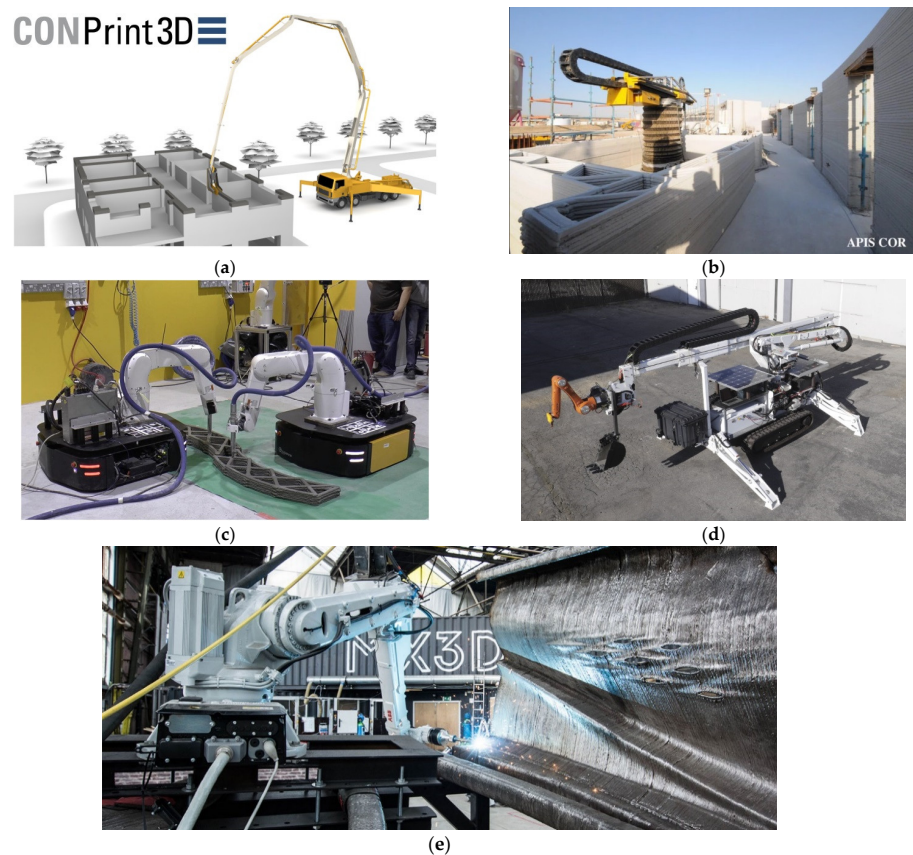

Figure 2. Examples of robotic arm 3D printers (with permission from [36,54,59–61]). (a) Printer CONPrint3D, (b) Printer Apis Cor, (c) 3D printing by a team of mobile robots, (d) Tracked mobile platform 3D printer, (e) MX3D printer for WAAM.

3.2. Gantry Concrete 3D Printing for Construction Application

Gantry concrete 3D printers are the most common and have been more extensively researched than robotic arm printers. The gantry robot printing method is characterized by simple linear axis control and high precision. These relatively simple handling systems provide good access to the printable object while making the most of the available workspace. The advantage of gantry printers is the increased size of the print area, which allows the construction of small buildings as a whole, as well as the use of concrete with the inclusion of coarse aggregate [47]. The disadvantage of gantry 3D printers in comparison with robotic-arm printers is limited mobility and the need for assembly/disassembly of at each construction site. Due to the design of gantry printers, they should always be larger than the object to be printed, since the printing takes place within the area of the printer frame. This means that before starting the printing process, a printer must be installed, and its dimensions must be larger than the entire building. This causes issues when printing buildings on a large scale. In addition, gantry printers are stationary systems, so the production of even a small building requires a lot of effort in assembling and disassembling the printer itself. Therefore, some projects use gantry printers to print individual building elements, which are then assembled at the construction site or in a factory. This can have a negative effect on economic efficiency, as there are additional costs for transportation and assembly of individual elements [36].

Below there are examples of well-known gantry concrete 3D printers; their images are shown in Figure 3a–e. The most famous examples of gantry printers are Contour Crafting and Concrete Printing [54,62,63]. These printers use a layer-by-layer extrusion method [54,64]. The pioneer in construction 3D printing is the Contour Crafting company, which developed a construction 3D printer back in 2004 [16,65], shown in Figure 3a. Printing is based on the creation of two layers of material for the construction of a kind of formwork. Such a printer uses a number of gantries, since the print head of the 3D printer is installed on an overhead crane. The developers of this printing method also propose to use the printer not only for ordinary construction on Earth, but also outside it, for example, when exploring the Moon or Mars [66].

The printer developed at Loughborough University [67], Figure 3b, has the same printing principle. This project, unlike contour crafting, uses high-performance concrete. The high mechanical properties of such a material in combination with a relatively small nozzle diameter (4–6 mm) give good control in terms of the geometry of the printed element [50,63]. The gantry frame of the printer measures 5.4 m(L) × 4.4 m(W) × 5.4 m(H) [68], which also limits the size of the printable elements, that is, this printer is not designed to print entire buildings, but only individual elements and small architectural forms.

A classic example of a gantry concrete 3D printer for large-scale construction is the product of the Russian company Spetsavia [69]. The company presents a line of construction 3D printers of various configurations, from small printers for laboratory printing and printing of small architectural forms, to large-scale printers capable of printing an entire building. The company claims that the AMT S-500 configuration printer, Figure 3c, is the largest construction printer in the world, capable of erecting buildings up to 80 m high. The base printer is 14 m high, which can print a 5-story building; the height can be increased if necessary. The maximum area of a printed building is 340 m². The size of the print head allows printing with ready-mixed concrete with an aggregate size of up to 6 mm. The maximum dimensions of the printed layer are 30 × 80 mm, with positioning accuracy of up to 2 mm.

Another example of large-scale construction printers are the crane printers from the Italian company WASP [70]. The history of the company begins with small printers for printing with bioplastics; at the moment the company has in its arsenal a construction 3D printer for printing large-scale objects, shown in Figure 3d. It is a modular printer consisting of a metal frame that can change its configuration. The printing area in the first configuration is 50 m², and in the extended one, more than 100 m². Printing can be done by several modules connected together. The size of one module is 6.6 m in diameter and 3 m in

height. Additional WASP modules when working together have a potentially infinite print area. The diameter of the nozzle hole is from 18 to 30 mm; printing can occur both with cement mortar and geopolymers and even with an earth-based material. The company is currently building sustainable housing in a new circular shape made entirely from recycled and recyclable materials sourced from local soil. This material has zero carbon emissions and is adaptable to any climate and conditions [71].

The development of concrete 3D printers from the Danish company COBOD looks quite promising. Their construction gantry 3D printer BOD2, Figure 3e, also has a modular system that allows creating objects of any size [72]. The developers claim that the largest configuration of printing units can build a multi-storey building with an area of more than 1000 m². The company also offers smaller printers with a printable area of up to 50 m², depending on the customer's requirements. Each module is 2.5 m long and can move along any of three axes. The advantage of the modular system is that, in addition to the practically unlimited print area, it makes it possible to customize the printer for each project, regardless of the size and shape of the building being erected. In the printer specification, the maximum print length is indicated as: "as long as you like" [73]. The light weight combined with the incredible rigidity of the truss ensures a tough, robust construction that will withstand rough handling and ensure consistent and reliable printing year after year. As a material, the developers offer ordinary concrete with coarse aggregate. Recycled materials such as broken roof tiles can be used as coarse aggregates.

The construction 3D printing company ICON is actively developing in the USA. The ICON Vulcan gantry construction 3D printer, Figure 3f, is capable of producing reliable single-storey houses faster than traditional methods, with less waste and more design freedom [74]. The printer is capable of erecting buildings up to 3.2 m in height and 11 m in width, the length of the printed object is not limited. The undoubted advantage of this printer is controllability through an intuitive and simple application from a smartphone or tablet, which definitely brings the construction industry of the 21st century into the era of digitalization. The printing material is the so-called Lavacrete, a high-strength concrete that can withstand extreme weather conditions and significantly reduce the impact of natural disasters while ensuring maximum efficiency. The composition of this material has not been disclosed. Among the latest news from this company was the announced construction and sale of a complex of four highly efficient individual houses using the construction 3D printer ICON Vulcan [74]. The home sale announcement was posted in March 2021, with two out of four homes sold within days of the start of sales. The company notes the overwhelming consumer demand for such houses, which is proof of the relevance of the entry of construction 3D printers into the large-scale printing market. It is also noted that using construction 3D printing technologies, such an acute social problem as the housing crisis can be solved in the country. In addition, the company is involved in two projects for the development of territories outside the Earth—the construction of dwellings on the Moon and Mars [74], using the soil available on these space objects as a printing material.

The German company PERI has been engaged in efficient, fast and safe construction since 1969 [75], and has recently been using construction with 3D printers. This once again confirms the relevance of using construction 3D printing in the world market, when such large construction companies keep up with the times and switch to new technologies. In November 2020, the company announced the construction of the first multi-storey apartment building in Europe, thus proving that 3D printing is also suitable for the construction of large-scale housing [76]. The company firmly believes that the use of concrete 3D printing technologies will revolutionize the construction industry with its ability to accelerate the industrialization of the construction process.

Probably the most famous and recognized company in the world concrete 3D construction market is WinSun from China, which has existed since 2003. It was they who implemented a number of buildings using a 3D printer in the period from 2008 to 2014, before anyone else in the world [77]. The company has more than 20 projects implemented using 3D printing not only in China, but also abroad [78]. Among the company's achieve-

ments are the construction in 2015 of the highest 3D printed house at that time [78], the development of the first material and nozzles for construction 3D printing, the development of a 3D printer that can continuously print construction products, and the development of the world's largest architectural 3D printer [78]. Currently, the company is engaged in printing not only buildings (Figure 3h) and small ancillary structures, but also water conservancy facilities [79], sound barriers, fences with green spaces, and elements for coastal development [80]. The characteristics of the 3D printer used, as well as the composition of the print material, are not disclosed.



(a)

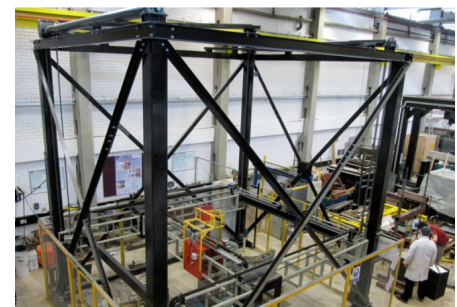

(b)



(c)

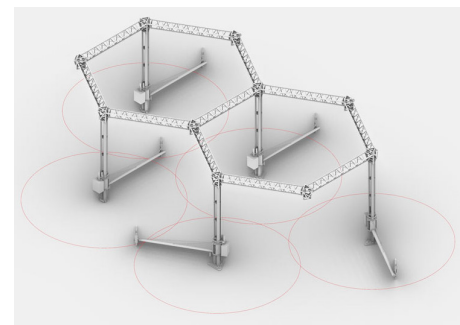

(d)



(e)



(f)



(g)



(h)

Figure 3. examples of gantry 3D printers (with permission from [62,69,70,72,74,80–82]). (a) Printer Contour Crafting, (b) Printer of the Loughborough University, (c) Spetsavia's AMT S-500 printer, (d) WASP crane 3d printer module system, (e) BOD2 printer, (f) ICON Vulcan printer, (g) Peri 3D concrete printer, (h) WinSun 3D printed building complex.

4. Materials

4.1. Cementitious Materials

Materials for construction 3D printing with concrete can be: 3D printed cement concrete, 3D printed geopolymer, 3D printed concrete reinforced with fiber, fast hardening 3D printed material, and 3D printed material based on earth [54]. For 3D printing concrete, the following basic concepts are introduced: extrudability, buildability, and open time [47,83,84].

- Extrudability—the ability of a material to be extruded through a nozzle with minimal energy consumption. It depends on yield stress, plastic viscosity, and the resistance of concrete to drainage/filtration of mixing water.
- Buildability is the ability of the formed layer of print material to maintain its geometry (shape and size) in a fresh and transient state under increasing load [85]. For this, the concrete for printing must exhibit sufficient static yield strength and curing rate during settling. In addition, the material must develop mechanical strength and plasticity modulus in accordance with the selected printing speed.
- Open time of 3D printed concrete—a limited period between the beginning of cement hydration and the moment when the mixture becomes too hard for extrusion [86].

In addition, there is the concept of printability, which combines all these requirements for printed concrete. That is, if the concrete meets all of the above requirements, then it can be considered suitable for printing, that is, it is printable. All of these requirements depend on the rheology of the concrete mix. Important for printing are such rheological properties as the time-dependent static yield stress, dynamic yield stresses, structuration rate and plastic viscosity [36]. The static yield stress is especially important as it determines the stability, shape and size of the printed layer stack, and the ability of the printed layers to support the weight of subsequent printed layers. Thus, high yield strength is recommended for printed concrete. The rheological parameters of the concrete mix can be controlled by chemical additives such as superplasticizers, viscosity modifiers, set retarders and accelerators. By using additives, it is possible to give the concrete mixture the ideal consistency, while maintaining workability and buildability for longer periods of time. Superplasticizers are used in concrete production technology for 3D printing in order to make the slurry more fluid during pumping and then quickly recover its shape after printing to maintain the next printed layer [86].

Traditional concrete does not meet the rheological requirements for 3D printing. Therefore, researchers are trying to optimize the properties of freshly mixed concrete to make it printable, most often replacing coarse aggregates with fine ones (sand, clay, fly ash, silica fume). However, due to the fact that there is no coarse aggregate in such concrete, the concrete is susceptible to shrinkage, as a result of which the printable concrete is susceptible to cracking. The solution could be fiberglass or shrinkage reducing additives [86,87]. Concrete for printing should have a thick consistency, the thicker the better, but at the same time, it should be suitable for pumping. The easiest way to change the consistency or workability of concrete is to measure the slump. In studies [86,88], the authors use just such a method to determine the pumpability and buildability of a printing mix. They determined that compositions with 4–8 mm slump and 150–190 mm slump flow show sufficient buildability and good geometric accuracy.

According to [36], concrete is considered suitable for 3D printing if:

- it is continuously and effortlessly extruded for a long time;
- it is buildable to the design height, taking into account the economic viability of the intended purpose;
- it has a sufficiently high compressive and flexural strength, also considering the intended purpose.

Mechtcherine, Nerella, Will, Näther, Otto and Krause [36] transfer these requirements to coarse aggregate concrete, as most research has been done on fine grained mortars, and the rheology of 3D printed coarse aggregate concrete is still poorly understood.

Examples of compositions for construction 3D printing with coarse and fine aggregates are presented in Table 1. The compositions often use such diverse materials as fly ash [89,90], silica fume [91,92], and nano-clay [93–95], as an additional binder as a replacement for part of the cement and to give the mortar plastic properties [62].

Table 1. Examples of compositions for 3D printing.

Material *	Mechtcherine et al. [36]	Ji et al. [96]	Zhang et al. [24]	Kazemian et al. [97]	Le et al. [62]	I. Agustí-Juan et al. [98]	BOD2 Specifications [99]
Cement	1	1	1	1	1	1	1
Add. binder (fly ash, silica fume)	0.7	0	0.56	0.11	0.43	0.087	0
Fine aggregate (0–2 mm)	3.37	3.2	1.25	2.51	2.14	1.41(0–4 mm)	0.57
Coarse aggregate (2–8 mm)	1.13	3.62	0	0	0	2.2 (4–8 mm)	1.29 (0–8 mm)
Water	0.51	0.66	0.66	0.48	0.4	0.34	0.27
Additives	0.014	0.024	0	0.0016	0	0.009	0.0098

* consumption is given in proportions relative to cement.

The use of a large amount of cement material for 3D printing in construction and the desired requirements for fast setting and early strength development lead to increased heat generation during hydration, which in turn can provoke the appearance of microcracks in the printed layers due to thermal stress and shrinkage [100]. Such microcracks can seriously affect the durability and safety of the structure. Thus, concrete material for 3D printing is more prone to shrinkage cracking than ordinary concrete for casting [101]. In Wang, Ma, Li, Ma and Guan [100], the authors use a mixture of high belite sulfoaluminate Portland cement and cement with low heat release as a binder for 3D construction printing, and study the properties of such a material for rheological stability, shrinkage and applicability for large-scale construction printing in general. In a mixture with such a binder, a 37.8% decrease in heat release at the early stages of hydration is noted compared to a mixture where only ordinary Portland cement is used, which is an advantage for reducing the occurrence of shrinkage cracks. The addition of silica fume in the amount of 10% leads to an improvement in printability, as it increases the static yield strength and decreases the plastic toughness. In terms of strength characteristics, the mixture can also be considered suitable for 3D printing (compressive strength at the age of 1 day corresponds to 30 MPa). The sulfoaluminate high belite cement is effective in improving the drying shrinkage resistance of the composite material. A 60% reduction in drying shrinkage is observed with the addition of 80% high belite sulfoaluminate cement as a binder. The mixture was used to print a large-scale 9.4 m long arch element with high print quality, high volumetric stability and no shrinkage cracks [100].

4.2. Wire-and-Arc AM

In order to realize real-scale structural elements without ideally any geometrical constraints either in size or shape, the most suitable manufacturing solution for metallic elements is the so-called Wire-and-Arc Additive Manufacturing (WAAM) process. This technology consists of a combination of an electric arc as heat source and wire as feedstock. It currently uses off-the-shelf welding equipment, such as welding power source, torches and wire feeding system, while motion is provided by either a robotic arm or computer numerical-controlled gantries. Such a flexible building set-up allows for the realization of elements without theoretical dimensional constraints. Thus, it appears more suitable for structural engineering applications. The outputs requested are in the order of several meters (typically 3 to 5 m long) (Figure 4).

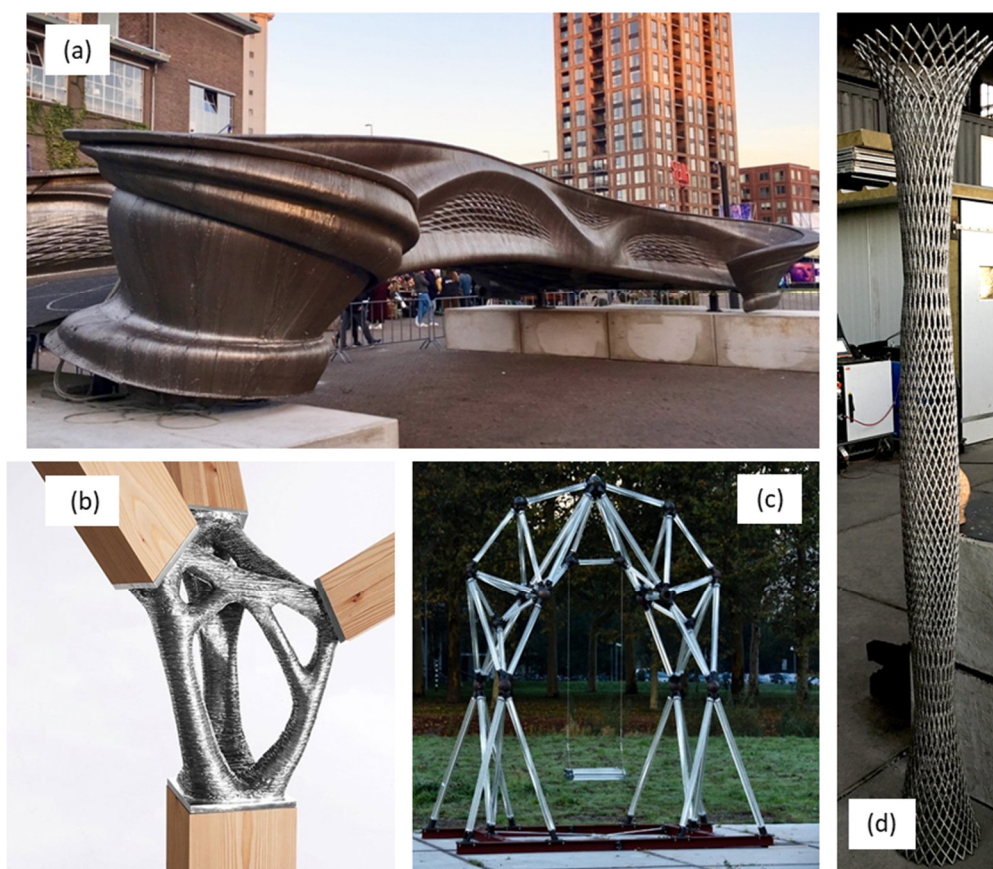

Figure 4. Applications of the WAAM process in construction: (a) MX3D Bridge; (b) Takenaka connector; (c) Glass swing by TU Delft; (d) WAAM diagrid column by the University of Bologna.

WAAM's layer height is commonly in the range of 1 to 2 mm, resulting in expected surface roughness of about 0.5 mm for single track deposits. As a result, this process is not considered net shape, as machining is required to finish the part, thus being better suited for low- to medium-complexity and medium- to large-scale elements, such as those implemented in structural engineering [102–104]. Indeed, in order to obtain pieces of large dimensions, higher printing velocities are required, resulting in larger geometrical imperfections with respect to the digital model. Therefore, much effort is needed for a proper assessment of both the geometrical and mechanical characterization of the outputs from the Wire-and-Arc Additive Manufacturing (WAAM) process.

WAAM technology can be used for different types of metals, ranging from bronze to aluminum, from titanium to steel alloys. Nowadays there is limited amount of research concerning the influence of WAAM process parameters on the material properties [105,106]. Among WAAM-processed stainless steels, the available literature reports limited data about maraging steel [107], 2Cr13 martensitic stainless steel [108] 316L and 304 L austenitic stainless steels [102,103,109–112], as well as 2209 duplex stainless steel [113]. The presented results are focused on the assessment of the influence of the orientations with respect to the deposition layer on the tensile strength (yielding and ultimate tensile strengths) of WAAM metallic specimens, hence confirming the interest in studying the anisotropy of the printed outcomes. In the work done by Gordon and co-authors [110], Young's modulus values are reported, indicating values around 130 to 140 GPa, which are significantly lower than that registered by the conventional wrought material (about 190 GPa). Wu, Pan, Chen, Ding, Yuan, Cuiuri and Li [114] found a first correlation between the tensile strength and the specimen's orientation, in terms of grain growth orientation.

4.3. Composite 3D Printing Materials

A composite structure consists of two or more materials, and can be composed of different types of structures, not just for construction purposes but also for different types of applications. In the construction sector, there are many types of concrete materials; this material can by itself make a composite structure, such as self-compacting concrete, normal concrete, high early-strength concrete, and ultra-high performance concrete. There is a study that focused on the use of different types of concrete to make structural elements using 3DP technology. For example, ApisCor [56] used hardened 3DP UHPC in normal concrete as a reinforcement; the printed UHPC has an effect like a steel bar to improve bending capacity inside the concrete. The result of their study shows that the flexural strength increases by 160.5% by using UHPC as a reinforcement element.

Another study by Bhattacharjee, Basavaraj, Rahul, Santhanam, Gettu, Panda, Schlangen, Chen, Copuroglu and Ma [23] focused on engineered cementitious composites (3DP-ECC). An ECC usually consists of cementitious materials with a certain amount of fibers in the materials mix. Their results showed that ECC has more ductility than conventionally printed parts. ECC also showed a strain hardening behaviour, with a strain capacity of 3%. However, the composite materials are not limited to fibers; it is possible to print wire steel via a robotic arm and then start printing the concrete materials surrounding it to complete the structural elements.

Previous studies showed the most favourable method to proceed with composite materials. Figure 5 shows the most effective method that could be a future means to industrialize digital concrete with steel reinforcement.

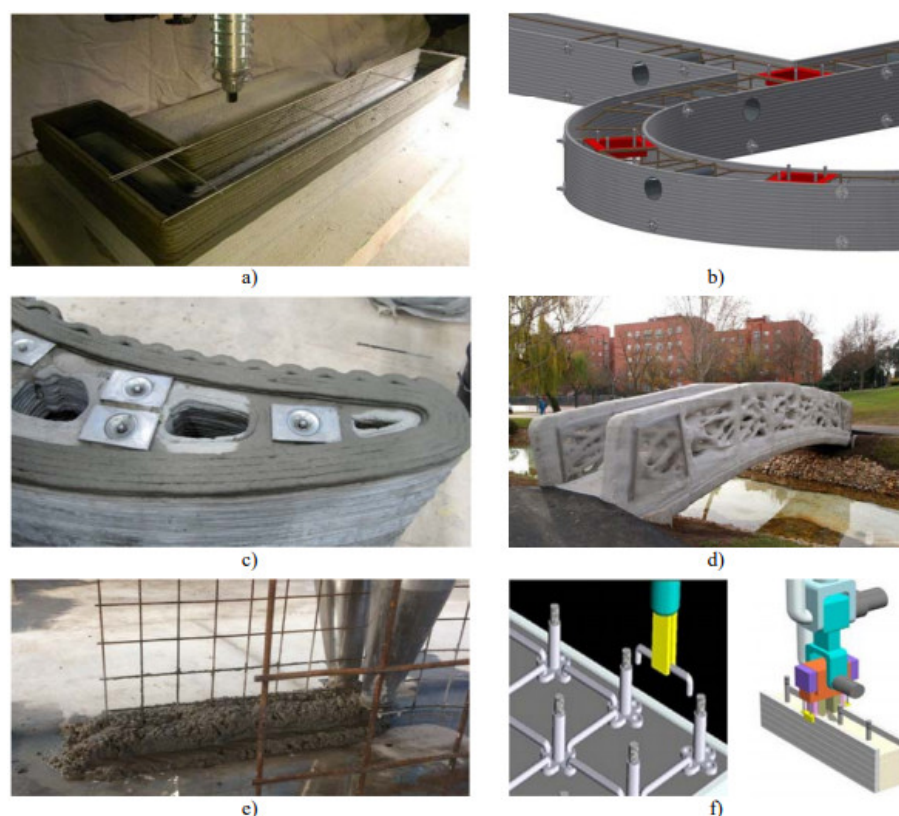

Figure 5. Reinforcement-incorporating techniques in DC: (a) placing steel reinforcement horizontally between 3d-printed concrete layers (with permission from [115]); (b) placing vertical reinforcement in 3d-printed formwork which will be filled with flowable or vibrated concrete (with permission from [44]); (c) post-tensioning of steel reinforcement placed in 3d-printed conduits (with permission from [68]), (d) pre-stressed bridge constructed based on selective binding [116]; (e) enveloping steel reinforcement with concrete (Photo: V. Mechtcherine); and (f) fully automated placement of pre-fabricated metal reinforcement elements (with permission from [16]).

These proposed processes shown in Figure 5 are only simple illustrations of the 3DP technique used for concrete with steel reinforcement. These processes can be developed using two robotic arms: one arm to print the steel reinforcement, and then the concrete is printed later using the other arm to complete the composite structure, which assists to enhance mechanical strength.

5. Three-Dimensional Printing Process

Large-scale construction printing consists of the following steps: model creation, material production, transportation, layer-deposition, and quality control.

Any method of 3D printing at the first stage consists of translating a 3D model into 2D with a breakdown of the printed element into layers. For large-scale 3D printing, the tangential continuity method is used, since the printed layers of cement material are actually three-dimensional, that is, they are made of non-planar layers with locally varying thickness; therefore, it is better to use the geometric capabilities of 3D printing technologies. Using the tangential continuity method for slicing allows full use of the possibilities of 3D printing by creating layers of different thicknesses, which leads to obtaining vaulted, mechanically stronger structures in terms of design. The obvious advantage of this strategy is to maintain constant contact surfaces between the two layers, avoiding geometric gaps between the two layers, which often limit the capabilities of the additive manufacturing process [50].

For large-scale on-site printing, concrete can be delivered ready-made from the factory. While thixotropic concrete with high yield stress and zero slump can be used in lab or object printing on small printers, this approach is not applicable for large-scale printing due to the potential interruption of the process and the high concrete pumping pressure required. In this case, the concrete can lose its required properties and become unsuitable for printing. In this case, an additional step of mixing the material is necessary after transport and preferably after pumping. A suitable solution would be to introduce accelerators into the concrete just before extrusion, i.e., through an additional rotor in the print head.

Quality control, in turn, is divided into control of fresh concrete and hardened concrete. The success of all printing processes depends on the concrete rheology, which is measured at the fresh concrete stage and throughout the entire printing process [36]. Optimum media testing methods should be in-line and continuous to account for and control changes in rheology during the printing process. CONPrint3D has proposed such a continuous method for quantifying the extrudability of a material, using the 3D printer itself as a testing device [36]. The energy expended in extrusion is measured to determine the extrudability index and the unit of extrusion energy. The lower this unit of extrusion energy of the material, the higher its extrudability. Thus, the optimal compositions are determined using a parametric study.

Often, researchers involved in testing materials for construction 3D printing are forced to resort to developing their own test methods [117–120], which differ from the existing ones and may even take into account the cost of construction [121].

The principal differences in the printing process for robotic arm printers and gantry printers are shown below.

5.1. Robotic Arm Concrete 3D Printing for Construction Application

An example of the operation of a printer with a robotic arm is shown in Figure 6.

Most commonly, robotic arm concrete printers consist of a print head mounted on a robot, as well as two peristaltic pumps, one for the premix and one for the accelerator, and a mixer for the premix, where all the three latter parts are removed from the robot arm. A microcontroller is used to control the pumps and the print head; control is carried out through the program, depending on the printing path, in order to be able to dose additives and emergency stop the printing process [50].

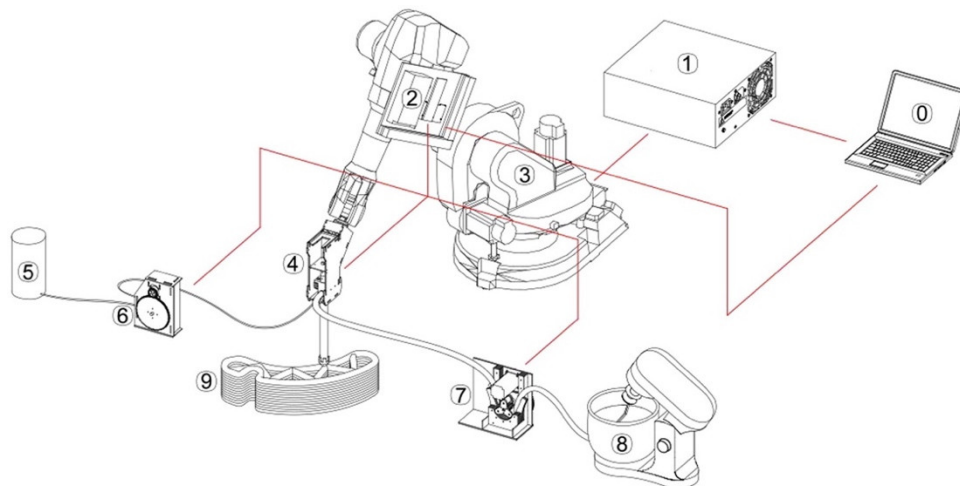

Figure 6. Printing process using a robotic arm printer for setting on-demand concrete (adapted from [50]). The numbers indicate the following elements: 0—system command; 1—robot controller; 2—printing controller; 3—robotic arm; 4—print head; 5—accelerating agent; 6—peristaltic pump for accelerant agent; 7—peristaltic pump for premix; 8—premix mixer; 9—3D printed object.

The prepared mortar premix with pumpable rheological characteristics, i.e., fine particle size distribution, low critical shear stress, and slow hardening quality, is stored in a shear mixer to avoid early hardening due to its thixotropic properties. Then the prepared mixture is fed by a peristaltic pump to the mixing auger located inside the print head. At this stage, additives are introduced into the mixture to speed up the process of recruiting the required mechanical properties immediately after extrusion [50]. Then the finished mixture is extruded along the contour specified by the CAD model.

5.2. Gantry Concrete 3D Printing for Construction Application

An example of the printing process on a portal concrete 3D printer is shown in Figure 7.

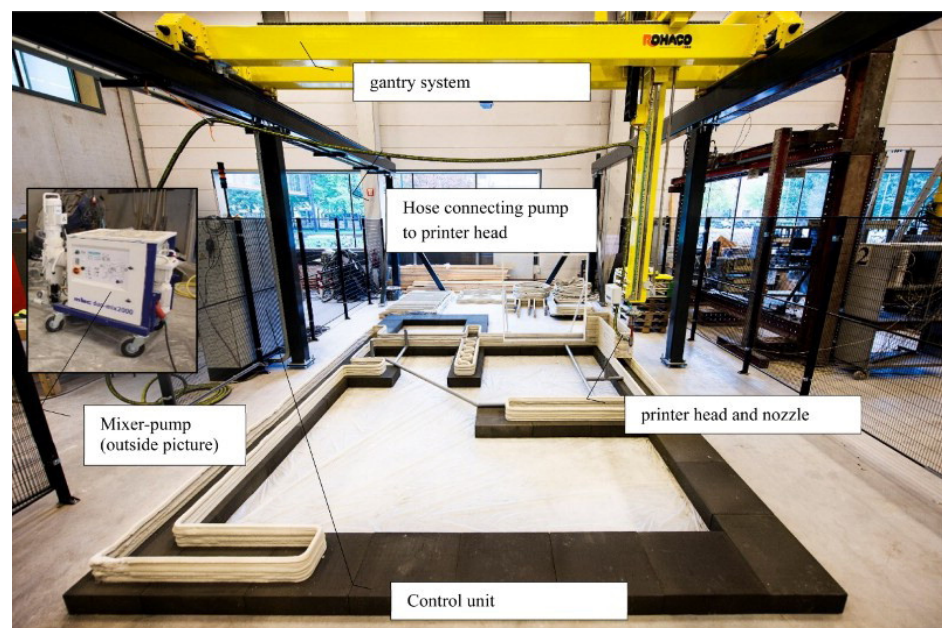

Figure 7. Printing process using gantry printer (TU Eindhoven) (adapted from [122]).

All gantry concrete 3D printers, regardless of the size of the printed element, consist of the following main elements: the gantry system itself with a print head and nozzle

installed on it, a mixer pump for preparing concrete and pumping it into the print head, a hose connecting the mixer and the print head, and a control computer to accompany and control the printing process. Concrete under pressure is fed into the print head, where it is squeezed out through a nozzle to create the desired shape along a predetermined contour.

The Danish company COBOD compared gantry 3D printers and printers with a robotic arm and noted the advantages of gantry printers. It is noted that gantry printers of a modular system can have an almost unlimited print area and can print an entire building, which no printer with a robotic arm can boast of. But at the same time, robotic printers are more mobile and easier to move than gantry ones; they can be used to create more accurate and geometrically complex elements. The full text of the comparison of the two types of printers is presented in [123]. Table 2 shows the detailed description of different types of printers that could be used in the construction industry.

Table 2. Types of printer that have been used for large-scale construction.

Types	Variation	Examples	Advantage	Disadvantage
Robotic Arm	Construction machines with a mobile concrete pump	[36]	<ul style="list-style-type: none"> • mobility • availability and low cost of industrial robots • high accuracy and dynamics • easy to control due to advanced software • flexibility with a full 6 degrees of freedom 	<ul style="list-style-type: none"> • limitations on the size of printable objects • ability to print only individual elements • need for assembly/connections of individual printed elements • the need for programming skills to ensure 6 degrees of freedom
	Ordinary robotic arm	[44,55]		
	Team of mobile robots	[54]		
	Mobile platform robot	[59]		
	Mobile robots climbing system	[124,125]		
	Mobile platform robot	[124,126]		
	Mobile platform robot	[127]		
	Mobile platform system	[59,128]		
	Mobile printing unit on flatbed trailer	[129]		
Gantry	Ordinary gantry system	[62,130]	<ul style="list-style-type: none"> • simple linear axis control • high precision • increased size of the print area • simple 3D printer software • ability to print entire buildings in one go • ability to using coarse aggregate • the ability to print unlimited-length elements • the ability to control the material flow by applying a hopper above the printhead 	<ul style="list-style-type: none"> • limited mobility • need for assembly/disassembly of each at the construction site • bulkiness
	Ordinary gantry system	[13,14]		
	Ordinary gantry system	[63]		
	Ordinary gantry system	[69]		
	Crane printer, modular system	[70]		
	Modular system	[72]		
	Two-column gantry system	[74]		
	Ordinary gantry system	[75]		
	Ordinary gantrysystem	[77]		
	Ordinary gantrysystem	[127]		
	Ordinary gantry system	[131,132]		
Ordinary gantry system	[129,131]			

5.3. Wire-and-Arc Additive Manufacturing

Research on the WAAM process involves the feedstock, the optimal process parameters, i.e., the printing strategy. The feedstock, in the form of a wire, can be deposited according to different paths and strategies by varying the main process parameters (arc current and voltage, arc transfer mode, speed). The deposition process involves complex thermo-physical phenomena, while the solidification conditions promote a microstructure with large columnar grains [133,134].

Current WAAM techniques use MIG/MAG power sources. Besides traditional synergistic machines, Cold Metal Transfer (CMT) allows a step further in terms of heat input

optimization. Modern CMT sources are also characterized by Cycle Step technology with controlled single spots deposition.

Both traditional synergistic and CMT solutions have been investigated in the literature [135–137], even though limited studies focused on the influence of WAAM process parameters on microstructural and mechanical properties [106,138].

The layer-by-layer continuous printing strategy consists of depositing successive layers of welded metal one over the other to create planar or extruded elements with constant thickness. The fundamental process parameters are (i) the current and its voltage, (ii) the wire diameter, (iii) the wire-feed rate, (iv) the welding speed, and (v) the vertical printed layer height. The combination of such controlling parameters affects the printing quality (geometrical precision and surface roughness) as well as the material's mechanical properties. For structural engineering applications, the need for high welding velocity for a rapid realization of structural elements of such proportions plays a crucial role for the specific characteristics of the printed parts, as it induces geometric inaccuracy of the outcomes, both in terms of surface roughness and lack of straightness of the elements. For a given element to be printed, a digital model, from which the printing head reads the coordinates of the points defining step-by-step the position of the welded layer, is created with Rhinoceros software (Rhinoceros 5). However, due to the intrinsic inaccuracy of the printing process, each point of the digital model has a real counterpart whose position is not exactly the one of the digital model, as it is affected by error.

Therefore, when dealing with WAAM-produced structural elements it is necessary to first codify specific issues related to: (i) the set of process parameters; (ii) the wrought material; and (iii) the printing strategy. Furthermore, given the novelty of the process, especially for structural engineering applications, there is a very limited database of experimental results to provide sufficient information on the structural response of WAAM-produced metallic structural elements.

5.4. Composite Structure 3D Printing

Printing processes for concrete and reinforcement of structural elements would be more suitable when the robotic arm is used as a setup; however, the gantry systems could be applicable as well for structural elements, but might face difficulties while printing. These difficulties could be due to movement in the joints of the gantry.

For printing concrete, it is necessary to have a proper pumping system with delivery pipes, and for reinforcement it is necessary to have proper materials and delivery systems attached to the robotic arm.

Figure 8 shows an example of printed concrete and printed steel; this is an excellent instance to have both printing materials in one package as fully printed structural materials. This may have some issues such as heat from the printed steel causing an issue with the fresh state of the printed concrete; therefore, it might require a pause between each of printed materials.



Figure 8. Left side image shows printed concrete (adapted from [139]), right side image shows a printed steel structure (adapted from [140]).

Another example is provided by the FloWall concept proposed by the ITE department at TU Braunschweig, Germany. The idea lies within the “reinforcement supports concrete” approach, in which WAAM reinforcement is printed before shotcrete 3DP is applied [141].

6. Mechanical Properties

6.1. Robotic Arm and Gantry Concrete 3D Printing for Construction Application

Anisotropy of properties is noted in structural elements created using concrete 3D printing. First of all, this concerns the strength characteristics of concretes for construction 3D printing. Since in 3D printing the creation of an element occurs in layers, the adhesion force between the layers is of great importance, which can be weakened by the minimum contact area of the surface of the layers and reduced bending strength [29]. Accordingly, the direction of printing has a significant effect on the load-bearing capacity of the structure.

The bond strength between layers is greatly influenced by the time between printing two adjacent layers [142,143]. For example, in Taylor Marchment [144] specimens are described in which the time between printing layers was 10, 20, and 30 min. It is noted that the bond strength between layers with a delay time of 10 and 30 min is the same, but more with a delay time of 20 min. Of course, this time cannot be taken as a basis, since each printer and print material has its own characteristics, but this makes it possible to assume that there is an optimal time to create one layer of the structure and to organize and optimize the printing process taking into account this time. It is also noted that there is a relationship between the strength of the adhesion of layers and moisture on the surface of the layer [145]. If the surface of the layer is dry, then it lacks the ability to adhere to the above-printed layer to form a strong bond. The moisture level between layers is a function of many parameters, including the printing process, evaporation rate and spreading rate of mixtures, and this level should be controlled during printing and not allowed to decrease below the acceptable value. This is especially important in large-scale construction, where printing is continuous along the contour of the building, which can be tens of meters. In this case, it may be advisable to print in separate trips, so that the entire contour does not take an unacceptable amount of time to print, at which the moisture content of the layer and, consequently, the strength of adhesion between the layers can decrease. Thus, the bearing capacity of the entire structure, which directly depends on the interlayer bonds, will have fewer risks of reduction.

Anisotropy is noted in the compressive and flexural strength of 3D printed structures [145–149]. It is noted that the highest compressive strength is observed in the longitudinal direction of printing of the layers, the lowest in the lateral direction. This is probably due to the high pressure exerted on the material in the longitudinal direction during the extrusion process. The average strength is found in the direction perpendicular to the printed layers. Flexural strength also showed minimum values in the lateral direction. The decrease in strength in the lateral direction is due to the fact that in this direction it undergoes the least pressure during the hardening process. Without any form or formwork to prevent lateral shear and settlement of the material, fresh concrete is free to settle and expand, causing a weakening of strength in that direction [145]. Compressive and flexural strength, regardless of the direction of application of the load, can be improved by introducing microfiber into the composition of the material for the 3D printing process.

All the above points should be taken into consideration in large-scale construction, since the difference in strength in different directions may be less frequently taken into consideration on a laboratory scale; however, in real mass construction it has a more significant value [150]. This is especially true for structures that are subject to increased lateral loading, sudden temporary lateral loading, or additional bending moment. Introducing reinforced elements increases strength, regardless of the direction of the application of the load, but in a large-scale application, this issue requires additional research. All tests for strength in various directions of load application were carried out on a laboratory scale, mainly on fine-grained mortar, not concrete. However, it is required to conduct more investigation on

3D printed concrete with coarse aggregate (over 4.75 mm in diameter in the particle size counted as concrete).

6.2. Wire-Arc Additive Manufacturing

WAAM leads to a peculiar non-equilibrium microstructure considerably different from that of conventional manufacturing processes. WAAM metal parts are characterized by a hierarchical microstructure whose main features strongly influence their mechanical response, which may significantly diverge from that of conventionally manufactured counterparts. High printing velocity is required for large parts, leading to non-negligible geometrical imperfections. Recent research studies on WAAM stainless steels evidenced a marked anisotropy due to the crystallographic texture induced by the epitaxial growth [102,110,111,151,152]. These issues determine the need for specific testing procedures for WAAM materials, as recently recognized by the F42 Committee on AM technologies of the ASTM International.

WAAM-produced planar elements are characterized by their inherent geometrical irregularities, proper to WAAM layer-by-layer printing process, and specific material behavior, governed by a marked anisotropy. Both issues need to be properly taken into account and fully characterized for the structural design of WAAM-produced elements, as they are both sources of uncertainties which influence the structural response of the designed and printed elements.

The first peculiar aspect when dealing with structural members realized with WAAM process is the geometrical irregularities of the printed outcome.

As far as the continuous printing strategy is concerned, the main issue related to the layer-by-layer deposition is the surface roughness which also causes variation in the thickness of as-built specimens. From planar to tubular geometries, additional irregularities in terms of lack of straightness and out-of-roundness should also be studied.

Therefore, for ready-to-use elements and future applications of on-site metal 3D printing, it becomes crucial to study the geometrical irregularities of WAAM-produced structural elements. First of all, proper characterization of the geometry of WAAM printed outcomes should be carried out. From that, considerations of the possible influence of these irregularities in the mechanical response of the printed specimens should be analyzed as well.

The limited literature focused on this innovative process slightly emphasizes the possible anisotropy induced by the process in the tensile properties of WAAM printed outcomes [102,103,108,110,111].

Since the manufacturing process may potentially induce orthotropic behavior depending on the orientation towards the printing direction and the presence of surface roughness resulting from the printing layers, the mechanical response should be investigated with reference to specimens having different orientation with respect to the deposition layers. Figure 5 qualitatively depicts three different orientations of specimens cut from printed plates: longitudinal direction (L) is taken along the deposition layers, transversal direction (T) is taken perpendicular to them, while diagonal direction (D) is taken at 45° from them (Figure 9).

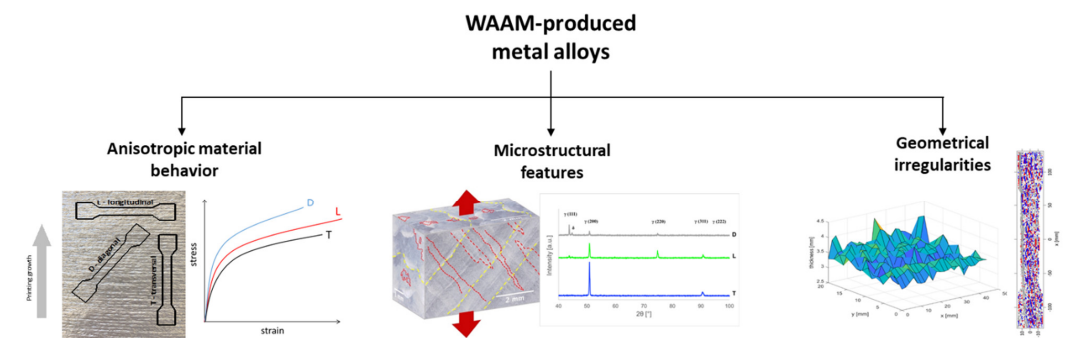

Figure 9. Geometrical and mechanical features of WAAM-produced alloys.

6.3. Composite 3D Printing

The mechanical properties of structural members with composite 3D printed materials, such as concrete with reinforcement materials, are providing robust and better resistance to tensile strength. Overall, having a reinforcement such as fiber not only improves the tensile strength of the structure, but also increases the potential of the strain-hardening behavior [153]. Micro-cable reinforcement is another alternative material that could be used to reinforce concrete and geopolymers [96]. The result from an earlier study showed that the micro-cable could reach the highest flexural strength and increase resistance to deflection.

Having fiber or micro-cable or steel reinforcement definitely improves the mechanical behaviours of structural elements but adding each of the materials in the process of printing is quite different. For example, fibers could be added into the materials mixed through the mixer to the printer. Micro-cable added through the pulley to the printed parts and steel reinforcement could be printed with printed concrete, or held and attached along with the help of robotic arms.

7. Discussion

Concrete and steel 3DP were discussed using different technologies of AM for large-scale construction application. Concrete depends on the mix proportion of the materials and the right ingredients in the mix to create outstanding rheology prior to printing and during the printing process. However, this process is quite different in Wire-and-Arc Additive Manufacturing (WAAM), as the issue of rheology or material proportion is not an issue in this material.

Summing up the results of the review of the applicability of construction 3D printing for large-scale construction, the following benefits of each print type can be drawn:

- The advantage of robotic arm printing is creating precise shapes and geometrically complex elements due to a print head with six degrees of freedom, they are more mobile and transportable, and they can have autonomous power supplies.
- Gantry printing is a more common and applicable method for construction in the additive manufacturing technologies sector. The advantages of gantry 3D printing lie in the ability to create whole buildings, including printing multi-storey buildings, the fairly simple design of printers, and the ability to print simultaneously with several modules, which theoretically makes it possible to print buildings of almost unlimited area and size.
- The transition from a well-studied conventional concrete casting to a new technology for large-scale construction 3D printing can have a number of problems, such as the lack of regulations governing this type of construction, and the need to use coarse aggregate in concrete and structural reinforcement.
- The overwhelming majority of studies of the rheology and mechanical characteristics of concrete compositions for 3D printing are carried out using only fine aggregate in the mix, and also most laboratory 3D printers often have an insufficient nozzle size for extrusion of concrete.
- The question of the reinforcement of large-scale 3D printed structures, or rather the technology of introducing steel reinforcement into the structure during the printing process, remains open.
- As for the strength properties of concrete for 3D printing, anisotropy property in strength depending on the direction of the applied load should be noted. This can be a significant problem and should be considered when structural designing large-scale 3D-printed construction, especially by reinforcing possible weak points or having several forces from different dimensions such as wind and earthquakes.
- Composite 3D printed structures could be possible and viable by having mixed fibers, micro-cables and steel reinforcement for the structural elements.

In terms of composite materials in printing, this type of mixing is more challenging due to considering both materials (concrete and steel) which require the proper rheological mix in the concrete and the proper fuse of WAAM materials. An additional challenge is

the heat of the WAAM materials during fusing, causing the fresh concrete to crack or spall. These issues can be mitigated by the printing process or time lapse in the 3DP process, such as conducting the WAAM printing and waiting for the appropriate time prior to starting concrete printing.

The 3DP process is a complicated process in which many factors must be taken into account, such as the printing time slot, mixing material time, and time between layers. These are major factors that should be considered when printing concrete in large-scale sections. Therefore, time counts as a major influence on determining the excellent quality of printed concrete.

8. Conclusions and Future Trends

- This article is an analytical review of large-scale construction 3D printing technologies that are currently used, namely robotic arm and gantry 3D printing. The fundamental differences between these technologies are given, as well as data on the benefits and issues of using these advanced technologies in construction. Since the configuration of gantry printers has the ability to build buildings of almost unlimited sizes, it can be concluded that such printers are more suitable for large-scale printing. In order for the technology of large-scale construction 3D printing to be economically viable and applicable in practice, it is necessary to optimize the technology for printing with a material containing large aggregates.
- Generally, there is a growing interest worldwide in both academia and industry related to the field of 3D printing for large-scale construction applications. Nonetheless, there is still a significant lack of norms, code provisions and ad-hoc regulatory documents to provide specific guidance to apply this emerging technology in construction. Indeed, these documents would finally provide a common ground to spread the application of 3D printing in construction at a bigger scale rather than just for a few pioneering examples. The current trend is directed in this sense, and combined efforts from both researchers and industrial experts is needed to guarantee the development of ad-hoc guidelines related to the different printing types (i.e., in terms of the printing system and construction material). Future research will provide the basis for a new way of constructing more sustainable buildings and infrastructures by efficiently exploiting digital fabrication at a large scale.

Author Contributions: A.P.: Methodology, Section related to Robotic Arm in concrete application. P.S.: Conceptualization, Writing and revising, Original draft, Investigation in composite structure 3DP section. V.L.: Visualization, Investigation in WAAM section. M.D.: Supervision. All authors have read and agreed to the published version of the manuscript.

Funding: This research received no external funding. Laghi gratefully acknowledges the Italian L'Oreal-UNESCO program "For Women in Science" for the financial support.

Data Availability Statement: Data are available upon request.

Conflicts of Interest: The authors declare no conflict of interest.

References

1. Sandeep, B.; Kannan, T.; Chandradass, J.; Ganesan, M.; Rajan, A.J. Scope of 3D printing in manufacturing industries-A review. *Mater. Today Proc.* **2021**, *45*, 6941–6945. [[CrossRef](#)]
2. Fox, B.; Subic, A. An Industry 4.0 Approach to the 3D Printing of Composite Materials. *Engineering* **2019**, *5*, 621–623. [[CrossRef](#)]
3. Mallakpour, S.; Tabesh, F.; Hussain, C.M. 3D and 4D printing: From innovation to evolution. *Adv. Colloid Interface Sci.* **2021**, *294*, 102482. [[CrossRef](#)] [[PubMed](#)]
4. Sen, K.; Mehta, T.; Sansare, S.; Sharifi, L.; Ma, A.W.; Chaudhuri, B. Pharmaceutical applications of powder-based binder jet 3D printing process—A review. *Adv. Drug Deliv. Rev.* **2021**, *177*, 113943. [[CrossRef](#)] [[PubMed](#)]
5. Parulski, C.; Jennotte, O.; Lechanteur, A.; Evrard, B. Challenges of fused deposition modeling 3D printing in pharmaceutical applications: Where are we now? *Adv. Drug Deliv. Rev.* **2021**, *175*, 113810. [[CrossRef](#)]
6. Awad, A.; Fina, F.; Goyanes, A.; Gaisford, S.; Basit, A.W. 3D printing: Principles and pharmaceutical applications of selective laser sintering. *Int. J. Pharm.* **2020**, *586*, 119594. [[CrossRef](#)]

7. Mantihal, S.; Kobun, R.; Lee, B.-B. 3D food printing of as the new way of preparing food: A review. *Int. J. Gastron. Food Sci.* **2020**, *22*, 100260. [[CrossRef](#)]
8. Tomašević, I.; Putnik, P.; Valjak, F.; Pavlič, B.; Šojić, B.; Markovinović, A.B.; Kovačević, D.B. 3D printing as novel tool for fruit-based functional food production. *Curr. Opin. Food Sci.* **2021**, *41*, 138–145. [[CrossRef](#)]
9. Chakraborty, S.; Biswas, M.C. 3D printing technology of polymer-fiber composites in textile and fashion industry: A potential roadmap of concept to consumer. *Compos. Struct.* **2020**, *248*, 112562. [[CrossRef](#)]
10. Bozkurt, Y.; Karayel, E. 3D printing technology; methods, biomedical applications, future opportunities and trends. *J. Mater. Res. Technol.* **2021**, *14*, 1430–1450. [[CrossRef](#)]
11. Liu, C.; Xu, N.; Zong, Q.; Yu, J.; Zhang, P. Hydrogel prepared by 3D printing technology and its applications in the medical field. *Colloid Interface Sci. Commun.* **2021**, *44*, 100498. [[CrossRef](#)]
12. Mostafaei, A.; Elliott, A.M.; Barnes, J.E.; Li, F.; Tan, W.; Cramer, C.L.; Nandwana, P.; Chmielus, M. Binder jet 3D printing—Process parameters, materials, properties, modeling, and challenges. *Prog. Mater. Sci.* **2021**, *119*, 100707. [[CrossRef](#)]
13. Gadagi, B.; Lekurwale, R. A review on advances in 3D metal printing. *Mater. Today Proc.* **2020**, *45*, 277–283. [[CrossRef](#)]
14. Sivarupan, T.; Balasubramani, N.; Saxena, P.; Nagarajan, D.; El Mansori, M.; Saloniitis, K.; Jolly, M.; Dargusch, M.S. A review on the progress and challenges of binder jet 3D printing of sand moulds for advanced casting. *Addit. Manuf.* **2021**, *40*, 101889. [[CrossRef](#)]
15. Sama, S.R.; Wang, J.; Manogharan, G. Non-conventional mold design for metal casting using 3D sand-printing. *J. Manuf. Process.* **2018**, *34*, 765–775. [[CrossRef](#)]
16. Khoshnevis, B. Automated construction by contour crafting—Related robotics and information technologies. *Autom. Constr.* **2004**, *13*, 5–19. [[CrossRef](#)]
17. Shakor, P.; Nejadi, S.; Paul, G.; Malek, S. Review of Emerging Additive Manufacturing Technologies in 3D Printing of Cementitious Materials in the Construction Industry. *Front. Built Environ.* **2019**, *4*, 85. [[CrossRef](#)]
18. Attaran, M. The rise of 3-D printing: The advantages of additive manufacturing over traditional manufacturing. *Bus. Horiz.* **2017**, *60*, 677–688. [[CrossRef](#)]
19. Giannatsis, J.; Dedoussis, V. Additive fabrication technologies applied to medicine and health care: A review. *Int. J. Adv. Manuf. Technol.* **2007**, *40*, 116–127. [[CrossRef](#)]
20. Shakor, P.; Chu, S.H.; Puzatova, A.; Dini, E. Review of binder jetting 3D printing in the construction industry. *Prog. Addit. Manuf.* **2022**, *7*, 643–669. [[CrossRef](#)]
21. Duarte, G.; Brown, N.; Memari, A.; Duarte, J.P. Learning from historical structures under compression for concrete 3D printing construction. *J. Build. Eng.* **2021**, *43*, 103009. [[CrossRef](#)]
22. Perrot, A.; Pierre, A.; Nerella, V.; Wolfs, R.; Keita, E.; Nair, S.; Neithalath, N.; Roussel, N.; Mechtcherine, V. From analytical methods to numerical simulations: A process engineering toolbox for 3D concrete printing. *Cem. Concr. Compos.* **2021**, *122*, 104164. [[CrossRef](#)]
23. Bhattacharjee, S.; Basavaraj, A.S.; Rahul, A.; Santhanam, M.; Gettu, R.; Panda, B.; Schlangen, E.; Chen, Y.; Copuroglu, O.; Ma, G.; et al. Sustainable materials for 3D concrete printing. *Cem. Concr. Compos.* **2021**, *122*, 104156. [[CrossRef](#)]
24. Zhang, Y.; Zhang, Y.; She, W.; Yang, L.; Liu, G.; Yang, Y. Rheological and harden properties of the high-thixotropy 3D printing concrete. *Constr. Build. Mater.* **2019**, *201*, 278–285. [[CrossRef](#)]
25. Bai, G.; Wang, L.; Wang, F.; Ma, G. In-process reinforcing method: Dual 3D printing procedure for ultra-high performance concrete reinforced cementitious composites. *Mater. Lett.* **2021**, *304*, 130594. [[CrossRef](#)]
26. Markin, V.; Krause, M.; Otto, J.; Schröfl, C.; Mechtcherine, V. 3D-printing with foam concrete: From material design and testing to application and sustainability. *J. Build. Eng.* **2021**, *43*, 102870. [[CrossRef](#)]
27. Bai, G.; Wang, L.; Ma, G.; Sanjayan, J.; Bai, M. 3D printing eco-friendly concrete containing under-utilised and waste solids as aggregates. *Cem. Concr. Compos.* **2021**, *120*, 104037. [[CrossRef](#)]
28. Izadgoshasb, H.; Kandiri, A.; Shakor, P.; Laghi, V.; Gasparini, G. Predicting Compressive Strength of 3D Printed Mortar in Structural Members Using Machine Learning. *Appl. Sci.* **2021**, *11*, 10826. [[CrossRef](#)]
29. Schuldt, S.J.; Jagoda, J.A.; Hoisington, A.J.; Delorit, J.D. A systematic review and analysis of the viability of 3D-printed construction in remote environments. *Autom. Constr.* **2021**, *125*, 103642. [[CrossRef](#)]
30. Wangler, T.; Lloret, E.; Reiter, L.; Hack, N.; Gramazio, F.; Kohler, M.; Bernhard, M.; Dillenburger, B.; Buchli, J.; Roussel, N.; et al. Digital Concrete: Opportunities and Challenges. *RILEM Tech. Lett.* **2016**, *1*, 67–75. [[CrossRef](#)]
31. Yu, S.; Du, H.; Sanjayan, J. Aggregate-bed 3D concrete printing with cement paste binder. *Cem. Concr. Res.* **2020**, *136*, 106169. [[CrossRef](#)]
32. Ramakrishnan, S.; Muthukrishnan, S.; Sanjayan, J.; Pasupathy, K. Concrete 3D printing of lightweight elements using hollow-core extrusion of filaments. *Cem. Concr. Compos.* **2021**, *123*, 104220. [[CrossRef](#)]
33. Mohan, M.K.; Rahul, A.; De Schutter, G.; Van Tittelboom, K. Extrusion-based concrete 3D printing from a material perspective: A state-of-the-art review. *Cem. Concr. Compos.* **2020**, *115*, 103855. [[CrossRef](#)]
34. Geng, Z.; She, W.; Zuo, W.; Lyu, K.; Pan, H.; Zhang, Y.; Miao, C. Layer-interface properties in 3D printed concrete: Dual hierarchical structure and micromechanical characterization. *Cem. Concr. Res.* **2020**, *138*, 106220. [[CrossRef](#)]
35. Nerella, V.N.; Hempel, S.; Mechtcherine, V. Effects of layer-interface properties on mechanical performance of concrete elements produced by extrusion-based 3D-printing. *Constr. Build. Mater.* **2019**, *205*, 586–601. [[CrossRef](#)]

36. Mechtcherine, V.; Nerella, V.N.; Will, F.; Näther, M.; Otto, J.; Krause, M. Large-scale digital concrete construction—CONPrint3D concept for on-site, monolithic 3D-printing. *Autom. Constr.* **2019**, *107*, 102933. [CrossRef]
37. Wang, L.; Ma, G.; Liu, T.; Buswell, R.; Li, Z. Interlayer reinforcement of 3D printed concrete by the in-process deposition of U-nails. *Cem. Concr. Res.* **2021**, *148*, 106535. [CrossRef]
38. Marchment, T.; Sanjayan, J. Mesh reinforcing method for 3D Concrete Printing. *Autom. Constr.* **2019**, *109*, 102992. [CrossRef]
39. Baduge, S.K.; Navaratnam, S.; Abu-Zidan, Y.; McCormack, T.; Nguyen, K.; Mendis, P.; Zhang, G.; Aye, L. Improving performance of additive manufactured (3D printed) concrete: A review on material mix design, processing, interlayer bonding, and reinforcing methods. *Structures* **2021**, *29*, 1597–1609. [CrossRef]
40. Asprone, D.; Auricchio, F.; Menna, C.; Mercuri, V. 3D printing of reinforced concrete elements: Technology and design approach. *Constr. Build. Mater.* **2018**, *165*, 218–231. [CrossRef]
41. Bester, F.; van den Heever, M.; Kruger, J.; van Zijl, G. Reinforcing digitally fabricated concrete: A systems approach review. *Addit. Manuf.* **2020**, *37*, 101737. [CrossRef]
42. Lim, J.H.; Panda, B.; Pham, Q.-C. Improving flexural characteristics of 3D printed geopolymer composites with in-process steel cable reinforcement. *Constr. Build. Mater.* **2018**, *178*, 32–41. [CrossRef]
43. Pessoa, S.; Guimarães, A.S.; Lucas, S.S.; Simões, N. 3D printing in the construction industry—A systematic review of the thermal performance in buildings. *Renew. Sustain. Energy Rev.* **2021**, *141*, 110794. [CrossRef]
44. Apis-Cor.com. Apis-Cor 3D Concrete Printing. 2021. Available online: <https://www.apis-cor.com/> (accessed on 1 September 2021).
45. Chen, Y.; Zhang, Y.; Pang, B.; Liu, Z.; Liu, G. Extrusion-based 3D printing concrete with coarse aggregate: Printability and direction-dependent mechanical performance. *Constr. Build. Mater.* **2021**, *296*, 123624. [CrossRef]
46. Shakor, P.; Nejadi, S.; Paul, G. Investigation into the effect of delays between printed layers on the mechanical strength of inkjet 3DP mortar. *Manuf. Lett.* **2020**, *23*, 19–22. [CrossRef]
47. Xiao, J.; Ji, G.; Zhang, Y.; Ma, G.; Mechtcherine, V.; Pan, J.; Wang, L.; Ding, T.; Duan, Z.; Du, S. Large-scale 3D printing concrete technology: Current status and future opportunities. *Cem. Concr. Compos.* **2021**, *122*, 104115. [CrossRef]
48. Tian, Y.; Chen, C.; Xu, X.; Wang, J.; Hou, X.; Li, K.; Lu, X.; Shi, H.; Lee, E.-S.; Jiang, H.B. A Review of 3D Printing in Dentistry: Technologies, Affecting Factors, and Applications. *Scanning* **2021**, *2021*, 9950131. [CrossRef]
49. Alhumayani, H.; Gomaa, M.; Soebarto, V.; Jabi, W. Environmental assessment of large-scale 3D printing in construction: A comparative study between cob and concrete. *J. Clean. Prod.* **2020**, *270*, 122463. [CrossRef]
50. Gosselin, C.; Duballet, R.; Roux, P.; Gaudillière, N.; Dirrenberger, J.; Morel, P. Large-scale 3D printing of ultra-high performance concrete—A new processing route for architects and builders. *Mater. Des.* **2016**, *100*, 102–109. [CrossRef]
51. Werner, J.; Aburaira, M.; Raschendorfer, A.; Lackner, M. MeshSlicer: A 3D-Printing software for printing 3D-models with a 6-axis industrial robot. *Procedia CIRP* **2021**, *99*, 110–115. [CrossRef]
52. Siemasz, R.; Tomczuk, K.; Malecha, Z. 3D printed robotic arm with elements of artificial intelligence. *Procedia Comput. Sci.* **2020**, *176*, 3741–3750. [CrossRef]
53. Ali, M.H.; Kuralbay, Y. Design of a 6-DOF robot manipulator for 3D printed construction. *Mater. Today Proc.* **2022**, *49*, 1462–1468. [CrossRef]
54. Zhang, X.; Li, M.; Lim, J.H.; Weng, Y.; Tay, Y.W.D.; Pham, H.; Pham, Q.-C. Large-scale 3D printing by a team of mobile robots. *Autom. Constr.* **2018**, *95*, 98–106. [CrossRef]
55. Sakin, M.; Kiroglu, Y.C. 3D Printing of Buildings: Construction of the Sustainable Houses of the Future by BIM. *Energy Procedia* **2017**, *134*, 702–711. [CrossRef]
56. ApisCor. The World's Largest 3D Printed Building. 2021. Available online: <https://www.apis-cor.com/dubai-project> (accessed on 15 September 2021).
57. DeZeen. 2019. Available online: <https://www.dezeen.com/2019/12/22/apis-cor-worlds-largest-3d-printed-building-dubai/> (accessed on 10 May 2021).
58. ApisCor Beyond Earth. 2021. Available online: <https://www.apis-cor.com/space> (accessed on 12 September 2021).
59. Keating, S.J.; Leland, J.C.; Cai, L.; Oxman, N. Toward site-specific and self-sufficient robotic fabrication on architectural scales. *Sci. Robot.* **2017**, *2*, eaam8986. [CrossRef] [PubMed]
60. Apis Cor Gallery. 2021. Available online: <https://www.apis-cor.com/news?pgid=kqpv9ie0-22eeea15-6da4-42b6-aed5-13eb7ad9a5fa> (accessed on 10 September 2021).
61. About MX3D. 2021. Available online: <https://mx3d.com/company/about/> (accessed on 15 December 2021).
62. Le, T.T.; Austin, S.A.; Lim, S.; Buswell, R.A.; Gibb, A.G.F.; Thorpe, T. Mix design and fresh properties for high-performance printing concrete. *Mater. Struct.* **2012**, *45*, 1221–1232. [CrossRef]
63. Lim, S.; Buswell, R.; Le, T.; Austin, S.; Gibb, A.; Thorpe, T. Developments in construction-scale additive manufacturing processes. *Autom. Constr.* **2012**, *21*, 262–268. [CrossRef]
64. De Schutter, G.; Lesage, K.; Mechtcherine, V.; Nerella, V.N.; Habert, G.; Agusti-Juan, I. Vision of 3D printing with concrete—Technical, economic and environmental potentials. *Cem. Concr. Res.* **2018**, *112*, 25–36. [CrossRef]
65. Khoshnevis, B.; Hwang, D.; Yao, K.T.; Yeh, Z. Mega-scale fabrication by Contour Crafting. *Int. J. Ind. Syst. Eng.* **2006**, *1*, 301–320. [CrossRef]
66. Khoshnevis, B.; Bekey, G. Automated Construction Using Contour Crafting—Applications on Earth and Beyond. *Nist Spec. Publ. Sp.* **2003**, 489–494. [CrossRef]

67. Buswell, R.; Soar, R.C.; Gibb, A.G.F.; Thorpe, A. Freeform Construction: Mega-scale Rapid Manufacturing for construction. *Autom. Constr.* **2007**, *16*, 224–231. [[CrossRef](#)]
68. Lim, S.; Buswell, R.; Le, T.; Wackrow, R.; Austin, S.A.; Gibb, A.; Thorpe, T. Development of a Viable Concrete Printing Process. In Proceedings of the 28th International Symposium on Automation and Robotics in Construction (ISARC 2011), Seoul, Republic of Korea, 29 June–2 July 2011; pp. 665–670.
69. Spetsavia. 2015. Available online: <https://specavia.pro/> (accessed on 5 November 2021).
70. WASP. Crane WASP. 2021. Available online: <https://www.3dwasp.com/en/3d-printer-house-crane-wasp/> (accessed on 26 October 2021).
71. WASP. 3D Printed House TECLA. 2021. Available online: <https://www.3dwasp.com/en/3d-printed-house-tecla/> (accessed on 26 October 2021).
72. COBOD. The BOD2. 2021. Available online: <https://cobod.com/bod2/> (accessed on 21 December 2021).
73. COBOD. BOD2 Brochure. 2020. Available online: <https://cobod.com/wp-content/uploads/2020/10/BOD2-Brochure-2020.pdf> (accessed on 12 January 2022).
74. ICON. ICON, Vulcan. 2021. Available online: <https://www.iconbuild.com/vulcan> (accessed on 12 January 2022).
75. PERI. The Peri History. 2021. Available online: <https://www.peri.com/en/company/history.html> (accessed on 20 January 2022).
76. PERI. PERI Builds the First 3D-Printed Apartment Building in Germany. 2020. Available online: <https://www.peri.com/en/media/press-releases/peri-builds-the-first-3d-printed-apartment-building-in-germany.html> (accessed on 20 January 2022).
77. WinSun. WinSun, Company Profile. 2017. Available online: <http://www.winsun3d.com/En/About/> (accessed on 14 April 2021).
78. WinSun. WinSun, Product Center. 2017. Available online: <http://www.winsun3d.com/En/Product/prolist/id/1> (accessed on 14 April 2021).
79. WinSun. WinSun, Focus on Creating 3D Printing Water Conservancy Facilities. 2020. Available online: http://www.winsun3d.com/En/News/news_inner/id/568 (accessed on 13 April 2021).
80. WinSun. WinSun News. 2020. Available online: http://www.winsun3d.com/En/News/news_inner/id/564 (accessed on 13 April 2021).
81. Crafting Corporation. 2017. Available online: <https://www.contourcrafting.com/building-construction> (accessed on 13 April 2021).
82. PERI. Peri 3D Construction Printing. 2021. Available online: <https://www.peri.com/en/business-segments/3d-construction-printing.html> (accessed on 20 January 2022).
83. Ma, G.; Wang, L. A critical review of preparation design and workability measurement of concrete material for largescale 3D printing. *Front. Struct. Civ. Eng.* **2017**, *12*, 382–400. [[CrossRef](#)]
84. Papachristoforou, M.; Mitsopoulos, V.; Stefanidou, M. Evaluation of workability parameters in 3D printing concrete. *Procedia Struct. Integr.* **2018**, *10*, 155–162. [[CrossRef](#)]
85. Muthukrishnan, S.; Ramakrishnan, S.; Sanjayan, J. Technologies for improving buildability in 3D concrete printing. *Cem. Concr. Compos.* **2021**, *122*, 104144. [[CrossRef](#)]
86. Souza, M.T.; Ferreira, I.M.; de Moraes, E.G.; Senff, L.; de Oliveira, A.P.N. 3D printed concrete for large-scale buildings: An overview of rheology, printing parameters, chemical admixtures, reinforcements, and economic and environmental prospects. *J. Build. Eng.* **2020**, *32*, 101833. [[CrossRef](#)]
87. Yin, H.; Qu, M.; Zhang, H.; Lim, Y. 3D Printing and Buildings: A Technology Review and Future Outlook. *Technol. Des.* **2018**, *2*, 94–111. [[CrossRef](#)]
88. Tay, Y.W.D.; Qian, Y.; Tan, M.J. Printability region for 3D concrete printing using slump and slump flow test. *Compos. Part B Eng.* **2019**, *174*, 106968. [[CrossRef](#)]
89. Guo, X.; Yang, J.; Xiong, G. Influence of supplementary cementitious materials on rheological properties of 3D printed fly ash based geopolymer. *Cem. Concr. Compos.* **2020**, *114*, 103820. [[CrossRef](#)]
90. Albar, A.; Chougan, M.; Al Kheetan, M.J.; Swash, M.R.; Ghaffar, S.H. Effective extrusion-based 3D printing system design for cementitious-based materials. *Results Eng.* **2020**, *6*, 100135. [[CrossRef](#)]
91. Panda, B.; Tan, M.-J. Rheological behavior of high volume fly ash mixtures containing micro silica for digital construction application. *Mater. Lett.* **2018**, *237*, 348–351. [[CrossRef](#)]
92. Zhu, B.; Pan, J.; Zhou, Z.; Cai, J. Mechanical properties of engineered cementitious composites beams fabricated by extrusion-based 3D printing. *Eng. Struct.* **2021**, *238*, 112201. [[CrossRef](#)]
93. Panda, B.; Ruan, S.; Unluer, C.; Tan, M.J. Improving the 3D printability of high volume fly ash mixtures via the use of nano attapulgite clay. *Compos. Part B Eng.* **2018**, *165*, 75–83. [[CrossRef](#)]
94. Zhang, H.; Xiao, J. Plastic shrinkage and cracking of 3D printed mortar with recycled sand. *Constr. Build. Mater.* **2021**, *302*, 124405. [[CrossRef](#)]
95. Ding, T.; Xiao, J.; Qin, F.; Duan, Z. Mechanical behavior of 3D printed mortar with recycled sand at early ages. *Constr. Build. Mater.* **2020**, *248*, 118654. [[CrossRef](#)]
96. Ji, G.; Ding, T.; Xiao, J.; Du, S.; Li, J.; Duan, Z. A 3D Printed Ready-Mixed Concrete Power Distribution Substation: Materials and Construction Technology. *Materials* **2019**, *12*, 1540. [[CrossRef](#)]
97. Kazemian, A.; Yuan, X.; Cochran, E.; Khoshnevis, B. Cementitious materials for construction-scale 3D printing: Laboratory testing of fresh printing mixture. *Constr. Build. Mater.* **2017**, *145*, 639–647. [[CrossRef](#)]

98. Agustí-Juan, I.; Müller, F.; Hack, N.; Wangler, T.; Habert, G. Potential benefits of digital fabrication for complex structures: Environmental assessment of a robotically fabricated concrete wall. *J. Clean. Prod.* **2017**, *154*, 330–340. [CrossRef]
99. COBOD. COBOD, BOD2 Specifications. 2020. Available online: <https://cobod.com/wp-content/uploads/2020/09/BOD2-Specifications-1.pdf> (accessed on 16 October 2021).
100. Wang, L.; Ma, H.; Li, Z.; Ma, G.; Guan, J. Cementitious composites blending with high belite sulfoaluminate and medium-heat Portland cements for largescale 3D printing. *Addit. Manuf.* **2021**, *46*, 102189. [CrossRef]
101. Moelich, G.; Kruger, P.; Combrinck, R. The effect of restrained early age shrinkage on the interlayer bond and durability of 3D printed concrete. *J. Build. Eng.* **2021**, *43*, 102857. [CrossRef]
102. Haden, C.; Zeng, G.; Carter, F.; Ruhl, C.; Krick, B.; Harlow, D. Wire and arc additive manufactured steel: Tensile and wear properties. *Addit. Manuf.* **2017**, *16*, 115–123. [CrossRef]
103. Ji, L.; Lu, J.; Liu, C.; Jing, C.; Fan, H.; Ma, S. Microstructure and mechanical properties of 304L steel fabricated by arc additive manufacturing. *MATEC Web Conf.* **2017**, *128*, 03006. [CrossRef]
104. Williams, S.W.; Martina, F.; Addison, A.C.; Ding, J.; Pardal, G.; Colegrove, P. Wire + Arc Additive Manufacturing. *Mater. Sci. Technol.* **2016**, *32*, 641–647. [CrossRef]
105. Dinovitzer, M.; Chen, X.; Laliberte, J.; Huang, X.; Frei, H. Effect of wire and arc additive manufacturing (WAAM) process parameters on bead geometry and microstructure. *Addit. Manuf.* **2019**, *26*, 138–146. [CrossRef]
106. Kim, I.; Son, K.; Yang, Y.; Yaragada, P. Sensitivity analysis for process parameters in GMA welding processes using a factorial design method. *Int. J. Mach. Tools Manuf.* **2003**, *43*, 763–769. [CrossRef]
107. Xu, X.; Ding, J.; Ganguly, S.; Diao, C.; Williams, S. Oxide accumulation effects on wire + arc layer-by-layer additive manufacture process. *J. Mater. Process. Technol.* **2018**, *252*, 739–750. [CrossRef]
108. Ge, J.; Lin, J.; Chen, Y.; Lei, Y.; Fu, H. Characterization of wire arc additive manufacturing 2Cr13 part: Process stability, microstructural evolution, and tensile properties. *J. Alloys Compd.* **2018**, *748*, 911–921. [CrossRef]
109. Kyvelou, P.; Huang, C.; Gardner, L.; Buchanan, C. Structural Testing and Design of Wire Arc Additively Manufactured Square Hollow Sections. *J. Struct. Eng.* **2021**, *147*, 04021218. [CrossRef]
110. Gordon, J.; Haden, C.; Nied, H.; Vinci, R.; Harlow, D. Fatigue crack growth anisotropy, texture and residual stress in austenitic steel made by wire and arc additive manufacturing. *Mater. Sci. Eng. A* **2018**, *724*, 431–438. [CrossRef]
111. Kyvelou, P.; Slack, H.; Mountanou, D.D.; Wadee, M.A.; Britton, B.; Buchanan, C.; Gardner, L. Mechanical and microstructural testing of wire and arc additively manufactured sheet material. *Mater. Des.* **2020**, *192*, 108675. [CrossRef]
112. Laghi, V.; Palermo, M.; Tonelli, L.; Gasparini, G.; Girelli, V.A.; Ceschini, L.; Trombetti, T. Mechanical response of dot-by-dot wire-and-arc additively manufactured 304L stainless steel bars under tensile loading. *Constr. Build. Mater.* **2021**, *318*, 125925. [CrossRef]
113. Hejripour, F.; Binesh, F.; Hebel, M.; Aidun, D.K. Thermal modeling and characterization of wire arc additive manufactured duplex stainless steel. *J. Mater. Process. Technol.* **2019**, *272*, 58–71. [CrossRef]
114. Wu, B.; Pan, Z.; Chen, G.; Ding, D.; Yuan, L.; Cuiuri, D.; Li, H. Mitigation of thermal distortion in wire arc additively manufactured Ti6Al4V part using active interpass cooling. *Sci. Technol. Weld. Join.* **2019**, *24*, 484–494. [CrossRef]
115. Holt, C.; Edwards, L.; Keyte, L.; Moghaddam, F.; Townsend, B. Chapter 17—Construction 3D Printing. In *3D Concrete Printing Technology*; Sanjayan, J.G., Nazari, A., Nematollahi, B., Eds.; Butterworth-Heinemann: Oxford, UK, 2019; pp. 349–370.
116. Díazñez, I.; Gallegos, C.; la Fuente, E.B.; Martínez, I.; Valencia, C.; Sánchez, M.C.; Diaz, M.J.; Franco, J.M. 3D printing in situ gelification of κ -carrageenan solutions: Effect of printing variables on the rheological response. *Food Hydrocoll.* **2019**, *87*, 321–330. [CrossRef]
117. Perrot, A.; Rangeard, D.; Pierre, A. Structural built-up of cement-based materials used for 3D-printing extrusion techniques. *Mater. Struct.* **2015**, *49*, 1213–1220. [CrossRef]
118. Wolfs, R.J.M.; Bos, F.P.; Salet, T.A.M. Early age mechanical behaviour of 3D printed concrete: Numerical modelling and experimental testing. *Cem. Concr. Res.* **2018**, *106*, 103–116. [CrossRef]
119. Roussel, N. A thixotropy model for fresh fluid concretes: Theory, validation and applications. *Cem. Concr. Res.* **2006**, *36*, 1797–1806. [CrossRef]
120. Weng, Y.; Li, M.; Tan, M.J.; Qian, S. Design 3D printing cementitious materials via Fuller Thompson theory and Marson-Percy model. *Constr. Build. Mater.* **2018**, *163*, 600–610. [CrossRef]
121. Nerella, V.N.; Krause, M.; Mechtcherine, V. Practice-oriented buildability criteria for developing 3D-printable concretes in the context of digital construction. *Civ. Eng.* **2018**, preprint. [CrossRef]
122. Bos, F.; Wolfs, R.; Ahmed, Z.; Salet, T. Additive manufacturing of concrete in construction: Potentials and challenges of 3D concrete printing. *Virtual Phys. Prototyp.* **2016**, *11*, 209–225. [CrossRef]
123. COBOD. COBOD, Gantry Versus Robotic Arm System. 2018. Available online: <https://cobod.com/gantry-versus-robotic-arm-systems/> (accessed on 16 October 2021).
124. Dörfler, K.; Dielemans, G.; Lachmayer, L.; Recker, T.; Raatz, A.; Lowke, D.; Gerke, M. Additive Manufacturing using mobile robots: Opportunities and challenges for building construction. *Cem. Concr. Res.* **2022**, *158*, 106772. [CrossRef]
125. IAAC. Minibuilders. Available online: <https://iaac.net/project/minibuilders/> (accessed on 1 August 2022).
126. Baubot. The New Standard in Construction Robotics. Available online: <https://www.baubot.com/> (accessed on 1 August 2022).
127. CyBe. 3D Concrete Printers. Available online: <https://cybe.eu/3d-concrete-printing/printers/> (accessed on 16 July 2022).

128. Keating, S. Digital Construction Platform. 2016. Available online: <https://www.media.mit.edu/projects/digital-construction-platform-v-2/overview/> (accessed on 16 June 2022).
129. Twente Additive Manufacturing. Innovative and Sustainable Building Construction. 2022. Available online: <https://www.twente-am.com/> (accessed on 30 August 2022).
130. Khoshnevis, B.; Hwang, D. Contour crafting. In *Rapid Prototyping*; Springer: New York, NY, USA, 2006; pp. 221–251.
131. Huang, S.; Xu, W.; Li, Y. The impacts of fabrication systems on 3D concrete printing building forms. *Front. Arch. Res.* **2022**, *11*, 653–669. [[CrossRef](#)]
132. SQ4D. SQ4D Printer. 2022. Available online: <https://www.sq4d.com/> (accessed on 30 August 2022).
133. Cunningham, C.; Flynn, J.; Shokrani, A.; Dhokia, V.; Newman, S. Invited review article: Strategies and processes for high quality wire arc additive manufacturing. *Addit. Manuf.* **2018**, *22*, 672–686. [[CrossRef](#)]
134. Wu, B.; Pan, Z.; Ding, D.; Cuiuri, D.; Li, H.; Xu, J.; Norrish, J. A review of the wire arc additive manufacturing of metals: Properties, defects and quality improvement. *J. Manuf. Process.* **2018**, *35*, 127–139. [[CrossRef](#)]
135. Jafari, D.; Vaneker, T.H.; Gibson, I. Wire and arc additive manufacturing: Opportunities and challenges to control the quality and accuracy of manufactured parts. *Mater. Des.* **2021**, *202*, 109471. [[CrossRef](#)]
136. Nikam, P.P.; Arun, D.; Ramkumar, K.D.; Sivashanmugam, N. Microstructure characterization and tensile properties of CMT-based wire plus arc additive manufacturing ER2594. *Mater. Charact.* **2020**, *169*, 110671. [[CrossRef](#)]
137. Wang, C.; Liu, T.; Zhu, P.; Lu, Y.; Shoji, T. Study on microstructure and tensile properties of 316L stainless steel fabricated by CMT wire and arc additive manufacturing. *Mater. Sci. Eng. A* **2020**, *796*, 140006. [[CrossRef](#)]
138. Song, Y.; Yan, Y.; Zhang, R.; Xu, D.; Wang, F. Manufacture of the die of an automobile deck part based on rapid prototyping and rapid tooling technology. *J. Mater. Process. Technol.* **2002**, *120*, 237–242. [[CrossRef](#)]
139. Salet, T.A.M.; Ahmed, Z.Y.; Bos, F.P.; Laagland, H.L.M. Design of a 3D printed concrete bridge by testing. *Virtual Phys. Prototyp.* **2018**, *13*, 222–236. [[CrossRef](#)]
140. Mechtcherine, V. 3D-printed steel reinforcement for digital concrete construction—Manufacture, mechanical properties and bond behaviour. *Constr. Build. Mater.* **2018**, *179*, 125–137. [[CrossRef](#)]
141. Dörrie, R.; Laghi, V.; Arrè, L.; Kienbaum, G.; Babovic, N.; Hack, N.; Kloft, H. Combined Additive Manufacturing Techniques for Adaptive Coastline Protection Structures. *Buildings* **2022**, *12*, 1806. [[CrossRef](#)]
142. Al-Qutaifi, S.; Nazari, A.; Bagheri, A. Mechanical properties of layered geopolymer structures applicable in concrete 3D-printing. *Constr. Build. Mater.* **2018**, *176*, 690–699. [[CrossRef](#)]
143. Shakor, P.; Nejadi, S. 3D Printed Concrete Evaluations by Using Different Concrete Mix Designs. In Proceedings of the Recent trends in Engineering and Technology, Bangkok, Thailand, 3–4 May 2017.
144. Marchment, T.; Xia, M.; Dodd, E.; Sanjayan, J.; Nematollahi, B. Effect of Delay Time on the Mechanical Properties of Extrusion-Based 3D Printed Concrete. In Proceedings of the 34th International Symposium on Automation and Robotics in Construction (ISARC), Taipei, Taiwan, 28 June–1 July 2017; pp. 240–245.
145. Sanjayan, J.G.; Nematollahi, B.; Xia, M.; Marchment, T. Effect of surface moisture on inter-layer strength of 3D printed concrete. *Constr. Build. Mater.* **2018**, *172*, 468–475. [[CrossRef](#)]
146. Panda, B.; Paul, S.C.; Hui, L.J.; Tay, Y.W.D.; Tan, M.J. Additive manufacturing of geopolymer for sustainable built environment. *J. Clean. Prod.* **2017**, *167*, 281–288. [[CrossRef](#)]
147. Panda, B.; Paul, S.C.; Tan, M.J. Anisotropic mechanical performance of 3D printed fiber reinforced sustainable construction material. *Mater. Lett.* **2017**, *209*, 146–149. [[CrossRef](#)]
148. Ma, G.; Zhang, J.; Wang, L.; Li, Z.; Sun, J. Mechanical characterization of 3D printed anisotropic cementitious material by the electromechanical transducer. *Smart Mater. Struct.* **2018**, *27*, 075036. [[CrossRef](#)]
149. Paul, S.C.; Tay, Y.W.D.; Panda, B.; Tan, M.J. Fresh and hardened properties of 3D printable cementitious materials for building and construction. *Arch. Civ. Mech. Eng.* **2018**, *18*, 311–319. [[CrossRef](#)]
150. Shakor, P.; Nejadi, S.; Paul, G.; Gowripalan, N. Effects of Different Orientation Angle, Size, Surface Roughness, and Heat Curing on Mechanical Behavior of 3D Printed Cement Mortar With/Without Glass Fiber in Powder-Based 3DP. *3D Print. Addit. Manuf.* **2021**. [[CrossRef](#)]
151. Laghi, V.; Palermo, M.; Tonelli, L.; Gasparini, G.; Ceschini, L.; Trombetti, T. Tensile properties and microstructural features of 304L austenitic stainless steel produced by wire-and-arc additive manufacturing. *Int. J. Adv. Manuf. Technol.* **2020**, *106*, 3693–3705. [[CrossRef](#)]
152. Wu, W.; Xue, J.; Wang, L.; Zhang, Z.; Hu, Y.; Dong, C. Forming Process, Microstructure, and Mechanical Properties of Thin-Walled 316L Stainless Steel Using Speed-Cold-Welding Additive Manufacturing. *Metals* **2019**, *9*, 109. [[CrossRef](#)]
153. Soltan, D.G.; Li, V.C. A self-reinforced cementitious composite for building-scale 3D printing. *Cem. Concr. Compos.* **2018**, *90*, 1–13. [[CrossRef](#)]