



**ERBIL POLYTECHNIC  
UNIVERSITY**



**ISHIK UNIVERSITY**

**IEC2016**

**2<sup>nd</sup> International Engineering Conference  
On Developments in Civil & Computer Engineering Application**

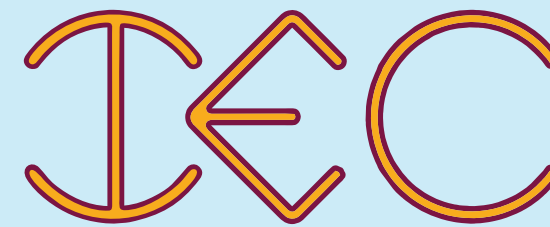

**International Engineering Conference  
Ishik University**



© ISHIK University 2016

ISSN 2409-6997



**ERBIL POLYTECHNIC UNIVERSITY**

Kerkuk Road, Erbil KRG - IRAQ  
[www.epu.edu.krd](http://www.epu.edu.krd)



**ISHIK UNIVERSITY**

100m Road, opposite  
Fakhir Mergasory School, Erbil KRG - IRAQ  
0750 835 75 25 - 0750 705 02 11  
[info@ishik.edu.iq](mailto:info@ishik.edu.iq) [www.ishik.edu.iq](http://www.ishik.edu.iq)

Proceedings of the  
**2nd International Engineering Conference  
On Developments in Civil & Computer  
Engineering Applications  
IEC2016**

**2nd International Engineering Conference On Developments in  
Civil & Computer Engineering Applications**

Feb 20-21, 2016



ISSN 2409 – 6997 (Print)



## **Preface**

The 2nd International Engineering Conference on Developments in Civil and Computer Engineering Applications (IEC2016) is held for the period from 21 to 22 February 2016. This year the conference is organized jointly by ISHIK University and Erbil Polytechnic University. ISHIK University is always keen to establish connection with other educational institutions whether nationally or internationally.

The conference tracks included the following research topics: Structural Materials, Structural Engineering, Earthquake engineering, Geotechnical Engineering, Environmental Engineering, Fluid Mechanics, Transportation Engineering, Restoration and Rehabilitation of Historical Buildings, Construction Management, Sustainability of Concrete and Steel Structures, Artificial & Computational Intelligence, Control and Robotics, Communications, Networking & Protocols, Parallel & Distributed Processing, Signal and Multimedia Processing, Biomedical and Health Informatics, Mobile and Smartphone Applications, Software Engineering and Applications, Green Computing for Sustainable Energy and Cloud Computing.

The program committee (the reviewers) comprised of more than 24 members. All of which are Ph.D. holders and professional in certain engineering area that is relevant to one or more of the conference tracks mentioned above. The same international conference standards that were adopted in the previous IEC2014 were adopted in IEC2016. All submissions are peer-reviewed by at least three program committee members to insure that submissions conform to certain quality measures. The quality measures included several criteria such as writing skill, quality of the presentation and contents, fitness of the title, significance for theory or practice, originality and innovation level.

This year, more than 40 manuscripts were received targeting both the civil and computer engineering fields. Of those submissions eventually about 68% were accepted using a thorough reviewing process. The authors of manuscripts exceeding certain plagiarism percentage were notified to adjust their manuscripts otherwise these submissions were rejected with notification to the authors. Each submitted manuscript was double-checked for plagiarism and template format and then reviewed by at least three members. Some reviewed submissions were marked as “revise” and authors of those submissions were given the chance to revise their manuscripts considering the reviewers professional feedback. These revised manuscripts were resubmitted for one final review process to either accept or reject. Some other manuscripts were rejected or withdrawn because they were not within the conference scope.

**Asst. Prof. Dr. Ali Kattan**  
Editor-in-Chief





# IEC2016 Organizing Committee



Honorable Chair  
**Prof. Dr. Ahmat Oztas**  
President of Ishik University



Honorable Chair  
**Dr. Kawa Sherwani**  
President of Erbil Polytechnic University



**Dr. Duran Kala**  
Conference Chair  
Dean Faculty of Engineering & Science  
Ishik University



**Mr. Samih Aydin**  
Head of IT Department  
Ishik University



**Mr. Safwan Mawlud**  
Head of Computer Eng. Department  
Ishik University



**Mr. Berham Haydar**  
Head of Civil Eng Department  
Ishik University



**Dr. Adnan Shihab**  
Director of Academic & International Relations  
Erbil Polytechnic University



**Dr. Basil Younus**  
Head of Civil Engineering Department  
Eng. Technical College



**Dr. Bzar Khidr Hussain**  
Head of ISE Department, Eng. Technical College  
Erbil Polytechnic University



**Dr. Khalel Hassan**  
Head of High way Department, Technology Institute  
Erbil Polytechnic University



**IEC2016**  
**Organizing Committee**  
**Technical Support Team**

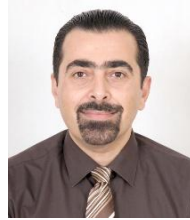

**Asst. Prof. Dr. Ali Kattan**  
Editor-in-Chief  
IT Department  
Ishik University



**Mr. Muhammed Nisham Anwer**  
Head of Technical Support  
IT Department  
Ishik University



**Ms. Bahrin Ali Hassan**  
Member of Technical Support  
IT Department  
Ishik University



**Ms. Chra Ismael Doghramachy**  
Member of Technical Support  
Computer Eng. Department  
Ishik University



**Mr. Kadir Elci**  
Member of Technical Support  
IT Department  
Ishik University



# IEC2016

## Program Committee



**Prof. Dr. Bayan Salim**  
Co-Chair  
Civil Eng. Department, Ishik University  
Erbil, Iraq



**Prof. Dr. Bashir Thabit Mohammed**  
Department of Dam and Water Resources  
Engineering  
Engineering College University of Salahaddin  
Erbil, Iraq



**Prof. Dr. Rosni Abdullah**  
Department of Computer Sciences, National  
Advance IPv6 Centre  
University Sains Malaysia  
Penang, Malaysia



**Prof. Dr. Mereen Hassan Fahmi Rasheed  
Akrawi**  
Technical Engineering College  
Erbil Polytechnic University  
Erbil, Iraq



**Assoc. Prof. Dr. Omar Amer Abouabdalla**  
Chief Technology Officer (CTO) of NetWeave Sdn  
Bhd Head of Training - IPv6 Forum Malaysia Kuala  
Lumpur, Malaysia



**Assoc. Prof. Dr. Wan Tat Chee**  
School of Computer Sciences  
Universiti Sains Malaysia  
Penang, Malaysia



**Asst. Prof. Dr. Ali Kattan**  
Editor-in-Chief  
IT Department, Ishik University  
Erbil, Iraq



**Assoc. Prof. Dr. Thamir M. Ahmad**  
Co-Chair  
Civil Eng. Department, Ishik University  
Erbil, Iraq



# IEC2016 Program Committee



**Asst. Prof. Dr. AbdulKareem Darweesh Mahmood**  
Department of Civil Engineering  
Engineering College University of Salahaddin  
Erbil, Iraq



**Asst. Prof. Dr. Mohammed Azmi Al-Betar**  
Department of Information Technology  
Al-Huson University College  
Al-Balqa Applied University  
Irbid, Jordan



**Asst. Prof. Dr. Tarik Ahmed Rashid**  
Director of Information and Communication  
Center, Salahadin University-Erbil, Iraq



**Dr, Botan Majeed Ahmad AL-Hadad**  
Dean, Erbil Technology Institute  
Erbil Polytechnic University  
Erbil, Iraq



**Dr. Nasuha Lee Abdullah**  
School of Computer Sciences  
Universiti Sains Malaysia  
Penang, Malaysia



**Dr. Reem Alrawi**  
Department of Dam and Water Resources  
Engineering Engineering College University of  
Salahaddin Erbil, Iraq



**Dr. Cumhur Aksu**  
Department of Information Technology  
Ishik University  
Erbil, Iraq



**Dr. Abdulfattah Ahmad Amin Fattah Al-Najjar**  
Head, Surveying Department  
Erbil Technical Institute, Erbil Polytechnic  
University Erbil, Iraq





# IEC2016 Program Committee



**Dr. Ganjeena J. Madhat Khoshnaw**  
Erbil Technical institute  
Erbil Polytechnic University  
Erbil, Iraq



**Dr. Samaher Hussein Ali Al-Janabi**  
Department of Information Networks  
Faculty of Information Technology  
University of Babylon  
Babylon, Iraq



**Dr. Abdulkareem Sh. Mahdi Al-Obaidi**  
Senior Lecturer, School of Engineering  
Taylor's University Kuala Lumpur, Malaysia



**Dr. Iyd Eqqab Maree**  
Erbil Technical Engineering College  
Erbil Polytechnic University  
Erbil, Iraq



**Dr. Mohammed Ali Ihasn**  
Department of Civil Engineering University of  
Salahaddin-Iraq



**Dr. Khalel Hassan**  
Head of High way Department, Technology  
Institute  
Erbil Polytechnic University



**Dr. Nageb Toma Bato Rassam**  
Co-Chair  
Vice President For Scientific Affairs  
Erbil Polytechnic University



**Dr. Basil Younus**  
Head of Civil Engineering Department  
Eng. Technical College



# IEC2016

## Keynote Speaker

**Dr. Amanj Saeed,**  
MB.CH.B, MD, MSc, PhD  
Advisor to the Minister of Higher  
Education and Scientific Research of KRG



He services as chairman of Quality Assurance and National University Ranking Boards. He is actively involved in Higher Education initiatives such as Human Capacity Development scholarship program, research promotion, curriculum development, medical education and internationalization of higher education. He has previously served as the higher education advisor to the office of KRG prime minister and has worked on Higher Education Reform projects, Medical Education, and Human Capacity Development. He was also lecturer at the University of Sulaimani, School of Medicine, department of microbiology and infectious diseases.

He holds PhD in Clinical Microbiology and Infectious Diseases and MSc in Clinical Microbiology from the University of Nottingham, UK. He obtained his bachelor's degree in Medicine and Surgery, and Bachelors Degree in law from the University of Sulaimani.

Dr. Saeed is focused in his research on developing a model to study liver fibrosis in response to Hepatitis C virus infection.



# IEC2016

## Keynote Speaker

**Professor Dr. Ibrahim Hamarash**  
Vice President for Scientific Affairs  
and Postgraduate Studies  
Salahaddin University-Erbil



Ibrahim Hamarash is Professor of Electrical Engineering at Salahaddin University-Erbil. Dr.Ibrahim has been teaching classes on the Control Systems since 1993. He is the founder of the Software Engineering Department (2001), He is the co-founder of the Mobile Education Centre for Regenerative Energy and Automation (MECREA) with Karlsruhe University for Applied Science, Germany (2011), He is also the co-founder of Erbil Centre for Sustainable Development with scientists from five other international universities (2012). He studies at the universities of Salahaddin (Kurdistan), Mosul (Iraq), Technology (Iraq), Monash (Australia), UCSD (USA). Prof.

Hamarash has published over 35 articles on topics of Control Systems and Information Technology in peer-reviewed journals. He is the author of Computer Dictionary (English-Kurdish) and Computers (Text books for year 7 & 8 high school students in Kurdistan Region). Professor Ibrahim's honors and Grants include the award for Endeavour Postdoctoral Award (2007,Australia), NSF Grant(2004,USA), UNESCO Research Grant (2001), Endeavour Executive Grant (2015 Australia). He is a member of IEEE and currently is the vice president for scientific affairs and postgraduate studies at Salahaddin University-Erbil.



# IEC2016

## Keynote Speaker

**Asso. Prof. Dr. Mehmet Cemal Genes**  
Civil Engineering Department, Engineering Faculty,  
Zirve University, Gaziantep, Turkey



Dr. Cemal Genes borned in 1972, in a small village of Hatay. He is an Associate professor in the Department of Civil Engineering of Zirve University, Gaziantep since 2012. His academic carrier started 20 years ago in the Department of Civil Engineering of Mustafa Kemal University. After his completion of master and Ph.D. studies on nonlinear analysis of frames and Soil-Structure interaction problems at Cukurova University in 2011, he studied as visiting assistant professor on Computational Fluid Dynamics and Simulation by using High Performance Programming at Mechanical and Material Science Engineering Department of Rice University, Houston. He is an expert on Building Health Monitoring. He instrumented several buildings with permanent and temporary accelerometers for health monitoring of RC and Masonry buildings located in Antakya. He organized two workshops on Seismic Risk Assessment and Mitigation in the Antakya-Maras Region on the basis of Microzonation, Vulnerability and Preparedness Studies, in 2010 and 2012, and also he organized the 2nd Turkish Conference on Earthquake Engineering and Seismology in 2013. Dr. Genes has an outstanding recored of more than forty scientific papers in Indexed journals and conferences.





# Table of Contents

Sustainable Wastewater Treatment in Constructed Wetlands..... Yaseen Ahmed Hamaamin	1
Sustainable Concrete by Using Fly ash as a Cement Replacement..... Daban A. Muhedin, Ahmed J. Hama Rash, Madih I. Hamakareem.	9
Prediction of Time-Dependent Deflection of High Strength Concrete Panels..... Bayan S. Al Numan, Faris R. Ahmed.	16
Comparison of Mat Foundation Design Using Rigid Method and SAFE Program..... Muhammad Arf Muhammad	25
Assessment of Vertical Pile Capacity in Soil with Weak Layers and Cavities..... Ahmed A. Al-Obaidi, Pinar N. Mahmood, Ansam A. Al-Karawi	35
Use of Plastic Waste in Gypseous Soil Reinforcement..... Omer Muhie Eldeen Taha, Junaid Kameran Ahmed, Barham Haidar Ali, Mohammed Taraq	44
The Effect Of Fiber Orientation And Number Of Layer On The Natural Frequency Of Composite Laminated Plate..... Junaid Kameran Ahmed, Omer M.E. Taha, Barham Haider, Mohammed Tareq	53
Sustainability In Construction Projects: Part 1 Elements..... Bayan S. Al-Nu'man, Thamir M. Ahmed	61
Sustainability In Construction Projects: Part 2 (Case Studies)..... Bayan S. Al-Nu'man, Thamir M. Ahmed	69
Effects of Gate Geometries on Top Pressure Coefficient of Dam Tunnel Gate..... Thamir M. Ahmed, Awat Omar Anwar	85
Environmental Pollution and Impacts of Dust Storms on the Traffic Safety..... Amera I. Hussain, Eman L. Salman	91
Applications Of Geographic Information Systems In Construction Management..... Cemil Akdeniz	97
Effect Of Increasing Columns Concrete Strength On Columns Reinforcement Ratio In High Rise Buildings..... Bayan S. Al-Nu'man	104
Erbil Citadel Landscape Assessment In Order To Regional Best Practices..... Siba Nazem Kady, Mahmood Hussein	112
Experimental Investigation on Pressure Coefficients along Bottom Surface of Dam Tunnel Gate With aid of Mapping Presentations ..... Thamir M. Ahmed	120



Can Image Processing Technique Be Used as a Non-destructive Test In Predicting Concrete Compressive Strength.....	127
Khalid B. Najim	
Challenges of Network Management in Cloud Computing.....	136
Shivan Fazil Sabr	
Comparing Routing Protocols in Opportunistic Networks.....	145
Shivan Fazil Sabr	
Performance Evaluation of MIMO Receivers in Two-way Decode and Forward Relaying.....	154
Mete Yıldırım, Cumhuri Aksu, Selcuk Cankurt	
Mechanical Performance of Concrete Reinforced with Steel Fibres Extracted from Post-Consumer Tyres.....	162
Khaleel H. Younis	
A Two Dimensional GIS Model for Highway Alignment Corridor Search.....	170
Botan M AL-Hadad, Mohammed D Allaf, Glpa A Mahmood, Wrya H Nadir	
Evaluation of Using Total Station Instead of Level in Determining Elevations.....	178
Soran Polus Khorani, Kubad Zeki Henari	
Validation of 2d-Deformable Numerical Model Used in Behaviour's Simulation of Laminated Glass Panels Subjected to Bending Loads and Effects of Layers Thickness on the Maximum Principle Stress.....	186
Rasha AL-Kabbanie, Mohammed Fathi Ganameh, Mohallab AL-Dawood	
5G Technology: A review.....	194
Bayar Shahab,Rebaz Salih	
Online Social Networks in academia: A Review of Applications and Issues.....	203
Ibrahim AlShourbaji, Samaher Al-Janabi, Wan Khairuzzaman, Wan Ismail, Sophia Alim, Mohammed Abdelhag	
Residential Building Development Process In Kurdistan Region Government.....	213
Haval Mohammed Salih	
An Analysis of Occupational Accidents in the Demolition Works.....	223
Hüseyin Ertaş, Ali Sayıl Erdoğan	
Advanced Models for Soil-Structure Interaction Problems.....	235
Genes, M.C.	
Design and Implementation of Resizable Cache Memory using FPGA.....	246
Safaa S. Omran, Ibrahim A. Amory	



## **Sustainable Wastewater Treatment in Constructed Wetlands**

Yaseen Ahmed Hamaamin

*Civil Engineering Department, Faculty of Engineering, University of Sulaimani, KRG-Iraq  
yassen.amin@univsul.edu.iq*

### **ABSTRACT**

Waterborne diseases and contaminations originate from either/both point sources (e.g., sewage discharge) or nonpoint sources (e.g., agricultural practices) of pollutions have resulted in human infection and death, social and economic consequences. Using conventional water disinfectant chemicals such as chlorine results in generating unwanted carcinogen (cause cancer) by-products. Therefore the use of sustainable wastewater treatment disinfection is necessary. Wetlands have been used as an economic and environmental-friendly method of wastewater treatment without using any chemical agents. Wetlands can improve the quality of water using intricate combination of physical, chemical and biological reactions through sedimentation, filtration, nutrient transformation, microorganisms stimulating and plants uptake processes. Constructed wetlands fall under two hydrological groups, surface flow and subsurface flow wetlands. Surface flow wetlands use shallow depth of water for the treatment which sunlight, microorganisms and plants are involved. The subsurface flow wetlands treat water in subsurface permeable media through physical, chemical and biological reactions, that plants root zone plays an important role. Wetlands can recover and improve water quality safeguarding the build-up of harmful chemicals in the environment. This paper illustrates and discusses different types of constructed wetlands as natural sustainable cost-effective wastewater treatment option without any harmful chemical by-products. The design aspects and pollution removal mechanisms in wetlands have been discussed as well.

**Keywords:** Constructed Wetlands, Sustainable Management, Wastewater Treatment.

### **1. INTRODUCTION**

Wastewater is the water that has been used for human activities and requirements which usually contains various pollutants and pathogens, depending on its usage [1]. Domestic wastewater, agricultural drainage, industrial sewage and stormwater runoff have great negative impact on receiving water ecosystems such as rivers, lakes and estuaries. This is mainly because untreated wastewater usually contains contaminants, nutrients (nitrogen and phosphorus) that can deplete the amount of dissolved oxygen and stimulate the growth of aquatic plants (known as algae boom), which called eutrophication problem in receiving waters [2, 3]. However reducing contamination from wastewater is essential, also the treatment processes must have minimum impact on the environment, including, but not limited to, preserving the aquatic ecosystem, reducing energy usage, minimizing greenhouse gas emissions, and finally minimizing unwanted harmful by-products [4].

Over the past few decades, several cases of animal manure and fecal bacteria related diseases have been reported. In January 1987, manure runoff caused 1300 infections in Georgia. In 1993, due to manure and human excrement 87 people died of 400000 total infection cases in Milwaukee, Wisconsin. In 2000, *E. coli* entered water supply system as result from farms runoff in Walkerton, Canada and resulted in death of 6 people out of 2300 infection cases [5, 6].

While most abundant water disinfection methods are done by using disinfectant chemicals such as chlorine, however, using chemical disinfectants are costly and produce unwanted by-products such as trihalomethanes, which are carcinogenic [7]. Thus, lately directions are towards using more environmentally sustainable, socially accepted, and cost-effective wastewater treatments methods, and here may wetlands be the promise systems [2, 8].

Wetlands are natural filters, helping to improve the quality of wastewater from point and non-point pollutant sources from urban and agricultural lands. Constructed wetlands are engineered systems mimic natural decontamination processes which plants, soils and associated microorganisms are involved [9]. Therefore in the recent years, constructed wetlands have been used as economical, biodegradable and effective way for the treatment of different types of wastewater at different stages, primary, secondary and tertiary levels of treatment [10].

This paper reviews wetlands importance as modern sustainable environmental-friendly technique for point and nonpoint pollution sources removal and wastewater treatment.

## **2. CONSTRUCTED WETLANDS**

Constructed wetland is considered a complex bioreactor, simulating natural wetland systems in which a number of physical, chemical, and biological processes occur. In the system microbial communities, emergent plants, soil, and sedimentation take place. As nitrogen (N) and phosphorus (P) concentrations are the cause of adverse effects in receiving water systems. As illustrated in Table 1, constructed wetland relatively gives superior removal results in biochemical oxygen demand (BOD), suspended solids (SS), total nitrogen (TN) and total phosphorus (TP) compared with the conventional wastewater treatment plant (which uses wastewater treatment conventional units). Moreover the additional benefits of the removal of bacteria (*E.coli*) and heavy metal are turned out in the wetland [11].

### **2.1. TYPES OF CONSTRUCTED WETLANDS**

According to hydrology or flow direction in the system, constructed wetlands can be divided in two types, surface flow and subsurface flow wetland systems. The selection of the wetland type depends on the characteristic of wastewater (pollutants type and concentration), the available land and the required treatment level.

TABLE 1.

Removal comparison of a conventional treatment plant with a constructed wetland for sewage treatment with flowrate of 100 m<sup>3</sup>/day [11]

Treatment system type	Economic Considerations			Removal Efficiency %				Remarks
	Const- ruction cost(\$)	Management cost (\$/year)	size (m <sup>3</sup> )	BOD	SS	TN	TP	
Constructed Wetland	220 000	300	800	80-90	80-90	45	55	heavy metals and <i>E.coli</i> removal
Conventional treatment plant	300 000	2000	99	70-80	20-30	<20	---	-----

### 2.1.1. SURFACE FLOW WETLAND SYSTEMS

In surface flow wetlands, the depth of surface water flow systems varies from 20 to 60 centimeters, and the wetland is heavily vegetated. Surface flow wetlands fall into two groups according to the vegetated plant type. Figure 1, shows surface flow wetland with floating plants (duckweed), while Figure 2 shows surface wetland with emergent plants (macrophytes). The shallow depth of water in the system allows high intensity of sunlight penetration to the wetland bottom, which helps in an active photosynthesis and plants growth. The surface flow wetland systems offer low construction cost, but they generally have a lower contaminant removal efficiency compared with sub-surface flow systems. This type of wetlands is useful for wastewater treatment plants effluent treatment. Wetlands with floating plants have higher percentage of nutrient removal compared to wetlands with no free-floating plants, through frequent harvesting of the plants [12].

### 2.1.2. SUBSURFACE FLOW WETLAND SYSTEMS

This system consists of a ditch or a bed, mostly bounded by an impervious layer to protect groundwater from pollution. Figure 3 shows horizontal subsurface flow constructed wetland and Figure 4 shows a vertical flow subsurface constructed wetland. The filter media of subsurface wetland system along with the physical removal of impurities assist the growth of emergent plants in which help and improve purification process. The media is typically composed of mixture of different soils including sand, crushed gravel of 10–15mm diameter, in various combinations according to the required removal [13].

## 3. MECHANISM OF CONTAMINANTS REMOVAL IN CONSTRUCTED WETLANDS

Nitrogen as an abundant element on earth exists in different organic and inorganic forms; it represents major water pollutant that has a complex biogeochemical cycle



with several biotic and abiotic transformations. Biotic transformation mediated by microorganisms while abiotic transformations resulted from chemical reactions. Wastewater treatments in constructed wetlands are multiple including different nitrogen reactions such as ammonification (decomposition of nitrogenous compounds to generate ammonia), ammonia volatilization, nitrification (biological oxidation of ammonia), denitrification (microbial reducing nitrate to gaseous nitrogen), nitrogen fixation (combining atmospheric nitrogen with other elements), and nitrogen uptake by plants and microorganisms [11].

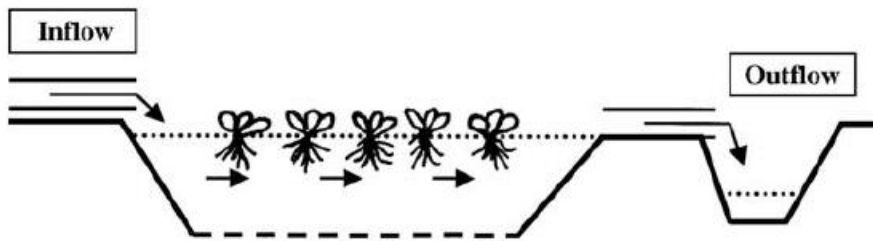

FIGURE 1. Surface flow wetlands with free-floating plants [12]

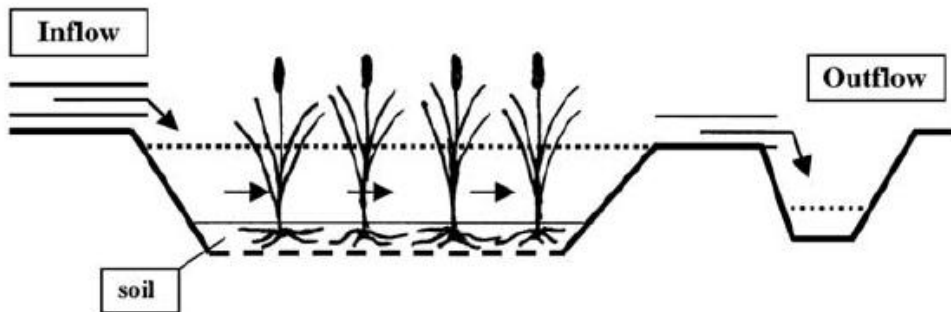

FIGURE 2. Surface flow Wetlands with emergent plants (macrophytes) [12]

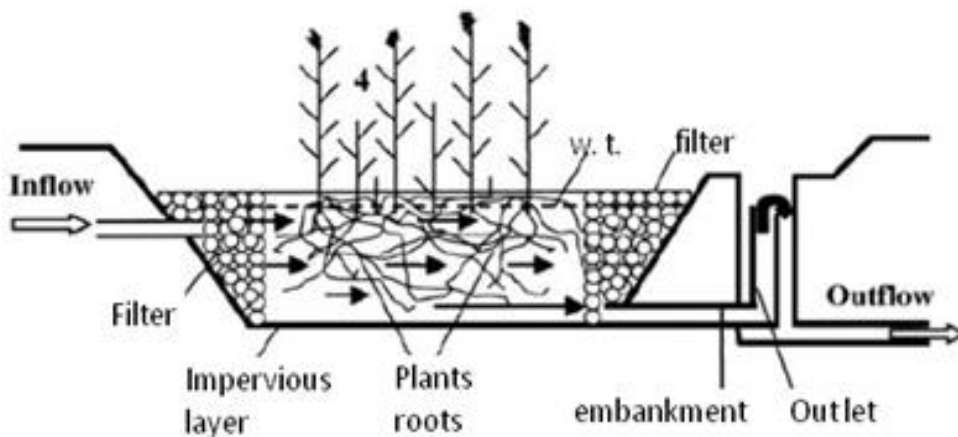

FIGURE 3. Wetlands with horizontal sub-surface flow [13]

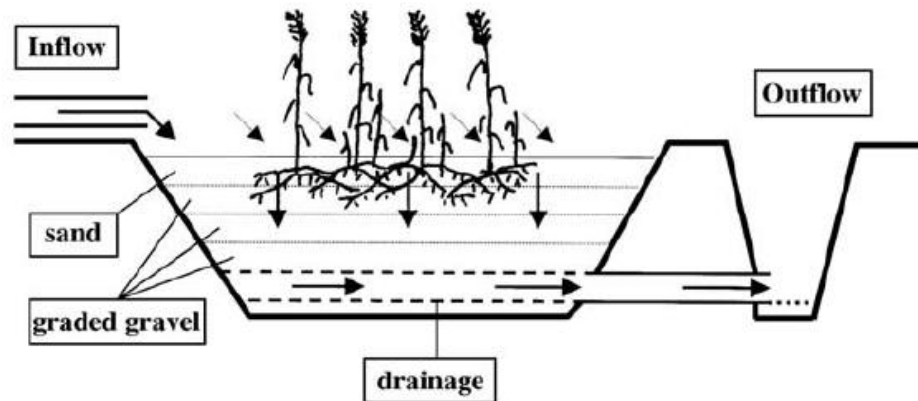

FIGURE 4. Wetlands with vertical sub-surface flow

### 3.1. ROLE OF PLANTS IN CONTAMINANTS REMOVAL

Planted wetlands perform better depollution than unplanted systems. Plants have direct and indirect roles in the pollution removal in wetlands. The direct role of plants on the removal process is the plants uptake of pollution in their tissues. The indirect role of plant in the removal process is their supports for the microbial communities that are exist in the plant root zone. It is documented that plants support the survival of microorganisms live in the root zone (rhizosphere), those have main role in the removal of contaminants [12, 13].

Plants can remove nutrient by uptake to their tissues up to 23%. Stimulation of microbial activities in the plants root zone doubled the pollutant removal compared to unplanted systems [14]. Also, plants roots improved the filtration of pollutant suspended particles by 22% in contrast to unplanted systems [11, 15].

### 3.2. ROLE OF MICROORGANISMS IN CONTAMINANTS REMOVAL

Plant roots emanate oxygen, nutrition and organic carbon for denitrifier microorganisms which stimulate the nitrite removal process in constructed wetland systems [14, 16].

Wetland systems showed high percentage of pathogen die-off rates for wastewater treatment plant effluent. Mechanism of bacteria die-off in wetlands can be result of complex relation chain in the system between different microorganisms such as predation, microbial competition, attack by lytic bacteria and phages (viral infection of bacteria). Approximately 90 percent of pollutant removal in wetlands resulted from natural chemical processes such as periphyton. Also other processes take place or exist in wetlands can have a significant role in bacterial removal such as sedimentation, sunlight, absorption and natural die-off [14, 17, 18, 19, 20].

#### 4. DESIGN CRITERIA FOR CONSTRUCTED WETLANDS

Karem [8] examined the pathogen reduction in vegetated wetlands receiving runoff from lands and wastewater. The effect of different aquatic plants on the fecal bacteria die-off in wetlands was assessed as well. To calculate die-off for bacteria, the following equation (1) was suggested:

$$\log_{10} N_t/N_o = -2mx + b \quad (1)$$

Where:  $N_t/N_o$  is the ratio of the bacteria number value at time (t) to the initial value (o), x is the time in days, b and m are constants.

Farooqi [21] suggested equation (2) for calculating the surface flow wetland surface area.

$$A = Q \ln(C_{in} - C_{out}) K_{BOD} d n_v \quad (2)$$

Where A is the wetland area ( $m^2$ ), Q is the influent wastewater flow rate ( $m^3/day$ ),  $C_{in}$  the influent BOD (mg per L),  $C_{out}$  the effluent BOD (mg per L) and  $K_{BOD}$  is the rate constant (0.067-0.19) ( $day^{-1}$ ), d is the depth of water in the wetland (m) and  $n_v$  is porosity of wetland material.

Vymazal [9] presented equation (3) for calculating the area of horizontal wetland for waste treatment. The thickness of filtration bed in horizontal flow constructed wetlands is about 0.6–0.8 m, to permit plants roots go through the whole bed to ensure the release of survival essential materials (oxygen and nutrients) for living microorganisms in the root zone.

$$A_h = \frac{Q_d [\ln(C_{in}) - \ln(C_{out})]}{K_{BOD}} \quad (3)$$

Where  $A_h$  is the area surface flow of bed ( $m^2$ ),  $Q_d$  the average inflow to the wetland ( $m^3$  per day),  $C_{in}$  the influent BOD (mg per L),  $C_{out}$  the effluent BOD (mg per L) and  $K_{BOD}$  is the rate constant (0.067-0.19 per day).

As an estimate for the required area for wastewater removal per capita, a 50% removal of nitrogen from municipal sewage can be achieved by using 5  $m^2$  wetland bed area per single population equivalent [17].

#### 5. CONCLUSION

Wetland can be used as a cost effective environmental friendly treatment plant due to its lower cost of construction, maintaining and running comparing to conventional treatment plants. It also removes pollutants and pathogens in natural pathways without releasing any chemical unwanted or harmful by-products, safeguarding aquatic ecosystems, reducing energy usage, minimizing greenhouse gas emissions.

Constructed wetlands remove contaminants from surface water by vague combined effects of physical, chemical and biological processes. According to the hydrology of the system, two types of wetlands are exist, surface and subsurface flow wetlands.

Planted wetland systems have better removal performance compared to unplanted systems. Plants have direct and indirect affect on wetlands removal capacity, the direct effect of plants in removal is by uptake of nutrition; while the indirect effect of plant root systems improves removal and stimulated microbial activities. A 50 percent removal of nitrogen from municipal sewage can be achieved using 5 m<sup>2</sup> of wetland area.

The single-stage constructed wetlands cannot achieve high removal of total nitrogen, because both aerobic and anaerobic processes are not possible to occur in one type of wetland. Therefore the use of a mixture of surface and subsurface constructed wetlands in serious is recommended to combine the advantages of both wetland types for wastewater treatment.

## REFERENCES

- [1] G. Tchobanoglous, F.L. Burton, and H.D. Stensel. "Wastewater Engineering: Treatment, Disposal, and Reuse," Meltcalf & Eddy, Inc.'s, 4th Edition. McGraw-Hill, Inc., New York. 1819 pp. 2003.
- [2] J.H. Lee, K. W. Bang, "Characterization of urban stormwater runoff," *WaterRes.* 34, pp.1773–1780, 2000.
- [3] M. Muhammad,, M. Baiy, M. Murtatu, and R. Ishtiaq, "Constructed Wetland: An Option for Wastewater Treatment in Pakistan," *EJ. Environmental, Agricultural and Food Chemistry*, 3, pp.739– 742, 2004.
- [4] L. Sala and M. Serra, "Towards sustainability in water recycling," *Water Sci.Tech.*50, pp. 1–8, 2004.
- [5] S.E. Hrudey and E.J. Hrudey, "Safe Drinking Water: Lessons from Recent Outbreaks in Affluent Nations," IWA publishing, Komwall, UK, 2004.
- [6] Y.A. Hamaamin, U. Adhikari, A. P. Nejadhashemi, T. Harrigan, and D. M. Reinhold. "Modeling Escherichia coli removal in constructed wetlands under pulse loading," *Water research* 50, pp.441-454, 2014.
- [7] G.A. Boorman, V. Dellarco, J.K. Dunnick, R.E. Chapin, S. Hunter, F. Hauchman, H. Gardner, M. Cox and R.C. Sills, "Drinking water disinfection byproducts: review and approaches to toxicity evaluation," *Environ. Health Perspect.* 107, pp. 207–217, 2000.
- [8] M. Greenway, "The role of constructed wetlands in secondary effluent treatment and water reuse in subtropical and arid Australia," *Ecological Engineering*, 25, pp. 501-509, 2004.
- [9] J. Vymazal, "Horizontal sub-surface flow and hybrid constructed wetlands systems for wastewater treatment," *Ecological Engineering* .25, pp. 478–490, 2005.
- [10] K. Kelvin and M. Tole, "The Efficacy of a Tropical Constructed Wetland for Treating Wastewater During the Dry Season: The Kenyan Experience," *Water Air Soil Pollutant*, 215, pp.137–143, 2011.
- [11] C. Lee, T.D. Fletcher, and G. Sun, "Nitrogen removal in constructed wetland systems," *Eng. Life Sci.*, 9, pp. 11–22, 2009.
- [12] J. Vymazal, "Removal of nutrients in various types of constructed wetlands," *Science of the Total Environment*, 380, pp. 48–65, 2007.
- [13] M. Kaseva, "Performance of a sub-surface flow constructed wetland in polishing pre-treated wastewater – a tropical case study," *Water Res.*, 38, pp.681–687, 2004.

- [14] M. McCarthy, P. Lawlor, M. Gutierrez and G. Gardiner, "Removal of Salmonella and indicator micro-organisms in integrated constructed wetlands treating agricultural wastewater," *Journal of Environmental Science and Health Part A*. 46, pp,764–770, 2011.
- [15] C.C. Tanner, R.H. Kadlec, M.M. Gibbs, J.P.S. Sukias, and L.M. Nguyen, "Nitrogen processing gradients in subsurface-flow treatment wetlands," *Ecol Eng.*, 18, pp. 499–520, . 2002.
- [16] A. Hedmark, and M. Jonsson, "Treatment of log yard runoff in a couch grass infiltration wetland in Sweden," *International Journal of Environmental Studies*, 65, pp. 267–272, 2008.
- [17] M. Scholz, and B. H. Lee, "Constructed wetlands: a review," *International Journal of Environmental Studies.*, 62, pp. 421–447, 2005.
- [18] L. Boutilier, R. Jamieson, R. Gordon and C. Lake, "Modeling E.coli fate and transport in treatment wetlands using the water quality analysis and simulation program," *Journal of Environmental Science and Health, Part A*. 46,pp. 680–691, 2011.
- [19] M.R. Karim, E. P. Glenn, and C. P. Gerba, "The effect of wetland vegetation on the survival of Escherichia coli, Salmonella typhimurium, bacteriophage MS-2 and polio virus," *Journal of Water and Health*, 6, pp. 167-174, 2008.
- [20] A. Bialowiec, L. Daviesb, A. Albuquerquec, and P. F. Randersonb, "The influence of plants on nitrogen removal from landfill leachate in discontinuous batch shallow constructed wetland with recirculating subsurface horizontal flow," *Ecological Engineering*. 40, pp. 44– 52, 2012.
- [21] I. H. Farooqi, F. Basheer, and R. J. Chaudhari. "Constructed Wetland System (CWS) for Wastewater Treatment." In *Proceedings of Taal2007: The 12th World Lake Conference, 2007, Vol. 1004, pp. 1004-1009.*

## Sustainable Concrete by Using Fly ash as a Cement Replacement

Daban A. Muhedin<sup>1</sup>, Ahmed J. Hama Rash<sup>2</sup>, Madih I. Hamakareem<sup>3</sup>

<sup>1,2&3</sup>Geotechnical Engineering Department, Koya University, Koya, KRG-Iraq

<sup>1</sup>*daban.abdulhahir@koyauniversity.org*, <sup>2</sup>*ahmed.jabar@koyauniversity.org*,

<sup>3</sup>*madeh.izat@koyauniversity.org*

### ABSTRACT

The term of sustainability gets more popularity among architectures, engineers and owners of newly designed buildings. Engineers try to produce new designs and make a link between long-life structures and more environmental friendly buildings. Using fly ash is an effective way to make concrete much more sustainable with less impact on environment, energy and reduces CO<sub>2</sub> emissions as well. This was achieved by partial replacement of cement with high volume of fly ash. In this study five basic concrete mixes were considered, first mix was ordinary Portland cement with no replacements, other four mixes were cement replaced with fly ash by the following percentages 15%, 25%, 35%, and 50%. Compressive strength of concrete was investigated and found that mixes containing 15% of fly ash gave the best result (50 MPa) in 28 days. It is recommended to test these mixes before use in construction projects.

**Keywords:** Portland Cement, Fly Ash, Sustainability, Compressive Strength, Durability.

### 1. INTRODUCTION

Fly ash, which is a waste material that produced by thermal power plants in large quantity, is used in concrete as a mineral admixture to improve the durability and compressive strength of concrete. Fly ash not only used in normal buildings but also used in various infrastructures such as long span bridges, high rise buildings, dams and tunnels to achieve durability in concrete and to avoid micro-cracks that come from too much heat of hydration due to use large quantity of cement [1]. Fly ash not only improves the engineering characteristics of concrete but also it has a good impact on environment. Manufacturing each Kilogram (Kg) of Portland cement emits almost 1 Kg of CO<sub>2</sub> to the atmosphere [2]. Thus, construction materials contribute to 5-8% of all worldwide anthropogenic CO<sub>2</sub> emissions [3]. Obviously, raw materials are finite resources and one day will be finished in nature, so concrete structures are designed for life time of 50 years. With the help of being performing some concrete mixtures, some structures now designed for the life time of 100 years which means a great achievement in terms of sustainable development [4]. In addition, just in Turkey every year 15 million tons of fly ash is produced as industrial by-product material from the combustion of thermal power plants and only 1% of this amount is used in construction industry. Thus, to compensate the raw materials that minimized continually from nature, the rate of using fly ash should be increased [5]. The main aim of this paper is to investigate the compressive strength of concrete in which cement is replaced by fly ash with up to 50%. To achieve this goal a target of 28 day compressive strength of 30 MPa was prepared.

## 2. EXPERIMENTAL PROCEDURE

### 2.1 MATERIALS AND CONCRETE MIX DESIGN

Five different mixes were investigated for the concrete with natural aggregate. The first mix was a control mix and did not contain any fly ash while in other four mixes the cement was replaced by fly ash with 15%, 25%, 35% and 50% respectively. The cement used was Type 1 ordinary Portland cement. The fly ash used was complying with ASTM 618 with natural, round and smooth aggregate sieved to 19mm. Both coarse and fine aggregate were washed, dried, and been kept for 24 hours before use as shown in Figure 1. Different water/cement ratio has been employed for all the mixes which are shown in Table 1. All mixes were designed based on ACI 211 Report [6]. The amount of materials is shown in Table 1.



FIGURE 1. Preparing the samples

TABLE 1.  
Quantities of used materials in Kg/m<sup>3</sup>

Item	Cement	Fly ash	Sand	Aggregate	Water	w/c ratio
0 % fly ash	457.7	0	612.7	1143.5	200	0.437
15% fly ash	389	68.7	612.7	1143.5	180	0.393
25% fly ash	343.3	114.4	612.7	1143.5	180	0.393
35% fly ash	297.5	160.2	612.7	1143.5	200	0.437
50% fly ash	228.9	228.9	612.7	1143.5	200	0.437

### 2.2 MIXING AND CASTING PROCEDURE

All concrete mixes were prepared and mixed in a laboratory pan mixer. After drying fine and coarse aggregate they were blended for about 1 minute. Then cement and fly ash were added and blended for one more minute, and then water was added to the mix gradually to obtain a uniform batch. Cube samples were casted and compacted using a vibrating table until large bubbles were removed from cubes.



### 2.3 CONCRETE MECHANICAL PROPERTY (COMPRESSIVE STRENGTH)

This study mainly focuses on compressive strength of concrete because it is the most important required factor by structural designers. Concrete samples were casted in cubes of 100mm, 100mm, 100mm dimensions and samples were cured for periods of 28, 60 and 90 days. It is reported by [7] that the fly ash has a negative effect on early ages strength of concrete. Therefore, later ages such as 60 and 90 days were chosen to examine the long term effect of fly ash on the strength. After curing the specimens were kept in a water tank for each period, three samples were tested per mix at each age i.e. 45 cubes were tested in total.

## 3. RESULTS AND DISCUSSION

### 3.1 WORKABILITY

Except for first concrete mixture which contains no fly ash other mixtures show a good workability in laboratory conditions. In other words, using fly ash leads to reduce w/c ratio up to a certain amount. Previous studies show that the shape particles of fly ash are spherical which help to mix particles easily and this fact could be felt during work. As shown in table 1 adding 15% of fly ash causes reducing water by 10% to produce the same level of slump as plain concrete. Reduce water from 200 Kg/m<sup>3</sup> to 180 Kg/m<sup>3</sup> for the same level of slump will produce more cohesive concrete and reduce segregation. The same situation will be true when cement replaced by 25% of fly ash. These results were consistent with other researcher's results which can be found in literature [9]. However, when the amount of cement are replaced by 35% & 50% the amount of water added by 10% to obtain the same level of slump because the fineness of fly ash. Therefore, the results that obtained from experiments were satisfied with literature.

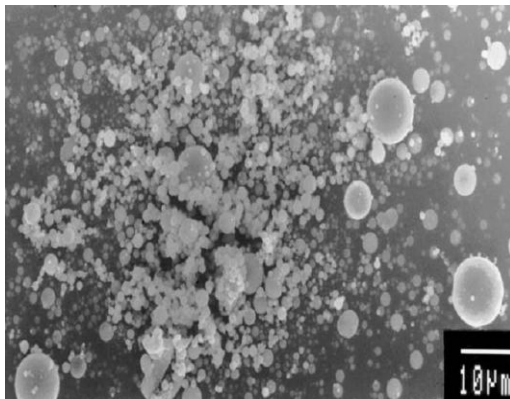

FIGURE 2. Fly ash particles [8]



FIGURE 3. Slump test

### 3.2 COMPRESSIVE STRENGTH AT 28 DAYS

The strength of concrete is the property most valued by structural designers and quality control engineers because if the compressive strength of concrete achieved the required strength at 28 days it means the cube sample results are accepted. But, in fact



there are some other factors that effect on the properties of concrete in short and long term for example porosity, w/c ratio, curing, and types of aggregates. Porosity is an important factor that has fundamental inverse relationship with strength [10]. Since fly ash particles are finer than cement particles that would reduce the concrete porosity and improve permeability as well, this answer can be seen when cement replaced up to 15% of fly ash and then at 28 days a higher compressive strength can be obtained compared to normal Portland cement (average of 48.75 MPa vs. 44.87 MPa) respectively. Even, when using fly ash up to 25% almost an average of 42.33 MPa can be obtained. In addition, w/c ratio is another important aspect in determining the strength of concrete. Regarding to figure 2 that shows fly ash particles are spherical which leads to improve the workability of concrete paste. This can be taken as an evident that 15 & 25% of replacing fly ash need less water as shown in table 1 and caused to increase the strength of concrete. As a result, it can be said that replacing cement by up to 25% of fly ash given a required strength at 28 days with less w/c ratio and more workable cement paste.

However, in commercial practice the dosage of fly ash is limited to 15%- 20% by mass of the total cementitious material [4] but in this study cement was replaced to fly ash up to 35% and 50%. The reason why limited to use fly ash up to 20% because it has a beneficial effect on the workability and cost of concrete but it may not be enough to sufficiently improve against sulfate attack and durability of concrete. This research shows that using fly ash by 35% and 50% has a negative impact on early strength and longer initial setting time due to the low reactivity of fly ash. An average of 26.55 MPa and 24.12 MPa were obtained for replacing fly ash for 35% and 50% respectively. Some research has been carried out to overcome this problem by activating fly ash. One method was to add an alkali activator such as 1 or 2% NaOH or KOH into concrete mix. Another way to get the same outcome was to use lime to mix with fly ash for a few days before incorporating the fly ash into the concrete mix [11]. Therefore, it is not recommended to use fly ash more than 25% at 28 days.

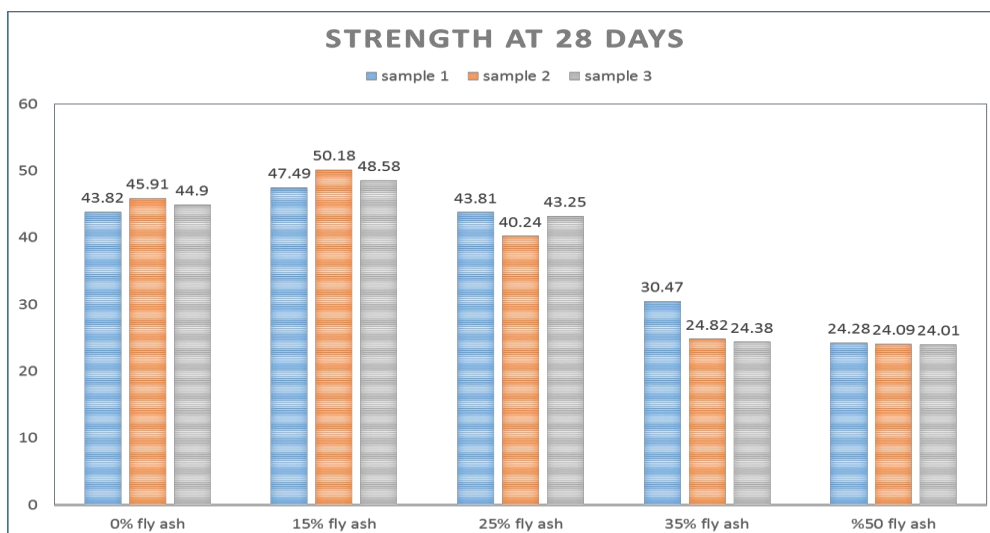

FIGURE 4. Strength at 28 days

### 3.3 COMPRESSIVE STRENGTH AT 60 DAYS

It has been said that using fly ash as cement replacement has a negative impact on early strength of concrete so the 60 and 90 days period has been considered. It has been shown that replacing cement by 15% with fly ash had the highest compressive strength by an average of 51 MPa, then 25% of fly ash given an average of 50.55 MPa at the same period. The abovementioned results show a good performance of fly ash when replaced instead of Portland cement. In case of 35% - 50% of using fly ash an average of 33.3 & 29.70 MPa can be obtained for 60 days span. In conventional design method structures are designed based on 28 days concrete compressive strength. But if the time is not a big issue structures could be designed for long life service with better durability and more sustainability particularly during designing of infrastructures such as dams and other concrete mass structures.

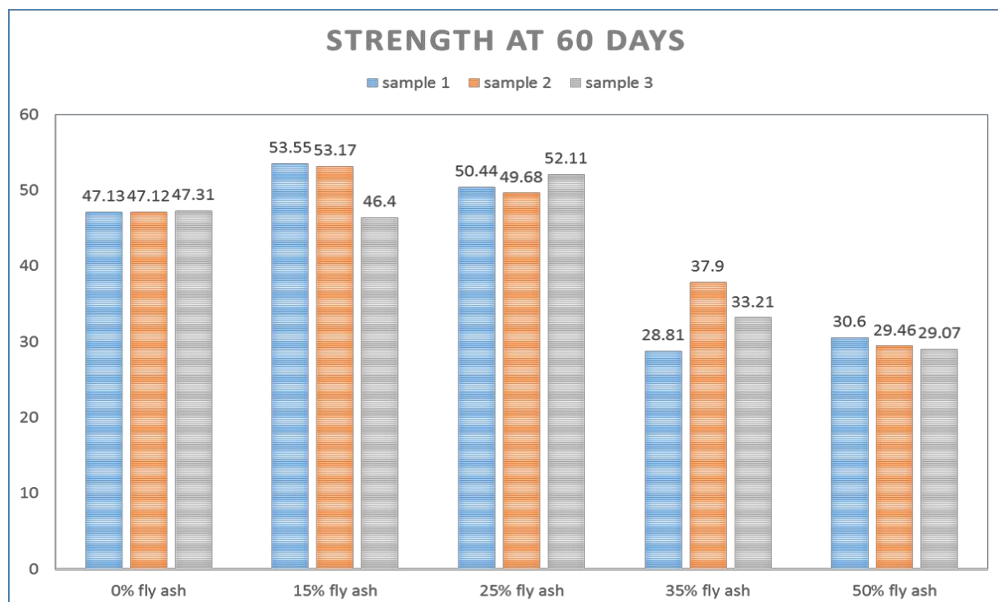

FIGURE 5. Strength at 60 days

### 3.4 COMPRESSIVE STRENGTH AT 90 DAYS

It can be seen from figure 6 that 0% of fly ash i.e. concrete with no replacement of fly ash had an average of 48.75 MPa whereas the average was 44.87 MPa at 28 days which can be seen as small improvements in term of strength. Meanwhile, at 90 days strength of concrete containing 50% of fly ash had an average of 33.3 MPa that means more 9 MPa higher than normal Portland cement at 28 days which was almost 24.12 MPa. Without considering time, fly ash can be used up to 50% and get the required strength at 90 days and solve slow early strength of concrete by using superplasticizer or alkali activators. As shown in table 1, 457.7 Kg of normal Portland cement was required for 1m<sup>3</sup> of concrete, but if cement was replaced by fly ash up to 50% this amount will reduce to 228.9 Kg of Portland cement that leads to save 228.9 Kg of Portland cement and save 228.9 Kg of CO<sub>2</sub> emits into the atmosphere.

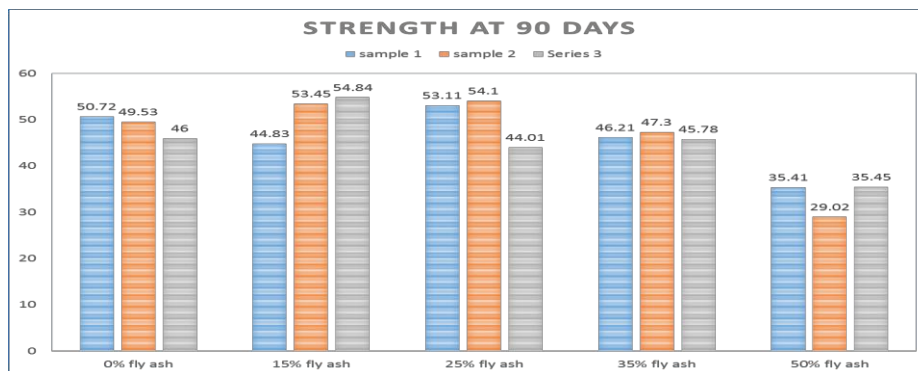

FIGURE 6. Strength at 90 days

#### 4. CONCLUSION

This study shows that fly ash can be used up to 25% as cement replacement and obtain required compressive strength at 28 days. Without considering time fly ash can be used up to 50% at 90 days and apply this concept in dam constructions because it had less strength development which means less temperature produced due to the heat of hydration. Actually, fly ash is a waste material and could be useful for both economy and environment. In other words, The goal can be a achieved with using fly ash in concrete structures not only in terms of environment, but also improving the structural properties as well, such as compressive strength of concrete structures.

#### REFERENCES

- [1] S. C. Maiti, R. C. Wason, H. K. Julka and A. Maidasani, "Development of mix proportioning procedure for flyash concrete," in *27th Conference on Our World Concrete & Structures*, Singapore, 2002.
- [2] C. V. Nielsen, "Carbon footprint of concrete buildings seen in life cycle perspective," *Concrete technology forum*, pp. 1-14, June 2008.
- [3] P. Duxson and J. Provis, "Low CO2 concrete: are we making any progress," *Royal Australian Institute of Architects*, pp. 1-8, November 2008.
- [4] P. K. Mehta, "High-performance, high-volume fly ash concrete for sustainable development," California, 2004.
- [5] O. Celik, E. Damc and S. Piskin, "Characterization of fly ash and it effects on compressive strength properties of Portland cement," *Indian journal of engineering*, vol. 15, pp. 433-440, October 2008.
- [6] I. Kett, *Engineered Concrete Mix Design and Test Methods*, Florida: CRC press, 2000.
- [7] V. M. Malhotra, G. G. Carette and A. Bilodeau, "Mechanical properties and durability of polypropylene fiber reinforced high-volume fly ash concrete for

shotcrete application," *ACI material journal*, vol. 91, pp. 478-486, October 1994.

- [8] P. C. Aitcn, *Binders for Durable and Sustainable Concrete*, London: Taylor & Fracis, 2008.
- [9] M. L. Berndt, "Properties of sustainable concrete containing fly ash, slag and recycled concrete aggregate," *Construction and building material*, vol. 23, pp. 2606-2613, 2009.
- [10] P. K. Mehta, "Concrete structure, Properties and Materials," *Prentice*, 1986.
- [11] Z. Li, *Advanced Concrete Technology*, New Jersey: John Wiley& Sons, 2011.

## Prediction of Time-Dependent Deflection of High Strength Concrete Panels

Prof. Dr. Bayan S. Al Numan<sup>1</sup>, Dr. Faris R. Ahmed<sup>2</sup>

<sup>1</sup> Department of Civil Engineering, Ishik University, Erbil, KRG-Iraq

<sup>2</sup> Civil Eng. Dept, Faculty of Eng, Koya University, Erbil, Iraq

<sup>1</sup>bayan.salim@ishik.edu.iq, <sup>2</sup>faris.rashied@koyauniversity.org

### ABSTRACT

This work presents a model for predicting analytically the time dependent deflection of high strength concrete HSC slabs. This model considers the factors that are significantly influence the long-term deflection of concrete slabs. Realising the effect of time on slab flexural rigidity, the proposed method follow the method of conducting short-term deflection of slabs. The analytical deflection based on the proposed method are compared with the experimental work conducted by the authors in 2005<sup>(1)</sup> and also with several field measured deflections.

**Keywords:** Concrete Panels, High Strength, Two-Way Slab, Long and Short -Term Deflection.

### 1. INTRODUCTION

Calculating deflection in building codes generally depends upon simplification based on tests on S.S. RC beams which results in weak prediction when applied to complex structures<sup>(2)</sup>. True guidance on adequate modeling of time dependent effects (creep and shrinkage) on slab deflection calculations is not found in codes items.

Failures of serviceability of concrete structures are very common involving excessive deflection and/or excessive cracking. Many cases were reported of structures complied to requirements of codes but nevertheless excessive deflected or cracked<sup>(2,3)</sup>. Shrinkage and creep are the primary reason of serviceability failures. For HSC, the difficulty involved in adequate modeling the long-term behavior of concrete slabs, are more than the NSC.

### 2. REVIEW OF PREVIOUS WORKS ON TIME DEPENDENT DEFLECTIONS

Cruz and Mari<sup>(4)</sup> in 1999 presented a model for analytical nonlinear time dependent analysis of reinforced concrete in addition to composite and prestressed concrete structures. For the considered elements, the analysis considers effects of delayed deformations, non-linear material properties, and second-ordered time dependent properties.

Amin Ghali and Azita Azarnejad<sup>(5)</sup> presented a method of analysis to predict the immediate and time dependent strain in RC sections for any concrete strength. The main time dependent parameters required for the analysis are implemented in the method.

Bradford and Gilbert <sup>(6)</sup> presented both the immediate and time dependent response of a RC structure to load. The paper describes a general finite element procedure, based on the so-called layered model, to analyse a RC member. The method forms a general method for analyzing highly indeterminate concrete structures in the time domain.

Bazant and Joong-Koo Kim <sup>(7)</sup> presented a prediction model for the mean (overall) shrinkage strain in cross-sections of long members, which takes into account the influence of environmental humidity, the effective thickness of the member, the effect of cross-section shape, the effect of age at the start of drying, and the effect of temperature. The proposed basic form of the shrinkage formula is justified by nonlinear diffusion theory for the movement of moisture through concrete. The main error of prediction arises from the estimation of the shrinkage parameters from concrete strength and composition.

### 3. EXPERIMENTAL INVESTIGATION

Catroon <sup>(8)</sup> in 2001 reviewed various methods and models for the estimating the deflection of RC two-way slab system mentioned in the literature worldwide. The major influencing factors are the extent of cracking, concrete strength, construction loads, creep and shrinkage. The various methods are applied to compare with reliable experimental works in literature concerning short and long term deflections measured for RC two-way slabs. A proposed model is presented in view of the comparative study of this work. Furthermore, this model takes into consideration the major effective factors including the construction loads as a major factor for multi-story RC building, and also the effect of time dependent factors. This model is presented to be suitable to Iraqi conditions.

Gilbert <sup>(9)</sup> in 2002 addressed the effects of shrinkage on the serviceability of concrete structures. A model is presented for predicting the shrinkage strain in normal and high strength concrete. Analytical and a simplified procedure are presented for including the effects of shrinkage when calculating long-term deflection.

Taha and Hassanain <sup>(10)</sup> described a mathematical model utilizing the theory of error propagation to predict the error in the calculated deflections of simply supported one-way RC slabs. The paper examined the various sources of error associated with deflection calculation for these slabs. A mathematical model was developed to be used for studying the effect of variation of concrete properties as a result of changed site conditions on the accuracy of the estimated deflections.

Faris <sup>(1)</sup> in 2005 cast four slabs marked (L1 to L4) of (960×960×50) mm corresponding to the different types of concrete mixes. Each slab reinforced with one bottom steel mesh of (21φ2.5 Each Way). All slabs were tested on simple supports and in pure bending by uniform load (2.4 kN/m<sup>2</sup> sustained load, and reading the deflection after different periods for 210 days.

### 4. CALCULATION OF SLAB DEFLECTIONS

In this section, prediction of long-time deflections of RC panels are attempted. Reliance shall be made on the most well-known procedures and recommendations.

It is of importance to assess creep and shrinkage values with time. These values depend, in addition to various factors, primarily on the ultimate creep and shrinkage values  $V_u$  and  $(\epsilon_{sh})_u$ .

The initial deflection for uniformly loaded flat plates and two-way slabs can be approximated by Eqs. (1) and (2) <sup>(11,12,13)</sup>:

Flat plates  $d_i = \epsilon_{fp} q L^4 / E_{ci} I$  ..... (1)

Two-way slabs  $d_i = \epsilon_{tws} q L^4 / E_{ci} I$  ..... (2)

Where: I, the moment of inertia and q, the load refer to a unit width of the slab. Deflection coefficients,  $\epsilon_{fp}$  and  $\epsilon_{tws}$  are given in Tables (1) and (2) for interior panels. Note that these coefficients are dimensionless, so that q must be in load/length (kN/m).

**TABLE 1.**  
Deflection Coefficients,  $\epsilon_{fp}$  and  $\epsilon_{tws}$ , for Interior Panels ( $\times 10^{-5}$ )

Type	Interior Panel Support		l/s						
			1.0	1.1	1.2	1.3	1.4	1.5	
$\epsilon_{fp}$ flat plates	Zero edge beam stiffness	C/t	0.0	581	487	428	387	358	337
			0.1*	441	372	320	283	260	243
$\epsilon_{tws}$ Two- way slabs	Elastically supported edges. The appropriate coefficient is in between the case of zero edge beams	Relatively flexible edge beams (total depth about 2t)*	308 to 250	330 to 230	290 to 210	260 to 190	240 to 170	230 to 160	
	Stiffness (flat plate) and infinitely stiff edge beams (rigid supports).	Relatively stiff edge beams (total depth about 3t)*	290 to 170	260 to 140	230 to 120	210 to 105	190 to 90	180 to 80	
	Rigid supports. Built-in edges on infinitely stiff edge beams.		126	102	83	67	54	43	
* Approximate vales			$c/l$ = column/span ratio, $l/s$ = longer / shorter span ratio						

**TABLE 2.**  
Deflection Coefficients (of  $qL^4/D$ ) of Flat Plate Interior Panels <sup>(23)</sup>

Centre of Panel			
c/t ratios	0.0	0.1	0.2
S/L			
1.0	0.00581	0.00441	0.00289
0.8	0.00420	0.00301	0.00189
0.6	0.00327	0.00234	0.00143
0.4	0.00284	0.00205	---

where: c = size of square column. L = long span, S = short span, q = load per unit area.  $D = Et^3/12 (1-\nu^2)$ , t = slab thick,  $\nu$  = Poisson's ratio, E = modulus of elasticity.

### 5. FLEXURAL RIGIDITY OF SLABS

The slabs flexural rigidity varies due to the effects of cracking, creep and shrinkage. Cracking should be taken into account in prediction of slab deflections.

The American Concrete Institute code <sup>(1)</sup> recommends the use of an effective moment of inertia,  $I_e$ , suggested by Branson <sup>(14, 15)</sup>, given by:

$$I_e = \left(\frac{M_{cr}}{M_a}\right)^3 I_g + \left[1 - \left(\frac{M_{cr}}{M_a}\right)^3\right] I_{cr} \leq I_g \dots\dots\dots (3)$$

Where:  $I_g$ = gross moment of inertia of concrete section;  $I_{cr}$ =moment of inertia of the cracked transformed section;  $M_{cr}$ =cracking moment and  $M_a$ =applied moment.

The position of the neutral axis ( $kd$ ), where  $d$  is the effective depth of a singly reinforced rectangular section, has to be determined before calculating  $I_{cr}$

The following expressions are established (for a cracked elastic transformed section):

$$k = \sqrt{(\rho n)^2 + 2\rho n} - \rho n \dots\dots\dots (4)$$

$$I_{cr} = \frac{1}{3} b (kd)^3 + n A_s (d - kd)^2 \dots\dots\dots (5)$$

Where;  $n$ : modular ratio=  $E_s/E_{ci}$

$E_s$ = modulus of elasticity of steel =200 000 MPa, and

$E_{ci}$ = initial modulus of elasticity of concrete may be determined from Eq. (11).

### 6. SLAB DEFLECTIONS DUE TO LONG-TERM LOADS

Under sustained loads, deflections are increased considerably due to creep and shrinkage effects.

Additional long-term deflections due to the mentioned time-dependent effects shall be calculated by multiplying the short-term deflection by the factor<sup>(16)</sup>

$$\lambda = \frac{\varepsilon}{1 + 50\rho'} \dots\dots\dots (7)$$

Where:  $\rho'$ =  $A_s'/bd$ , the compression steel ratio, and  $\varepsilon$  is a time-dependent coefficient. This factor = 2 in slabs since compression steel is generally not used.

To examine the behaviour of a singly reinforced rectangular section under sustained load, see Figure (1). The concrete strain, at top fiber, increases. The strain diagram rotates and the neutral axis moves down as a result of creep.

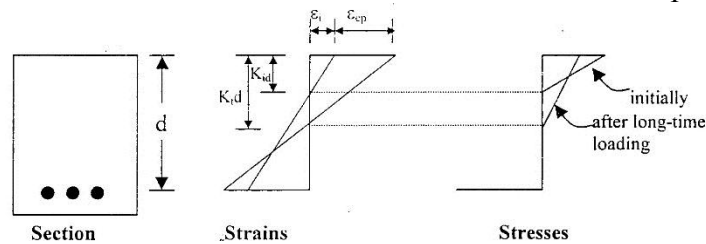

FIGURE 1. Strain and stress distributions initially and after long-time loading in a flexural member

### 7. PROPOSED CALCULATING MODEL FOR LONG TERM DEFLECTION

A procedure is proposed for calculating long-term deflection similar to that of the short-term deflection (Eqs. 1 and 2) as follows:



### 7.1 LONG-TERM FLEXURAL RIGIDITY OF SLABS

In this proposal, the analysis shall be made on "aged" RC sections. The use will be made here of  $E_{c(t)}$  to mean the age-adjusted effective modulus of elasticity and  $I_{e(t)}$  to mean the moment of inertia of an age-adjusted section in which the transformed section is composed of the area of concrete plus  $(E_s/E_{c(t)})$  multiplied by the area of steel. The age-adjusted modulus of elasticity is defined by <sup>(11, 17)</sup>:

$$E_{c(t)} = E_{ci} / (1 + \chi v_t) \dots\dots\dots (8 a)$$

Where:  $v_t =$  creep coefficient at time  $t = \frac{(t - t_o)^{0.6}}{10 + (t - t_o)^{0.6}} v_u \dots\dots\dots (8b)$

Where:  $v_u =$  ultimate creep coefficient <sup>(11)</sup> and  $\chi =$  aging coefficient which depends on age at the time ( $t_o$  or  $t_{\ell a}$ ) when the structure begins carrying the load and on the load duration, table (3),  $(f'_c)_t$  is the compressive strength at later ages and  $f'_c$  is the 28-day compressive strength.

TABLE 3.  
Aging Coefficients ( $\chi$ )

$t - t_{\ell a}$ days	$v_u$	$t_{\ell a}$ in days			
		$10^1$	$10^2$	$10^3$	$10^4$
$10^1$	0.5	0.525	0.804	0.811	0.809
	1.5	0.720	0.826	0.825	0.820
	2.5	0.774	0.842	0.837	0.830
	3.5	0.806	0.856	0.848	0.839
$10^2$	0.5	0.505	0.888	0.916	0.915
	1.5	0.739	0.919	0.932	0.928
	2.5	0.804	0.935	0.943	0.938
	3.5	0.839	0.946	0.951	0.946
$10^3$	0.5	0.511	0.912	0.973	0.981
	1.5	0.732	0.943	0.981	0.985
	2.5	0.795	0.956	0.985	0.988
	3.5	0.830	0.964	0.987	0.990
$10^4$	0.5	0.501	0.899	0.976	0.994
	1.5	0.717	0.934	0.983	0.995
	2.5	0.781	0.949	0.986	0.996
	3.5	0.818	0.958	0.989	0.997

The report of ACI 209<sup>(11)</sup> recommended that  $v_u = 2.35 \gamma_c$  where  $\gamma_c$  is a factor for correction when different values of ambient relative humidity, average thickness of the member and temperature are involved. For relative humidity of 40%, average thickness of 150 mm and temperature of 21°C, the factor is equal to 1.0.

For moist-cured condition, the factor is calculated as:  $\gamma_c = 1.25 t_o^{-0.118}$ .

The time dependent effective moment of inertia  $I_{e(t)}$  can be computed according to Eq. (3) with the following difference: In computing  $I_{cr(t)}$  the position of the neutral axis is shifted:  $kd$  to  $(kd)_t$ , and the modular ratio  $n = (E_s/E_c)$  is changed into  $n(t) = (E_s/E_{c(t)})$  according to Eq. (8), as follows:

Equilibrium:  $b(kd)_t^2 / 2 = n(t) A_s (d - (kd)_t)$

$$\text{Therefore: } n_{(t)} = \left( \frac{bd}{2A_s} \right) \left( \frac{k_{(t)}^2}{1-k_{(t)}} \right) = \frac{1}{2\rho} \frac{k_{(t)}^2}{1-k_{(t)}} \dots\dots\dots (9)$$

Substituting (9) in (5) gives:

$$I_{cr} = \frac{bd^3}{6} (3k_{(t)}^2) \dots\dots\dots (10)$$

Figure (2) shows that the neutral axis, in a singly reinforced section, move downward after long period of time. The neutral axis moved down 50% more than the initial place after a long time (1000 days).

The long-term flexural rigidity is now defined by Equations (3), (8), (9) and (10). Figure (3) shows how the rigidity is reduced with time. For the slab section described in the figure, about 65% and 40% reduction in the flexural rigidity occurred after 1000 days in the case of un-cracked section  $M_a/M_{cr} \leq 1.0$ , and when cracked with  $M_a/M_{cr} = 2.0$ , respectively.

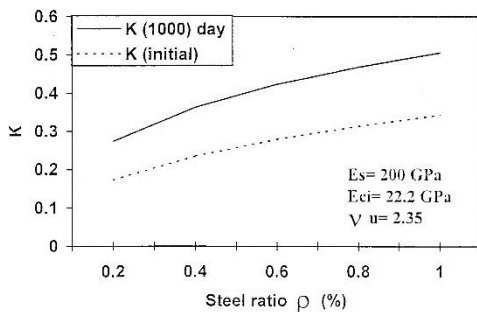

FIGURE 2. Neutral Axis Position of Slab Section (Initially and after Long-Time)

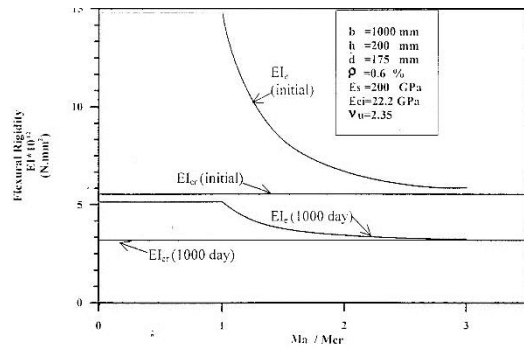

FIGURE 3. Slab Flexural Rigidity (Initially and after Long-Time)

## 7.2 LONG-TERM DEFLECTION OF SLAB

Equations (1) and (2), used basically for short-term deflection calculation, will be used to calculate the long-term deflection of two-way slabs. The flexural rigidity variation as derived in section 8.1 is taken into account.

For various slab systems, it has been shown <sup>(18)</sup> that Eq.(3) can be used along with an average different regional moment values as follows:

Flat plates-  $I_{e(t)}$ , (+ ve) and (- ve), for the long direction column strip.

Slabs with beams-  $I_{e(t)}$ , (+ ve) and (- ve), for the short direction middle strip.

The panels' centres are generally considered un-cracked.

## 8. COMPARISON WITH FIELD-MEASURED LONG-TERM SLAB DEFLECTIONS

Table (4) lists the results of this paper with experimental-measured 7-month deflections of reference 1. Good correlation between analytical and experimental deflections is shown. The mean of (analytical/experimental) deflections is (1.35) with a coefficient of variation of (1.45) percent.

TABLE 4.  
Comparison of Measured and Calculated total Deflections

Slab Designation	Measured Deflections; mm	$f'_c$ ) <sub>28</sub> MPa *	Calculated Deflections; mm	Calc/Meas Ratio
L1	2.45	63.5	2.955	1.21
L2	2.17	64.77	2.932	1.35
L3	2.015	65.1	2.926	1.45
L4	2.85	24.74	4.189	1.47

Needless to say that more experiments are needed on long term deflection of HSC slabs to effectively verify the present model. Field data on long-term deflections of HSC slab systems are scarce and not found.

However, several investigations <sup>(19, 20, 17, 21, 22)</sup> have been reported on NSC and lightweight concrete two-way slabs. Table (5) presents information of long-term deflections results. Moduli of elasticity are estimated using ACI expression, or using the authors':

$$E_c = 0.043 W_c^{1.5} \sqrt{f'_c} \quad \text{For NSC ..... (11 a)}$$

$$E_c = (3320\sqrt{f'_c} + 6895) \left( \frac{W_c}{2320} \right)^{1.5} \quad \text{For HSC } ^{(2)} \text{ ..... (11 b)}$$

where:  $W_c$  = Concrete density (kg/m<sup>3</sup>)

Table (5) compares the predictions with the deflection from several references. The ratio between calculated and measured deflections showed a good correlation with mean value of (1.045) and a coefficient of variation of (1.5) percent. The model presented herein requires that the creep characteristics of concrete be accurately estimated, yet such information are absent in the reported investigations. Therefore ACI209 recommendations <sup>(11)</sup> were used in the calculations. Reference 19, however, estimated creep factor for Iraqi concrete to be between (1.9) and (2.2). Creep factor of (2.0) was used in the calculations.

TABLE 5.  
Summary of Data and Comparison of Measured and Calculated Deflections for Long-Term Deflections

References	Struc. Type	Dim m	t mm	Sus. Load kN/m <sup>2</sup>	E MPa	Measured Defl. mm	Calc. Defl. mm	Calc/Meas Ratio
Jawad <sup>(19)</sup>	Flat slab	7.0×7.0	220	7.3	21,700	33.6 (15-year)	38.7	1.152
Jokinen <sup>(20)</sup>	Flat slab	9.0×9.0	200	5.5	27,800	33 (1-year)	36.4	1.103
Taylor <sup>(17)</sup>	Flat plate	6.34×5.07	200	5.5	21,400	24.4 (9-year)	26.1	1.070
Heiman <sup>(21)</sup>	Flat slab	7.54×7.24	240	5.5	28,500	21.6 (9-year)	23.1	1.069
Sbarounis <sup>(22)*</sup>	Flat plate	6.7×6.7	185	4.2	18,000	34.3 (1-year)	28.5	0.831

\* Light weight concrete (1760 kg/m<sup>3</sup>)

## 9. CONCLUSIONS

Conclusions can be drawn as follows:

1. Significant factors influencing long-term slab deflections were taken into account in the proposed analytical model analogous to initial deflection calculation methods considering the degradation of flexural rigidity with time. Thus, it is rational the long-term effects on concrete properties are put into effect.
2. The analytical model considers the decrease of flexural rigidities with time, i.e., the analysis is based on “aged” section.
3. The problem of predicting long-term deflection of concrete members is complex, it involves many factors, most of them are uncertain, such as materials nonlinearity, influence of construction process, creep and shrinkage.
4. Comparison with field measurement found in literature shows good correlation. Calc/measured deflection is 1.18 with coefficient of variation of 4.2%.

## REFERENCES

- [1] Ahmed, F.R., “Punching Strength and Time-Dependent Response of High-Strength Concrete Panels”, Ph.D. Thesis, College of Eng, Baghdad Uni, Iraq, Nov. 2005.
- [2] R.I. Gilbert, "Shrinkage, Cracking and Deflection; the Serviceability of Concrete Structures", Electronic Journal of Structural Engineering, 2001.
- [3] AS3600-1994, Australian Standard for Concrete Structures, Sydney, (1994).
- [4] Cruz P.J.S. and Mari A.R., "Non-Linear Time-Dependent Analysis of Segmentally Constructed Structure Using the Layered Finite Element Method", Structural Engineering and Mechanics, an International Journal, Vol.8, No.6, 1999, pp.561-578.
- [5] Ghali, A., and Azarnejad A., “Deflection Prediction of Members of any Concrete Strength”, ACI Structural Journal, Vol.96, No.5, Sep-Oct 1999, pp.807-816.
- [6] Bradford M. A. and Gilbert, R.I., "Time-Dependent Analysis of Reinforced Concrete Structure Using the Layered Finite Element Method", Structural Engineering and Mechanics, an International Journal, Vol.24, 1991, pp.327-345.
- [7] Bazant and Joong-Koo Kim, "Improved Prediction Model for Time Dependent Deformations of Concrete: Part 1-Shrinkage", Materials and Structures, Vol.24, 1991, pp.327-345.
- [8] Catroon, K.M.S., “Various Procedures for Deflection Computation for Reinforced Concrete Two-Way Slab Systems”, M.Sc. Thesis, College of Engineering, Al-Mustansiriyah University, Baghdad, Iraq, August 2001, 175p.
- [9] Gilbert, R.I., “Shrinkage, Cracking and Deflection: the Serviceability of Concrete Structures” Electronic Journal of Structural Eng, Vol.1, No.1, 2002, (internet paper).
- [10] Taha, M.M.R., and Hassanain, M.A., “Estimating the Error in Calculated Deflections of High Performance Concrete Slabs: A parametric Study Using the Theory of Error Propagation”, (Internet Paper).

Second International Engineering Conference On Developments in Civil &  
Computer Engineering Applications 2016

- [11] ACI Committee 209, 1997, "Prediction of creep, shrinkage, and Temperature Effects in Concrete Structures", ACI Manual of Concrete Practice, Part1, American Concrete Institute, Detroit.
- [12] Vanderbilt, M., D., et al., "Deflections of Multiple Panel Reinforced Concrete Floor Slabs", Proc. ASCE, V.91, ST 4, Aug. 1965, pp.77-101.
- [13] Mehmel, A., "A Rational Limitation of Deflections in Reinforced Concrete Members", Bauingenieur. V. 36, No. 8, 1961, PP. 293- 300.
- [14] Branson, D. E "Instantaneous and Time Dependent Deflections of Simple and Continuous Reinforced concrete Beams", HPR publication 7, Part 1. Alabama Highway Dept., Bureau of public Roads, Ala.
- [15] Branson, D.E., "Deformation of Concrete Structures", McGraw-Hill, 1977, 546 pp.
- [16] ACI Code (318-14), "Building Code Requirements for Reinforced Concrete", American Concrete Institute, Detroit, Mich. 2014.
- [17] Taylor, P.J., and Heiman. J. L., "Long-Term Deflection of Reinforced concrete Flat Slabs and Plates" ACI Journal, Proc. V. 74, No. 11, Nov. 1977, pp. 556-561.
- [18] Matsui, K., "Initial and Time Dependent Deflections of Reinforced Concrete Flat Plates and Two-Way Slabs", Interim Research Report, Uni of Iowa, June 1970.
- [19] Jawad, F.A., "Long-Term Deflection of Two-Way Slab Systems: with Particular Focus on Iraqi Practice", M.Sc. Thesis, College of Engineering, Al-Mustansiriyah University, Baghdad, Iraq, February 2000, 143p.
- [20] Jokinen, E.P. and Scanlon, A., "Field-Measured Two-Way Slab Deflections", Proceedings of the Annual Conference of the Canadian Society for Civil Engineering, Saskatoon, Saskatchewan, 1985, pp. 43-58.
- [21] Heiman, J.L., "A Comparison of Measured and Calculated Deflections on Flexural members in Four Reinforced Concrete Buildings", Deflections of Concrete Structure, SP. 43, ACI, 1974, pp. 515-545.
- [22] Sbarounis, J.A, "Multi-storey Flat Plate Buildings Measured and Computed One Year Deflections", Concrete International: Design and Construction, V. 6, No. 8, Aug. 1984, pp. 31-35.
- [23] Park, P., and Gamble, W.L., "Reinforced Concrete Slabs", N.Y. Published by Wiley and Sons, 1980.

## **Comparison of Mat Foundation Design Using Rigid Method and SAFE Program**

Muhammad Arf Muhammad

*Civil Engineering Department, University of Sulaimani, KRG-Iraq  
muhammad.rashid@univsul.edu.iq*

### **ABSTRACT**

Reinforced concrete mat foundations are popular foundation type commonly used in high rise buildings. These foundation systems may be designed and analyzed as either rigid bodies or as flexible plates supported by an elastic foundation. This research is to compare the similarities and differences of both rigid and flexible methods through the use of mat foundation modelling. A symmetrically loaded mat foundation models with equal column spacing were analyzed and designed using the conventional rigid method procedure and then the same models were reanalyzed and redesigned as flexible bodies using SAFE v12.2 computer program. Consequently among design strips, it has been numerically found that the one way shears achieved by the rigid method are more than those of SAFE program with the considerable fluctuations of their amounts. Thicker mat is required to check punching shear according to SAFE program in comparison with that of the rigid method. Furthermore, the flexural moments gained by SAFE program are more around columns and lesser at strip mid spans comparing to those reached by the rigid method. It can be concluded that there are some differences of the results between both methods. This paper recommends to cautiously use the application program with deeply understanding of input design parameters such as modulus of subgrade soil reaction.

**Keywords:** SAFE Program, Rigid Method, Flexural Moment, Punching Shear.

### **1. INTRODUCTION**

The mat or raft foundation is a continuous footing supporting a group of columns and walls in several lines in each direction. ACI 336 [1] described that mat foundations cover the entire area under a structure or an area of at least 75 percent of total area within the outer limits of the structure.

A reinforced concrete mat foundation is a common structural type of foundation systems used on erratic or relatively weak supporting soil subjected to more substantial loads from the building where a large number of spread footings would be required. In addition, it may be more economical to use a mat foundation when spread footings cover more than one-half the foundation area [1]. Mat foundations are generally used with soil that has a low bearing capacity but mats, often with piles, are also essential to resist uplift hydraulic pressure from those places where water table above the foundation levels [2].

Bowles [2]; Das [3]; Klemencic, et al [4] schematically show several types of mat foundations used currently including flat plate, flat plate thickened under columns, beams and slab, flat plates with pedestals, slab with basement walls as a part of the mat where the walls act as stiffeners for the mat, and mats placed directly above piles. The flat plate type of mat foundations is to be considered in this paper.

The structural analysis of mat foundations can be carried out by two conventional methods: the conventional rigid method and the approximate flexible method as exemplified by Das [3]. Alternatively, the mat is divided into a number of finite elements and three general finite element formulations may also be used involving finite difference, finite grid and finite element methods [1, 2]. One of disadvantages of finite element formulations is computationally intensive but computers and available programs make the use of finite element methods economical and rapid.

The conventional rigid method is characterized by its simplicity and ease in execution. In contrast, the resultant of column loads does not coincide with the resultant of soil pressure under the individual design strips, which leads to violation of the static equilibrium equations. Therefore, ACI 336 [1] restricts the use of conventional rigid method and suggests that mat foundation may be designed by considering design strips both ways and treating the mat as a rigid body where column spacing is less than 1.75 divided by a coefficient ( $\beta$ ) or the mat is very thick, and variation of column loads and spacing is not over 20%.

$$\beta = \sqrt[4]{\frac{\beta_1 Ks}{4E_F I_F}} \dots \dots \dots (1)$$

Where  $Ks$ ,  $E_F$ ,  $I_F$  and  $\beta_1$  modulus of soil subgrade, modulus of foundation material, moment of inertia of strip design beam and strip width, respectively.

Although a variety of commercial computer program is available relating to the analysis and design of mat foundations, the authors avoid to provide recommendations for any specific analysis program [1, 2, 4]. Therefore, before structural designers use a computer software, they need to validate the reliability of the software in terms of both safety and economic aspects.

This study is to compare and show the similarities and differences of both rigid and finite element methods through the use of mat foundation modelling. Mat Foundation models are analyzed and designed as flat plate rigid body using the conventional rigid method and then SAFE v12 based on finite element method is applied to analyze and design the equivalent models. The main focus is to investigate the results obtained from both methods.

The design of mat foundations has long been recognized as a problem in soil-structure interactions that designers have tried to simplify by designing mats that can be classified as rigid bodies [4]. Soil-structure interactions, and soil properties are beyond the scope of this research.

## 2. MAT FOUNDATION MODELLING AND DESIGN PARAMETERS

To design a mat foundation, the geotechnical engineer will need to provide structural engineer with those design parameters relating to supporting soil properties such as allowable bearing capacity ( $q_a$ ), anticipated settlements ( $\delta$ ), and modulus of subgrade reaction ( $Ks$ ). On the other hand, structural engineer will choose any design parameters belonging to construction materials used in the mat. As a result, the appropriate design of any foundation system prerequisites the clear and effective communication between the structural and geotechnical engineers [4]. The process of the mat foundation modelling of this research includes the following steps:

## 2.1 PLAN AND LOADING OF THE MAT FOUNDATION MODEL

Prestigious foundation design textbooks often illustrates conventional rigid method to escape from disequilibrium of the applied loads and soil pressure either by selecting symmetrically-loaded strips and using uniform soil pressure to reduce the eccentricity to zero and avoid serious errors [5]. Therefore, a symmetrically loaded mat foundation models were taken into account with 17m by 12m in plan as shown in Figure 1.

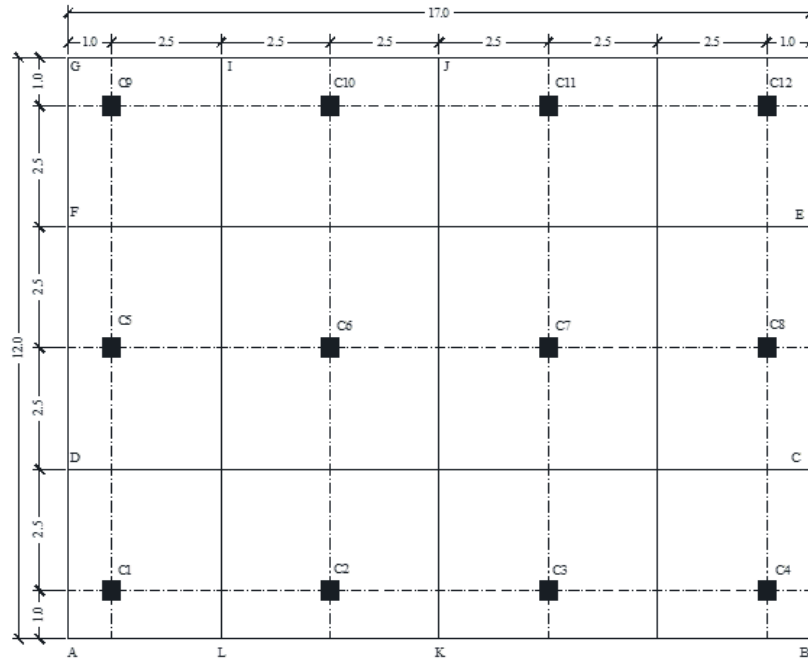

Note; All dimensions are in meters

FIGURE 1. Plan of the mat foundation models

The mat carried the 3 by 2 bays concrete frame with equal column spacing (5m) in both directions (x, y), and cross sections of columns are 0.4m x 0.4m. Realistic dead and live loads were estimated for a 10 story public building frame based on ASCE 7-10 [6] and transferred to the mat using tributary area as presented in Table 1. This paper only considers static gravity loads (service dead and live loads) coming from the superstructure with linear elastic behavior analysis.

TABLE 1.  
Column dead and live loads

Columns	Dead load (KN)	Live Load (KN)
Corner	800	600
Edge	1000	900
Interior	1400	1200

## 2.2 DESIGN PARAMETERS

The mat foundation consists of normal concrete mix and steel reinforcements. The design and analysis of the mat foundation models needs the property of the construction materials and consequently the appropriate design parameters were fixed for both rigid method and SAFE program as shown in Table 2.



Specified compressive strength of concrete ( $f_{c'}$ ) was set to 30 MPa using cylinder specimens and specified yield strength of reinforcement ( $f_y$ ) was indicated as 400MPa. The allowable bearing capacity of soil ( $q_a$ ) used in the conventional method was 120 KN/m<sup>2</sup>. The three parameters plays a significant role in the analysis and design process.

TABLE 2.  
Design parameters

Parameter	Notation	Value
Specified yield strength of reinforcement, MPa,	$f_y$	400
Specified compressive strength of concrete at 28 days, MPa,	$f_{c'}$	30
Modulus of elasticity of reinforcement, MPa,	$E_s$	200,000
Modulus of elasticity of concrete, MPa,	$E_c$	26667
Concrete weight, kg/m <sup>3</sup>	$w_c$	2356
Poisson ratio, concrete	$\mu$	0.2
Allowable bearing capacity, KN/m <sup>2</sup>	$q_a$	120
Modulus subgrade reaction of soil, KN/m <sup>3</sup>	$K_s$	14,400
Bearing capacity factor of safety	FS	3
Mat cover (top, bottom, sides), mm	C	50
Steel Diameter, mm	$\phi$	25

Many empirical equations for predicting the modulus of elasticity for concrete as a function of compressive strength can be found in the literature. According to ACI 318-08 [7], Section 8.5, modulus of elasticity ( $E_c$ ) for concrete has been found using Eq. (2). Modulus of elasticity ( $E_s$ ) for nonprestressed reinforcement shall be allowed to be taken as 200,000 MPa.

$$E_c = w_c^{1.5} 0.043 \sqrt{f_{c'}} \dots \dots \dots (2a)$$

$$E_c = 4700 \sqrt{f_{c'}} \dots \dots \dots (2b)$$

Where;  $w_c$  is normal weight of concrete in kg/m<sup>3</sup>,  $f_{c'}$  and  $E_c$  are in MPa.

By default SAFE uses modulus of elasticity (26667MPa) for 30MPa strength of the concrete. This value is in the range of the results achieved by equations 2a and 2b.

### 2.3 MODULUS OF SUBGRADE REACTION

Soil is naturally non-linear, anisotropic and heterogeneous and its deformation is depended on the stresses that are applied to soil [8]. Hence, for design of the structure supported by soil, instead of modeling the subsoil in all its complexity and various properties, it can be replaced by a simpler parameter called a modulus of subgrade reaction ( $K_s$ ). Accordingly, this parameter plays an important role in all three discrete element methods given for analysis and design of mat foundation [2]. To design reinforced concrete mat foundations in SAFE Program,  $K_s$  is a fundamental parameter that needs to be defined instead of ( $q_a$ ).

It has been frequently stated that Winkler [9] firstly proposed a model to calculate  $K_s$  that was considered as a linear ratio between the contact pressures ( $q_a$ ) and the associated vertical displacement ( $\delta$ ), it has units of force per unit volume (MN/m<sup>3</sup>).

$$K_s = \frac{q_a}{\delta} \dots \dots \dots (3)$$

Reference to the literature review given by Naeini et al [8], Values of Ks may be obtained from the alternative options: field test using ASTM D1194-94; consolidation triaxial laboratory tests; CBR test; or empirical equation and tabulated values [2, 3].

Regarding conventional rigid method,  $q_a$  traditionally used in the design was assumed to be 120 KN/m<sup>3</sup>. Thereafter, it is required to convert ( $q_a$ ) into equivalent Ks. Bowles [2] had reported an empirical relation between allowable bearing capacity of soil ( $q_{all}$ ) and the modulus of subgrade reaction (Ks) of the footing based on a settlement ( $\delta$ ) of 25mm and ultimate bearing capacity ( $q_{ult}$ ). Naeini et al [8] revealed that the equation 3 of Bowles was proposed by geotechnical consultants and therefore in this research the relation was applied to calculate Ks (14,400 KN/m<sup>3</sup>) supposing factor of safety (FS) equal to 3.

$$Ks = 40 FS q_{all} \dots \dots \dots (4)$$

$$q_{all} = \frac{q_{ult}}{FS} \dots \dots \dots (5)$$

### 3. RIGID METHOD DESIGN PROCEDURES

The conventional rigid method assumes two conditions [1]. Firstly, the mat is infinitely rigid, and therefore, the flexural deflection of the mat does not influence the soil pressure distribution. Secondly, the soil pressure is distributed in a straight line or a plane surface such that the centroid of the soil pressure coincides with the line of action of the resultant force of all the loads acting on the foundation. These two conditions may not introduce serious error for very stiff mats with fairly uniform column spacing and loads.

The mat foundation models were analyzed and designed using the conventional rigid method according to the procedure given by Das [3]. The plan of mat foundation models were divided into three design strips (3.5m, 5m, 3.5m) along x direction and four design strips (3.5m, 5m, 5m and 3.5m) in y direction as shown in Figure-1. Note that ACI 318-08 load factors (1.2 for dead loads and 1.6 for live loads) were applied to obtain factored loads.

### 4. SAFE PROGRAM DESIGN PROCEDURES

The equivalent mat foundation models used in rigid method were modelled, analysed, designed and detailed in SAFE v12.2 [10]. Firstly New Model Initialization window was used to choose the design code (ACI 318-08) and metric unit. Then with the help of Base Mat window, the mat was modelled through the input of dimensions of plan and modulus of subgrade reaction.

It is clear that SAFE program is based on finite element method where foundations are analyzed as plates or thick plates on elastic foundations. It uses modulus of subgrade reaction (Ks) that is specified for the foundation model and Ks is automatically converted into the compression of nodal springs.

The mat dimensions were entered in SAFE program and were automatically meshed based upon the maximum mesh dimension, in this model the SAFE program used a default element dimension 1.2 m by 1.2 m with the use of localized mesh and merging points. This meshing dimension was used as a fixed value. However, meshing has effect on the analysis. It is clear that design strips were edited as those used in conventional rigid method, see Figure 1.

The mat thickness is primarily input based on the thickness calculated in rigid method using punching shear provisions of (ACI-318-08, Section 11.11.2.1c) at the typical column locations. The mat thickness was edited and testified for checking it in SAFE program.

## 5. RESULTS AND DISCUSSION

The key parameter relating to supporting soil property is allowable bearing capacity ( $q_a$ ) in rigid method and modulus of subgrade reaction ( $K_s$ ) required in SAFE program. While  $q_a$  has been modeled to be  $120 \text{ KN/m}^2$ , the equivalent  $K_s$  is essential to make the comparison design meaningful. Using the equation 3,  $K_s$  is equal to  $14400 \text{ KN/m}^3$ . Furthermore, a parametric study have been conducted to understand the effect of  $K_s$  on the mat model analysis as flexural moment of Strip ABCD shown in Figure 2.

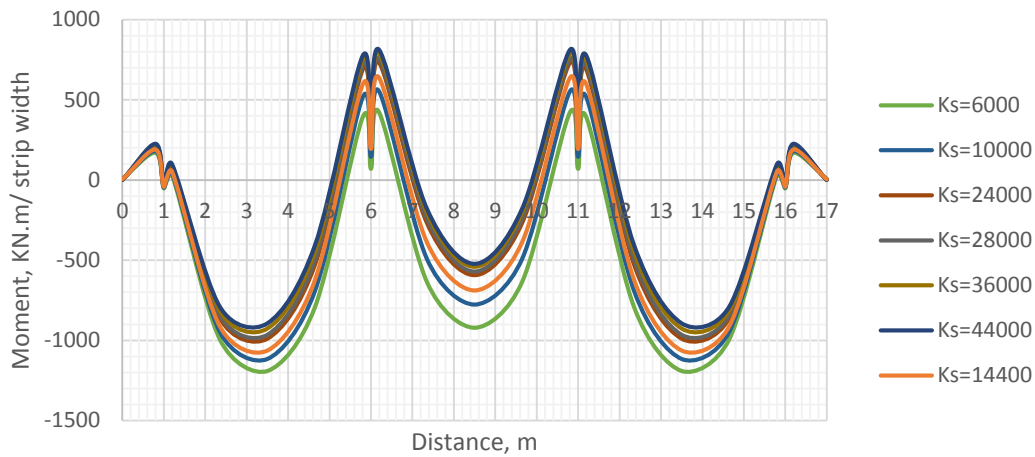

FIGURE 2. Parametric study for different  $K_s$  values of Strip ABCD

The Flexural moment have been drawn according to different  $K_s$  values from (6000 to 44000)  $\text{KN/m}^3$ . It was demonstrated that an increase in  $K_s$  values leads to a decrease of the positive moment in middle span between columns and an increase of negative moment around column loads. Therefore, the more accurate  $K_s$  investigated and evaluated before design, the more reliable design can be achieved in SAFE program.

As far as one way shear forces are concerned, one way shear diagrams per strip widths have been drawn for Strips ABCD, DCEF, ALIG and LKJI as shown in Figures 3 to 6, respectively. It can be noted that the amount of one way shear achieved by conventional rigid method is more than those given by SAFE program with the considerable fluctuations of their amounts among strips. For instance, in design strip ABCD maximum shear force is 1371 KN according to rigid method while SAFE program reports maximum enveloped shear force of 886 KN at the same location.

There are significant differences of one way shear obtained by both analysis procedures. Percent shear force differences of design Strips (ABCD, DCEF, ALIG and LKJI) are 35%, 39.8%, 11.6% and 53.6%, respectively. The differences in edge design strips are less than those of adjacent interior design strips. These differences

could be various depending on column spacing, column loads and edge dimension of the mat plan. One way shear may not be critical in comparison of punching shear in more situation, but one way shear can be predominantly significant where the mats subjected to significant overturning loads from concrete core walls, shear walls, or braced frames [4]. Therefore, these one way shear force differences will need to be taken into consideration.

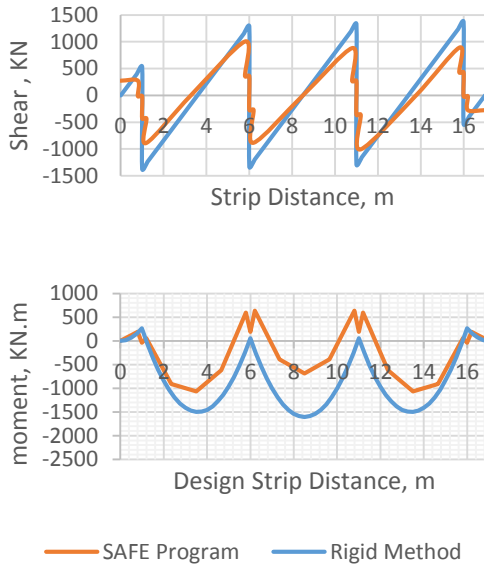

FIGURE 3. one way shear and moments using rigid and SAFE program for Strip ABCD

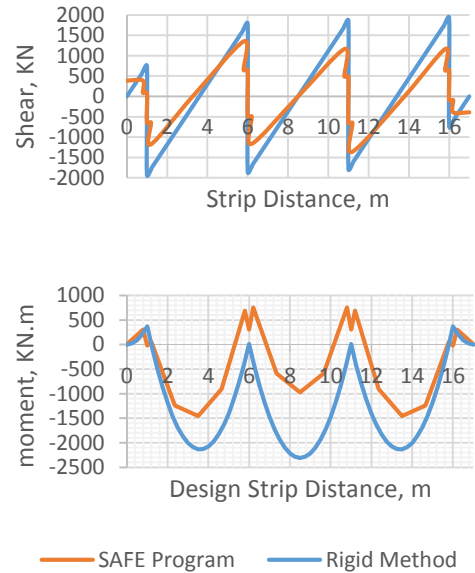

FIGURE 4. one way shear and moments using rigid and SAFE program for Strip DCEF

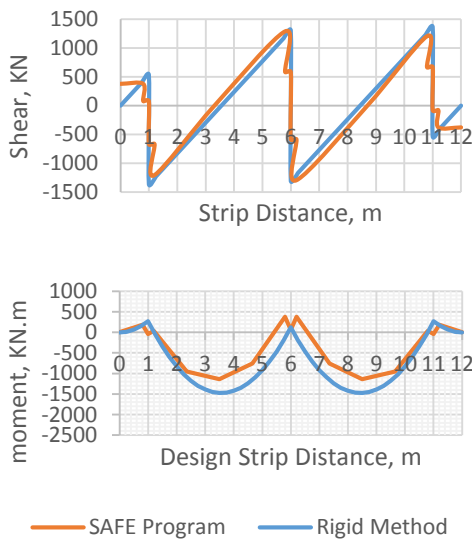

FIGURE 5. One way shear and moments using rigid and SAFE program for Strip ALIG

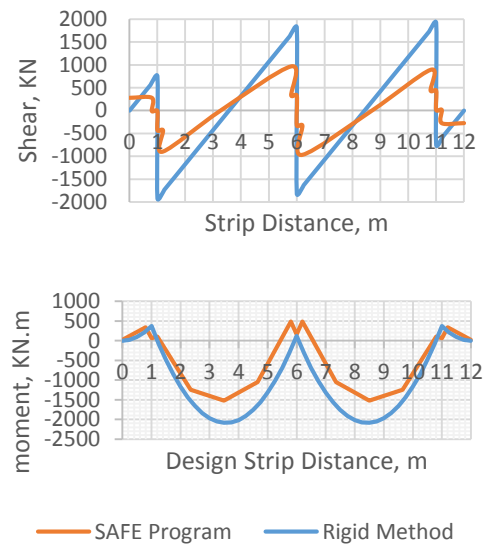
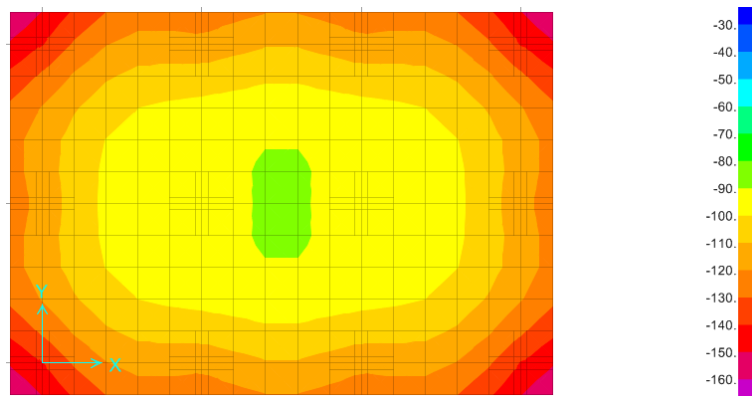

FIGURE 6. One way shear and moments using rigid and SAFE program for Strip LKJI.

With regard to flexural moments in the design strips as shown in Figures 3-6. Overall at middle spans, the rigid method analysis has given the highest amount of negative flexural moments whereas SAFE program has resulted in more positive flexural moments around column faces. Some fluctuations similar to v shape can be seen at column locations in the flexural moments using SAFE program. These fluctuation relates to the stiff area under columns to model column intersection as a stiff slab. Reference to design Strip ABCD, for instance, maximum negative flexural moment (1606 KN.m) have been obtained by rigid method at middle span (8.5m) while an enveloped negative flexural moment (688 KN.m) has been reported using SAFE program at the same distance. On the other hand, under column contact area maximum positive flexural moments of 56 KN.m and 636 KN.m have been gained by both rigid method and SAFE program, respectively.

With regard to contact soil reaction pressure under the mat model, soil pressure produced by service loads was  $109 \text{ KN/m}^2$  uniformed distributed according to the rigid method procedure and it checks allowable bearing capacity ( $120 \text{ KN/m}^2$ ). However, the soil pressures in SAFE program were higher than allowable bearing capacity and especially in the edges and corners of the mat as shown in Figure 7.

These differences belongs to the flexibility of the mat which is reflected in SAFE program. Consequently, SAFE program can be considered as a tool in the evaluation of soil pressure capacity.



Note; Soil pressure are in  $\text{KN/m}^2$

FIGURE 7. Soil pressure under the mat in SAFE program

Punching shear often controls the critical thickness of the mat. In rigid method it can be calculated according to ACI 318-08 (Section 11.12.2.1) for the critical section at interior column and minimum required thickness is equal to 690mm. On the other hand, the foundation mat model needed more thickness to check punching shear ratio ( $V_u/V_c$ ) in SAFE program as shown in Table 3.

TABLE 3.  
Punching shear ratio vs thickness in SAFE program

Columns	Mat thickness in SAFE ,mm					
	600	625	650	675	690	700
Interior	1.2874	1.1965	1.1150	1.0416	1.001	0.9753
Edge	0.9492	0.8849	0.8270	0.7748	0.7459	0.7275
Corner	0.6737	0.6350	0.6252	0.6151	0.6088	0.6046

The punching shear ratio is calculated based on dividing maximum applied shear stress ( $V_u$ ) by maximum concrete shear stress capacity ( $V_c$ ), and less than one is accepted. Bringing punching ratio below one can be obtained by an adequate increase in mat thickness or compressive strength of concrete ( $f_c'$ ).

In addition, an increase in modulus of subgrade reaction  $K_s$  could have a negligible effect on punching ratio.  $K_s$  were increased from (6,000 to 44,000)  $\text{KN/m}^3$  and it was revealed that punching ratio slightly increased but it is insignificant value. This is because of symmetrically distributed of column loads and applied punching loads depending significantly on applied shear stress ( $V_u$ ) produced by the concentrated column loads.

## 6. CONCLUSION

This paper has presented the comparison of mat foundation design using rigid method and SAFE program through the use of the foundation modelling. Mat foundation models are analyzed as rigid body using the conventional rigid method and then SAFE v12 based on finite element method is applied to analyze and design the equivalent models, and the main focus was to investigate the results obtained from both methods.

In discussing analysis results, one way shear and flexural moments of design strip have been drawn for both methods and their differences have been shown that maximum positive and negative shear and moments of rigid method are greater than those of SAFE programs. Furthermore, SAFE program has given more flexural moments around columns, less flexural moments at strip mid span and thicker mat compared to corresponding results obtained in the rigid method. The author thinks that computer software application helps civil engineers to save time and solve complex cases efficiently, but civil engineers needs to use these programs carefully with understanding of modulus of soil subgrade reaction ( $K_s$ ) and basic input parameters used in SAFE program.

## REFERENCES

- [1] ACI 336 “*Suggested analysis and design for combined footings and mats*” Report ACI 336.2R-88, American Concrete Institute, 1988, 20 pp.
- [2] J. E. Bowles, *Foundation Analysis and Design*, 5th ed. International Edition, New York: McGraw-Hill, 1997.
- [3] B. M. Das, "Chapter 6 Mat Foundations" in *Principles of Foundation Engineering, SI*, 7th ed., PWS Engineering: Massachusetts, USA. 2011, pp291-323.
- [4] R. Klemencic, I. S. McFarlane, N. M. Hawkins, and, S. Nikolaou, *Seismic design of reinforced concrete mat foundations: A guide for practicing engineers*, NEHRP: Gaithersburg, 2012
- [5] S. Shihada, J. Hamad, and M. Alshorafa “Suggested Modifications of the Conventional Rigid Method for Mat Foundation Design” in *International Journal of Emerging Technology and Advanced Engineering*, Website: [www.ijetae.com](http://www.ijetae.com) ,ISSN 2250-2459, Volume 2, Issue 4, April 2012.
- [6] ASCE 7-10 *Minimum design loads for buildings and other structures*, American Society of Civil Engineers, Reston, VA, 2010
- [7] ACI 318, *ACI Standard Building Code Requirements for Reinforced Concrete*, ACI 318–08, Farmington Hills, MI, 2008
- [8] S. A. Naeini, R. Ziaie Moayed, F. Allahyari “Subgrade Reaction Modulus (Ks) of Clayey Soils Based on Field Tests” in *Journal of Engineering Geology*: Tehran, Vol.8, No.1, Spring 2014.
- [9] E. Winkler "*Die Lehre von Elastizitat und Festigkeit (on elasticity and fixity)*", Dominicus,Prague, 1867.
- [10] Computer and Structures, Inc. SAFE v12.2, Copyright 1978-2012, Berkeley: California, USA, 2012.

## Assessment of Vertical Pile Capacity in Soil with Weak Layers and Cavities

Ahmed A. Al-Obaidi<sup>1</sup>, Pinar N. Mahmood<sup>2</sup> and Ansam A. Al-Karawi<sup>3</sup>

<sup>1&2</sup> Civil Engineering Dept., Tikrit University, Tikrit , Iraq

<sup>3</sup>Civil Engineering Dept., Diyala , Iraq

<sup>1</sup>civileng88\_2010@yahoo.com, <sup>2</sup>pinar\_civil@yahoo.com, <sup>3</sup>dr.ahmed64@gmail.com

### ABSTRACT

This research is concerned to analyze the behavior of the pile under axial load and to find the ultimate pile capacity regards to present of weak soil layer and cavity using (Plaxis-2D) as a finite element method. The soils and pile is modeled as Mohr-Coulomb and linear elastic non-porous respectively by using axi-symmetric model. 15-node triangle element used to model and interface elements is defined by five pairs of nodes. A total of 37 cases is studied, the first group included piles embedded in dense sand with layer of weak soil ( $\phi = 25^\circ$  and  $30^\circ$ ) at different thickness and locations (24 cases), while the second group included 12 cases for existing of cavity with different diameters and locations. The ultimate capacity of the pile for the above cases are compared with pile embedded in dense soil, (1 case). The results obtained from numerical work are compared with those obtained by analytic Berezantsev method and a good agreement has been found. The results indicated that existing of weak soil layer within the surrounding soil around the pile decreases the ultimate pile capacity. This reduction depends on thickness, and depth of the weak layer. The ultimate capacity ratio for the pile decreases as the depth of the weak soil layer increased along the pile shaft. The minimum values was found when the weak soil layer located near pile tip. Also, the ultimate capacity of the pile decreases as the thickness of the weak soil layer increased. The variation between the ultimate capacity ratios with weak soil layer thickness seems to be liner, for all cases for weak soil layer properties. Presented of cavity reduced the ultimate capacity ratio for the pile, the most dangerous situation when the cavity located near the pile base. At this condition the ultimate pile capacity ratio range between (0.8873 – 0.8101).

**Keywords:** Deep Foundation, Plaxis-2D, F.E.M., Weak Soils, and Cavity.

### 1. INTRODUCTION

Piles are structural members of timber, concrete, and / or steel that are used to transmit surface loads to lower levels in the soil mass, [1]. Piles are generally used to increase the load carrying capacity of the foundation and to reduce the settlement of the foundation. These purposes are accomplished by transferring loads through a soft stratum to a stiffer stratum at a greater depth, or by distributing loads through the stratum by friction along the pile shaft, or by some combination of the two, [2].

The maximum settlement of the pile and its ultimate load bearing capacity are the governing criterion in the design of vertically loaded piles. These are evaluated by carrying out a number of theoretical and numerical approaches. There are many cases in practice where piles pass through different layers of soil that contain softy loose or weak layers of soils, located at different depths and locations. The soil



stratification of many areas consists of different soil and weak layers sometime cavities with different shape, size and depth, as shown in Figure. (1) Respectively for Haditha city. [3] Investigated the load-displacement behavior of axially loaded pile in sandy soil using the finite element program ANSYS (5.4). They made a comparison between the results of F.E.A and laboratory test results which found to be quite close. The analysis of the trial results of the dry models by [4] indicate that the model tests for very deep or shallow cavity with negative distance ratio ( the horizontal distance from the centerline of the pile to the centerline of the cavity  $S/B=-8$ ) carries more load than the cavity case with positive distance ratio. Different failure modes can be observed for each model tests depending upon the geometry of the problem. The pile with vertical dead load of (228.6N) carries more lateral load than pile with no vertical load for the same cavity condition. This behavior is reversed for soil without cavity. In spite of that the constant lateral load is greater than the ultimate lateral resistance of the case ( $F.S=0.8$ ) during the observations of the lateral displacement with time, failure does not occur for cavity condition with ( $D/L=0.5$  and  $S/B=-8$ ), where  $D$  =Depth of the cavity. [5] Found that the agreement between numerical results of end bearing resistance of drilled shafts and available experimental and empirical relations is satisfactory. It can be concluded that the elastoplastic Mohr–Coulomb constitutive law with stress dependent elastic parameters is suitable for numerical modeling of end bearing capacity of drilled shafts in sand also in sandy soils, with increase in the pile embedment depth, the end bearing capacity increases with a decreasing rate. The Numerical analyses show that at the pile tip displacement equal to 5% of pile diameter, the end bearing capacity of drilled shafts with different diameters are approximately equal. This means that the end bearing capacity is less dependent on the changes in drilled shaft diameter provided the associated tip displacement is equal to 5% pile diameter. [6] Carried out a laboratory testing to study the performance of a laterally loaded pile embedded in a soil which contains cavities. The results indicate that the number of cavities and their locations have a combined effect on the behavior of the laterally loaded pile. The existence of a cavity in front and in touch with a pile face causes a decrease in working load as long as it is located in the upper two-thirds of the pile length. Also a cavity that exists in the back and in touch with the pile face causes a decrease in working load as long as it is located in the lower one-third of pile length. The reduction in pile capacity increases as long as the existence of cavities in front of a pile is closer to the pile face and near to the soil surface. The effect of cavities located in front of the pile is marginal at  $X/D>8$ , where  $X$  is the spacing between the cavity and the pile and  $D$  is the diameter of the pile. [7] Considered that one option is to support structures on deep foundations (piles) which penetrate through the weak/ compressible soils. Even when deep foundations are employed, however, it is still generally necessary to import fill to raise the grade level above the flooding level. Thus deep foundations must be used in combination with fill placed on the weak/ compressible soils. This is a delicate situation which the geotechnical engineer must recognize.

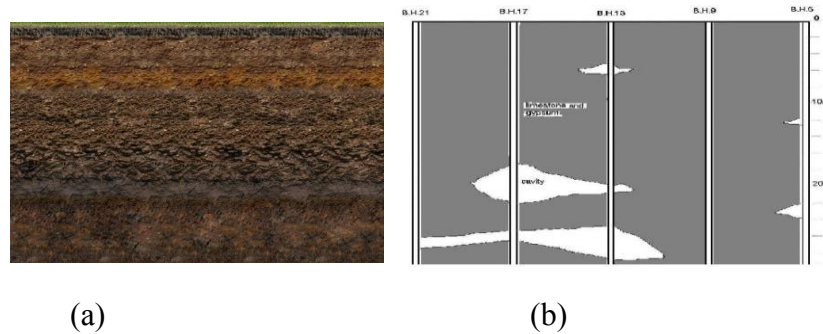

FIGURE 1. Typical cross section in soil profile with (a) weak layer and (b) cavity

## 2. PREDICTING OF ULTIMATE AXIAL RESISTANCE

The analytical solution for a vertical loaded pile in homogeneous single soil layer has been obtained by a number of authors. The behavior of single pile under axial loading, as far as load distribution and settlement along the pile are concerned, has been analyzed through numerous methods. The can be divided into three main categories according to [8]:

1. Load-transfer methods, which involve a comparison between the pile resistance and the pile movement in several points along its length.
2. Elastic theory-based methods, which employ the equations in Mindl in (1936) for surface loading within a semi-infinite mass.
3. Numerical methods, such as the finite element methods.

The load on the pile is gradually increased from zero at the ground surface. Part of this load will be transmitted by the side friction along the pile and the rest will be transmitted to the base.

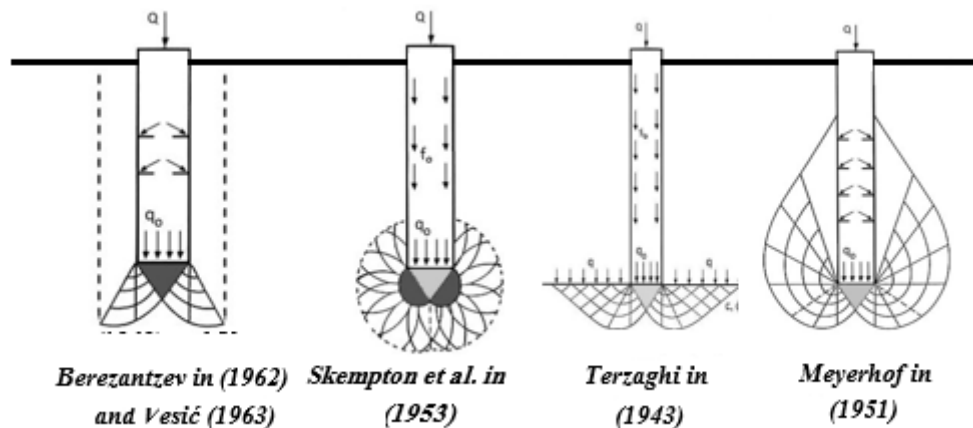

FIGURE 2. The shapes of failure surfaces at the tips of piles as assumed by different Authors, [9]

According to [9] only punching shear failure occurs in deep foundations to attach importance to the density of the soil so long as the depth-width ratio  $L/d$  is greater than 4 where  $L$ = length of pile and  $d$  = diameter (or width of pile), the failure surfaces do not revert back to the shaft.

$$Q_u = Q_b + Q_f = q'_0 N_q A_b + P \int_0^L q''_0 K'_s \tan \delta dL \quad (1)$$

Where:  $Q_u$  = Load at failure applied to the pile,  $Q_b$  = base resistance,  $Q_f$  = shaft resistance,  $q'_0$  = effective overburden pressure at the base level of the pile,  $N_q$  = bearing capacity factors which take into account the shape factor,  $A_b$  = bearing area of the base of the pile,  $P$  = circumference,  $q''_0$  = average effective overburden pressure over the embedded depth of the pile,  $K'_s$  = average lateral earth pressure coefficient and  $\delta$  = angle of wall friction.

### 3. GEOMETRY MODELLING IN PLAXIS-2D

In order to find the influence of weak soil and cavity on the ultimate pile capacity, a total of 37 cases are studied, the first case include embedded the pile in dense soil, the second group includes piles embedded in dense sand with layer of weak soil at different properties ( $\phi$ ), thickness ( $h$ ) and depths from the ground ( $y$ ) (24 cases). While the third group includes 12 cases for existing of cavity with different diameters ( $d$ ) and depths from the ground ( $y$ ). The cross section of the geometry uses in this study was designed as axisymmetric model and according to [10] the boundary conditions recommended at least  $5D$  in the lateral direction, and  $(L+5D)$  in vertical direction where  $D$  and  $L$  are the diameter and length of piles respectively. Details of these cases and the boundary conditions are shown in Figure 3.

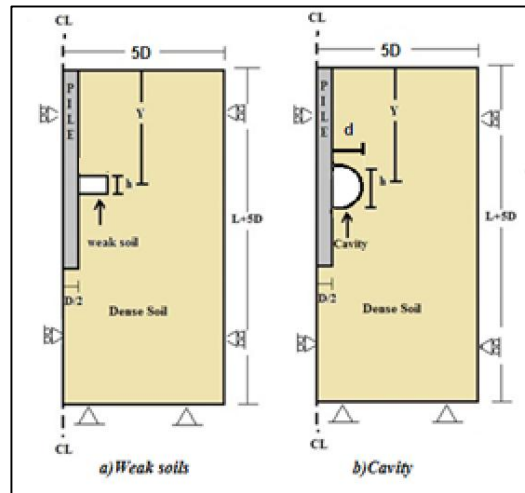

FIGURE 3. Boundary condition model with existing a) Weak soils, b) Cavity

Experiments of [11] have indicated that  $L_c$  (critical length) is a function of friction angles ( $\phi$ ) and pile diameter ( $d$ ). The  $L/d$  ratio as a function of  $\phi$  and may be expressed as follows, [8]

$$\text{For } 28^\circ < \phi < 36.5^\circ \quad L/d = 5 + 0.24(\phi - 28^\circ) \quad (2)$$

$$\text{For } 36.5^\circ < \phi < 42^\circ \quad L/d = 7 + 2.35(\phi - 36.5^\circ) \quad (3)$$

According to the above eq. the piles with diameter equal to 0.5m and length equal to 8m modeled and installed in dense soil with ( $\phi = 40^\circ$ ) are chosen. This pile is subject to uniform axial loading.

In this study, the soil was modeled as Mohr-Coulomb and the pile modeled as linear elastic non-porous. Table.2 Show the soils and piles properties used in this study.

The 15-node element was chosen and medium global coarseness with around 328 elements in order to have a balance between accuracy and calculation time. The mesh was refined around the pile to be more accurate, where major variations of deformations and stresses are expected, [10] In the present study, a failure load defined as that which causes a settlement equal to 10 percent of the pile diameter.

TABLE 1.  
Soil and pile properties

Soil properties	Dense soil	Weak soil		Pile
		1	2	
Modulus of elasticity, E kN/m <sup>2</sup>	80000	37500	23500	30000000
Unit weight, $\gamma$ kN/m <sup>3</sup>	18	16	15	25
Poisson's ratio, $\mu$	0.35	0.3	0.3	0.2
Internal friction, $\phi$ degree	40	30	25	-
Cohesion, c kN/m <sup>2</sup>	1.0	1.0	1.0	-
Angle of Dilatancy, $\psi$ degree	10	0	0	-
Interface reduction factor, R <sub>inter</sub>	1.0	1.0	1.0	-

#### 4. RESULTS AND DISCURSIONS

• **Effect of weak soil Layer Depth, thickness, and soil Properties on the ultimate pile capacity:** Four depths of a single weak soil along the pile are chosen, the center of each layer (y), thickness (h), and soil properties ( $\phi$ ) are shown in Table 2. In all cases the first weak layer case was at the top of the soil and the last one was near the pile tip. The relationship between depth of weak layer center and ultimate capacity ratio (UCR) of the pile is shown in Figure (4) and (5), the ultimate capacity ratio of the pile is defined as the ratio of ultimate capacity of pile penetrate weak soil layer at any depth along the pile shaft to ultimate capacity of pile embedded in dense soil ( $\phi = 40^\circ$ ). From these figures it can be notice that existing of weak soil layer at any depth reduces the ultimate capacity ratio, this reduction increased as the depth of the weak layer center increased and for the two weak soil layer properties. Many researches considered that the load transferred from the pile increased with depth, thus existing of weak layer at deeper layer reduces the ultimate pile capacity. This behavior clarified the reduction of UCR as depth of weak soil layer increased along the pile shaft.

TABLE 2.  
Location and properties of weak soil layer

Thickness of weak layer (m)	Distance from the top to the center of the layer (m)				$\phi$
	0.25	2.25	4.25	7.25	
0.5	0.25	2.25	4.25	7.25	25°
					30°
0.75	0.375	2.25	4.25	7.125	25°
					30°
1.0	0.5	2.25	4.25	7.00	25°
					30°

The ultimate pile capacity for the cases are shown in Table. 3, also these results are compared with theoretical values obtained from Berezantsev method in 1961. The results from numerical analysis give higher values in ultimate capacity than

theoretical analysis; the range is between (1.25 – 2.39) percent. From Table.3, the ultimate capacity of the pile decreases as the thickness of the weak soil layer increased. The variation between the ultimate capacity ratios (UCR) with weak soil layer thickness seems to be liner, as shown in Figure.6 and 7for weak soil layer with angle of internal friction equal to ( $\phi = 25^\circ$ ) and ( $\phi = 30^\circ$ ) respectively at depth of 2.25m and 4.25m.

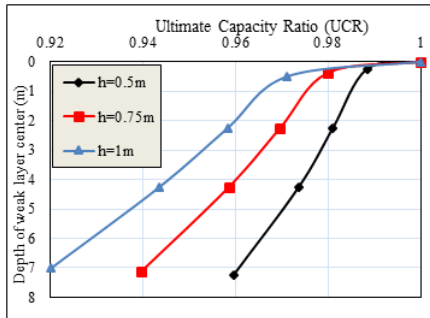

FIGURE 4. UCR versus depth of weak soil layer with ( $\phi = 25^\circ$ ) and for different weak layer thickness

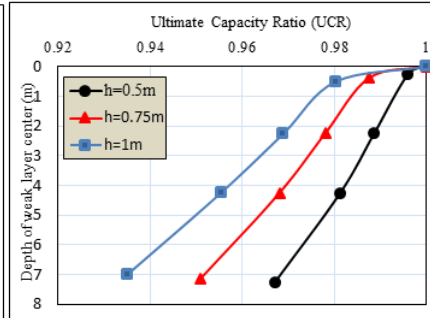

FIGURE 5. UCR versus depth of weak soil layer with ( $\phi = 30^\circ$ ) and for different weak layer thickness

TABLE 3.

Ultimate pile capacity from finite method analysis and theoretical methods

Thickness of weak layer (m)	Depth of layer center (m)	Ultimate capacity from (kN)			
		Plaxis 2D	Berezantsev method in 1961	Plaxis 2D	Berezantsev method in 1961
No weak layer	-	2641.8	2612.86	2641.8	2612.86
		Properties of weak soil layer			
		$\phi = 25^\circ$		$\phi = 30^\circ$	
0.50	0.25	2611.25	2571.25	2631.25	2584.34
	2.25	2591.81	2551.81	2611.81	2565.38
	4.25	2572.36	2532.36	2592.36	2546.41
	7.25	2535.00	2503.20	2555.00	2517.98
0.75	0.375	2589.02	2549.02	2609.02	2549.63
	2.25	2561.68	2521.68	2583.68	2525.89
	4.25	2532.52	2492.52	2557.52	2500.58
	7.13	2482.39	2450.59	2512.39	2464.19
1.00	0.5	2565.85	2525.85	2589.85	2526.92
	2.25	2531.82	2491.82	2559.82	2497.39
	4.25	2492.94	2452.94	2523.94	2463.63
	7.00	2431.27	2399.47	2470.27	2417.22

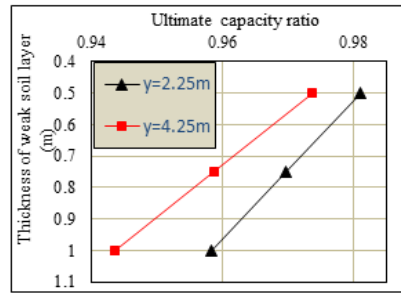

FIGURE 6. UCR versus thickness of weak soil layer with ( $\phi = 25^\circ$ ) for depths

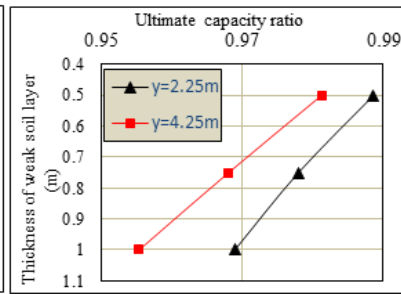

FIGURE 7. UCR versus thickness of weak soil layer with ( $\phi = 30^\circ$ ) for depths

• **Effect of Existing of Cavity on Ultimate Pile Capacity:** Figure 8. show the effect of existing cavity on the ultimate pile capacity. In this figure, the curves show same trend in behavior as existing of weak soil layer but the values are less. In this figure, as the cavity depth increased the ultimate capacity ratio decreases, also the ultimate capacity decreased as the cavity thickness increases. The pile capacity was found to be minimum when the cavity located near the pile base as shown in Table.4. The minimum values of ultimate pile capacity ratio range between (0.8873 – 0.8101). These values less than values for the case of existing of weak soil layer at the same depth and thickness.

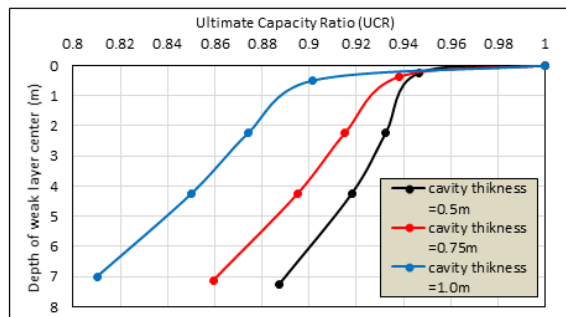

FIGURE 8. Effect of existing cavity with different thickness and depth on the U.C.R

TABLE 4.  
Ultimate capacity for piles with cavity in soil at different depths and thickness.

Thickness of cavity (m)	Depth of cavity (m)	Ultimate capacity (kN)
No weak layer	-	2641.8
0.50	0.25	2500
	2.25	2463
	4.25	2425
	7.25	2344
0.75	0.375	2478
	2.25	2417
	4.25	2364
	7.125	2270
1.00	0.5	2381
	2.25	2308
	4.25	2245
	7.00	2140

## 5. CONCLUSION

Based on the main results obtained from non-linear analysis using 2D-Plaxis in this research, the following conclusions are drawn: The behavior of pile subjected to axial load in soil with weak layer can be modeled using the finite element program (Plaxis 2D). Existing of weak soil layer within the surrounding soil around the pile decreases the ultimate pile capacity. This amount of reduction depends on thickness and depth of weak soil layer. The ultimate capacity ratio for the pile decreases as the depth of the weak soil layer increased along the pile shaft. The minimum values was found when the weak soil layer located near pile tip. The ultimate capacity of the pile decreases as the thickness of the weak soil layer increased. The variation between the ultimate capacity ratios (UCR) with weak soil layer thickness seems to be liner, for all cases for weak soil layer properties. Lower angle of internal friction means extra reduction in the ultimate capacity ratio.

Existing of cavity reduced the ultimate capacity ratio for the pile, the most dangerous situation when the cavity located near the pile base. At this condition the ultimate pile capacity range between (0.8873 – 0.8101).

## REFERENCE

- [1] J. E. Bowles, *Foundation analysis and design*, 5th. ed. Singapore: McGraw-Hill, 1996.
- [2] [2] L.C. Reese, W.M. Isenhower, and S. Wang, *analysis and design of shallow and deep foundations*, New Jersey: John Wiley and Sons, 2006.
- [3] G. E. Abdelrahman, and A. F. Elragi, "Three-dimensional analysis of single pile in sand using drager-prager model," M.Sc dissertation, Cairo University, Fayoum Branch, Egypt, 1997.
- [4] K. T. Shalash, R. M. Mahmoud and L. J. Aziz, "Lateral resistance of a single pile embedded in sand with cavities," *Eng. & Tech*, vol. 30, No.15, 2012.
- [5] G. I. Ahmadi and S. M. Khabbazian, "End bearing capacity of drilled shafts in sand: A Numerical Approach," *Geotechnical and Geological Engineering*, vol. 04, No. 27(2), pp. 195-206, 2008.
- [6] S. M. Al-Taie, "Performance of laterally loaded piles embedded in sandy soils with cavities," M.Sc. dissertation, University of Baghdad, Iraq, 2004.
- [7] C. C. Swan (2007) "Foundations on Weak and/or Compressible Soils" *Foundations of Structures Supplemental Notes: Foundations on Weak and Compressible Soils*, 2007.
- [8] H. G. Poulos, and E.H. Davis, *Pile foundation analysis and design*: John Wiley and Sons, Australia, 1980.
- [9] A. S. Vesic, "A study of bearing capacity of deep foundations," Final Report, School of Civil Eng., Georgia Inst. Tech., Atlanta, U.S.A, 1967.
- [10] B. P. Naveen, T.G. Sitharam and S. Vishruth, "Numerical simulation of vertically loaded piles," in *Indian Geotechnical Conference*, Kochi, 2011.
- [11] A. S. Vesic, "Design of pile foundations," National Cooperative Highway Research Program Synthesis of Practice No. 42, Transportation Research Board, Washington, 1977.



## Use of Plastic Waste in Gypseous Soil Reinforcement

Omer Muhie Eldeen Taha<sup>1</sup>, Junaid Kameran Ahmed<sup>2</sup>, Barham Haidar Ali<sup>3</sup>, Mohammed Taraq<sup>4</sup>

<sup>1,2,3,&4</sup> Department of Civil Engineering, Ishik University, Erbil, KRG-Iraq

<sup>1</sup> omer.muhi@ishik.edu.iq, <sup>2</sup> junaid.kameran@ishik.edu.iq, <sup>3</sup> barham.haydar@ishik.edu.iq,

<sup>4</sup> mohammed.taraq@ishik.edu.iq

### ABSTRACT

Increasing the bearing capacity of soils has been a recurring issue for several thousands of years and even till the present time. The attendant problems resulting from dissolving gypsum in gypseous soils in addition to the widespread use of plastic material globally has led to the use of plastic waste for reinforcing the gypseous soils. A series of tests were carried out to evaluate the benefits of utilizing recycled waste plastic bottles in improving the bearing capacity of gypseous soil. The soil is classified as poorly graded sand (SP) according to the Uniform Soil Classification System. There are three forms of soil reinforcement used in this study, non-perforated strips waste plastic, perforated strips waste plastic and irregular pieces of waste plastic. The increase in bearing capacity was more than two times original bearing capacity in dry condition. The bearing capacity of reinforced soil decreased to about 50% after leaching but it is still 1.5 times more than unreinforced soil. Conclusively, the reinforcement of gypseous soils with waste plastic can improve bearing capacity of soils and reduce pollutants in environment.

**Keywords:** Gypseous Soils, Bearing Capacity, Plastic Waste.

### 1. INTRODUCTION

Gypsous soils are wide spread across the global, where found mostly in the arid and semi-dry regions. The estimated area covered by this soil on the universe is about 8500.000 km<sup>2</sup> and in Iraq equal to about 28% of the total area [1]. It is known that this soil causes a lot of problems for the facilities and buildings that are erected on it when exposed to water due to melting or dissolution of gypsum in water, which causes an increase in compression and decrease in shear strength of the soil.

The Solubility of gypsum depends on many factors such as the temperature, stress level, presence of other salts such as NaCl and MgCl<sub>2</sub>, as well as the nature and type of the gypsum. The soluble gypsum may be leached out of the soil profile, when this happens it causes changes in the soil properties [2].

### 2. BACKGROUND

Gypsum, whether in massive or particulate form, dissolves due to water table fluctuation or water infiltration into these soils causing deterioration of foundations, producing cavities and /or progressive settlement of buildings. The dissolution of gypsum is likely to be controlled primarily by the surface area in contact with water and the flow velocity of water associated with unit area of substance, but it would not cause acceleration of seepage flow or foundation deterioration provided that the initial flow rates have been kept to low values [3].

Klien and Hurbut reported that the hydrated calcium sulfate or gypsum ( $\text{CaSO}_4 \cdot 2\text{H}_2\text{O}$ ) is the most wide spread and important hydrous sulfates. The structure of gypsum consists of parallel layers of  $[\text{SO}_2]^{-2}$  groups strongly bonded to  $(\text{Ca})^{+2}$ , successive layers of this type are separated by sheets of  $(\text{H}_2\text{O})$  molecules [4]. According to Alphen and Romero gypseous soils can be define as soils that contain more than 2%, gypsum [5]. While Barzanji, classified the soils according to their gypsum content to six classes as shown in Table (2-1) [1].

TABLE 2.1  
Classification of gypseous soil [1]

Gypsum (%)	Classification
0 – 0.3	Non- gypseous
0.3 – 3.0	Very slightly-gypseous soil
3.0 – 10.0	Slightly- gypseous soil
10.0 – 25.0	Moderate- gypseous soil
25.0 – 50.0	Highly – gypseous soil
>50.0	Gypseous soils to be described by the other fraction such as clayey or sandy gypseous soil

Knight [6] proposed a test called (Double Odometer Collapse Test), to estimate and measure the collapsibility of the gypseous soil. Undisturbed sample of the soil at specified initial water content is cut to fit in the consolidometer ring, and loads are applied progressively in a manner similar to the standard consolidation test until specified soaking pressure (about 200 kPa) is reached. At the end of this loading, the specimen is flooded with water, and is left for 24 hr, and the consolidation test is then carried out to its maximum loading limit. The collapse potential (CP) is then defined as:

$$CP = \frac{\Delta H_e}{H_o} = \frac{\Delta e}{(1+e_o)} \quad (2.1)$$

Where CP is collapse potential,  $\Delta H_e$  is change in heights up on wetting,  $H_o$  is initial height,  $\Delta e$  is the change in void ratio upon wetting, and  $e_o$  is the natural void ratio.

After measuring the collapse potential, the severity of the problem of collapse can be estimated as shown in Table (2.2) [7].

TABLE 2.2  
Collapse potential and severity of problem [7]

Collapse Potential (%)	0-1	1-5	5-10	10-20	>20
Severity of Problem	No Problem	Moderate Trouble	Trouble	Severe Trouble	Very severe Trouble

The idea of reinforcement of the soil is an old one, which has been put into use since the ancient times when human used straw to improve the quality of clay block used in construction works and this phenomenon continues till today in some areas [8].

Consoli et al, evaluated the benefit of utilizing randomly distributed polyethylene terephthalate fiber that were obtained from recycled waste plastic bottles in its simple

form and also when combined with rapid hardening Portland cement to improve the engineering behavior of a uniform fine sand. The results showed that the polyethylene terephthalate fiber reinforcement greatly improved the peak and ultimate strength of both cemented and uncemented soil and in a way reduced the brittleness of the cemented sand. In addition, the initial stiffness was not significantly changed by the inclusion of fibers [9]. In the recent study, a California Bearing Ratio test (CBR) has been conducted on the soil samples reinforced with specific plastic strips. The results show that use of plastic in soil leads to improve the strength of soil [10].

### 3 MATERIALS AND METHODS

#### 3.1 SOIL

The soil used was taken from Tikrit university campus, in Tikrit, Saladin, Iraq. Samples were taken from a depth (1-2) meters below the surface of the Earth. All sample wrapped in nylon bags before they were transferred to the laboratory. Figure (3.1) shows a sample of gypseous soil. Tables (3.1) and (3.2) show the soil properties.

TABLE 3.1  
Chemical Properties of soil

Test	Value
Gypsum Content (%)	45-50
Total Soluble Salts (%)	10.84
Organic Matters Content (%)	3.01
pH	7.45

TABLE 3.2  
Physical properties of soil

Properties	Value
Water Content (%)	8.18
Specific Gravity (Gs)	2.61
Liquid Limit (%)	20
Plastic Limit (%)	-
USCS	SP
Relative Density (%)	65.5
Max. Dry Density (kN/m <sup>3</sup> )	16.0
Min. Dry Density (kN/m <sup>3</sup> )	12.0
Field Dry Density (kN/m <sup>3</sup> )	14.35



FIGURE 3.1 Gypseous soil sample

### 3.2 REINFORCING MATERIALS (PLASTIC WASTE)

A soft drink bottles were collected for the purpose of reinforcing the soil and prepared in two sizes. The first is strips of length (150 - 200) mm, width (15 - 20) mm and thickness (0.85) mm which can either be used in either perforated or non-perforated form. The second size are of small irregular shapes and dimensions.

### 3.3 TEST METHOD

The device used in the bearing capacity test consists of four main parts; Box, foundation, structure loading and loading system Figure 3.2. An iron box with dimensions (900 × 900 × 500) mm filled with compacted soil sample. At the bottom of the box, a valve is positioned to control the discharge of water during the washing process; in addition, a plastic transparent tube of 600mm height is attached (vertically) to the bottom measure water level as well as detects time of saturation. Other components of the box are; a filter made from Geotextile material at the base of the box prevents solid materials from passing during the process of soil washing. A square rigid foundation plate with (100 × 100) mm and (30) mm thickness was used for bearing capacity test. Soil samples were put in the box in layers with 25mm thickness. Each layer was compacted alone by iron hammer until the required density achieved. In dry condition, soil were tested without using water by increasing bearing load until failure, the settlement with corresponding load were measured.

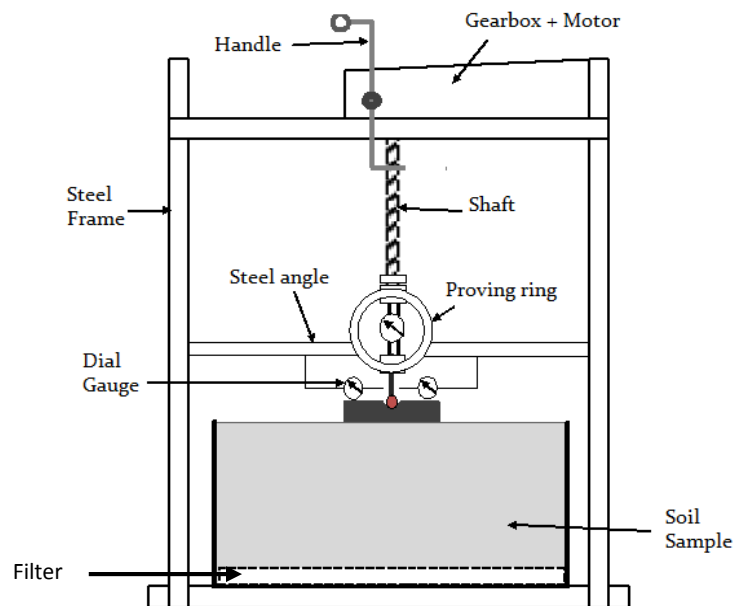

FIGURE 3.2 Sketch for compression machine used for test

In wet condition, initially, the foundation was loaded with 100 kPa pressure in dry condition and settlement reading was taken. Then, the soil was soaked in water. The process of soil inundation with water (Soaking Process) took approximately (48 - 96) hours the settlement was recorded during the test process at different periods by the dial gauge, then washing process (Leaching Process) applied. The washing process was run for 144 hours (six days). At the end of leaching process, the water

supply valve was turned off and the water was drained out, thereafter, the tested completed by increasing the load gradually until the failure.

## 4 RESULTS AND DISCUSSION

### 4.1 BEHAVIOR OF DRY SOIL

Figure (4.1) gives the relationship between the bearing pressure and the drop in millimeters of the unreinforced dry soil with field density and moisture content. From this figure, the relationship is linear only in its early stages and continue nonlinearly until failure. The value of maximum bearing pressure can be identified through the continued decline without any increase in the load. The maximum bearing amount for unreinforced soil was (254 kPa) at a drop of (10.5) mm.

As mentioned previously, three types of reinforcement were used in this work, the first being cut bottles in the form of tapes, the second type is in the form of perforated strips and the third type was randomly cut small pieces of different shapes and sizes. The relationship between stress and settlement of the reinforced soil of these three types are illustrated in Figure (4.2). The behavior of the three types of reinforced soils is similar to the behavior of the unreinforced soil with a difference in the values of bearing capacity and settlement.

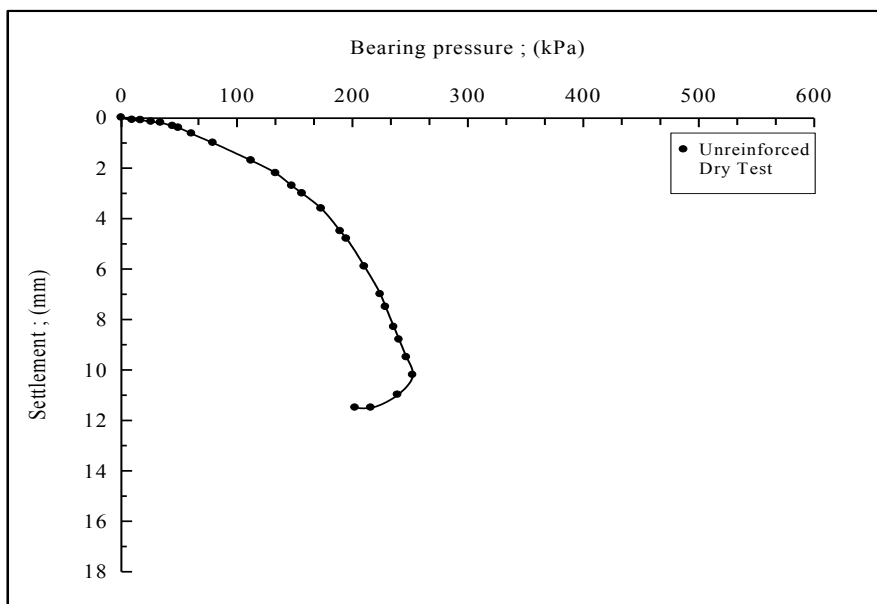

FIGURE 4.1 the relationship between the bearing pressure and the settlement of the unreinforced dry soil

Table 4.1 shows the values of maximum bearing capacity of the unreinforced soil and the reinforced soil with the values of the corresponding final settlement. For the purpose of studying the efficiency of the reinforced soil, the expression ratio of bearing capacity of the soil (which is equal to the value of the maximum stress of the reinforced soil divided by the value of bearing of unreinforced soil) was used. It can be seen from Figure 4.2, bearing capacity of reinforced soil by plastic stripes equal to two times the bear capacity of unreinforced soil. While the bearing capacity of soil reinforced by perforated strips equal to 2.393 times the bearing capacity of unreinforced soil.

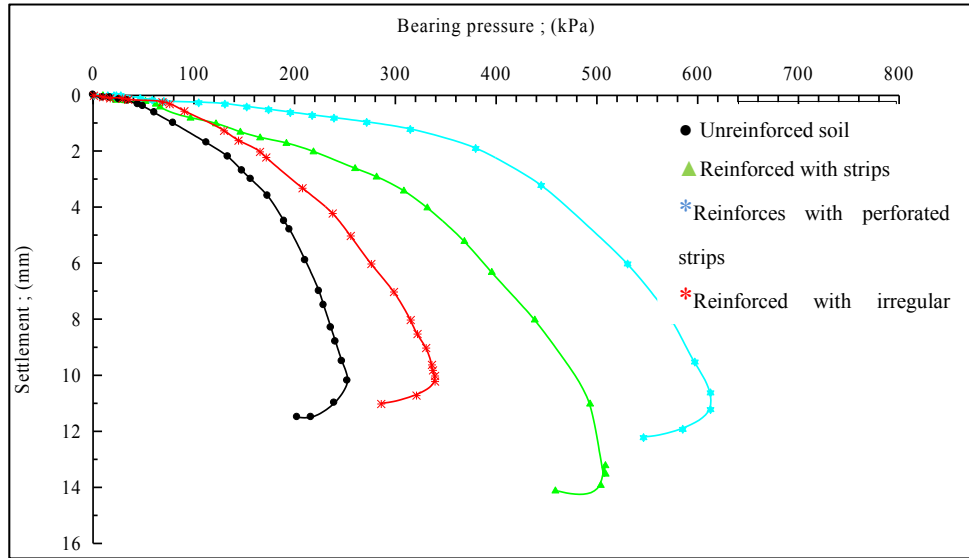

FIGURE 4.2 the relationship between the bearing pressure and the settlement of the reinforced and unreinforced soil in dry case

Previous study showed that the measured bearing capacity (soil using plate load test) of the plastic bag waste reinforced soil higher than unreinforced soil. In addition, the results reveal that as the plastic strip lengths and widths increased, the bearing capacity of the soil also increased [11].

TABLE 4.1  
Values of the bearing capacity and settlement of the soil with and without reinforcement

Type of soil	Bearing capacity of soil (kPa)	Max. Bearing (%)	Settlement (mm)
Unreinforced soil	254	1.000	10.50
Reinforced with strips	504	1.984	13.6
Reinforced with Perforated strips	608	2.393	11.1
Reinforced with plastic pieces	338	1.330	10.9

#### 4.2 BEHAVIOR OF SOIL AFTER SOAKING AND LEACHING

Figure (4.3) shows the relationship between the bearing pressure and the settlement of the reinforced and unreinforced soils.

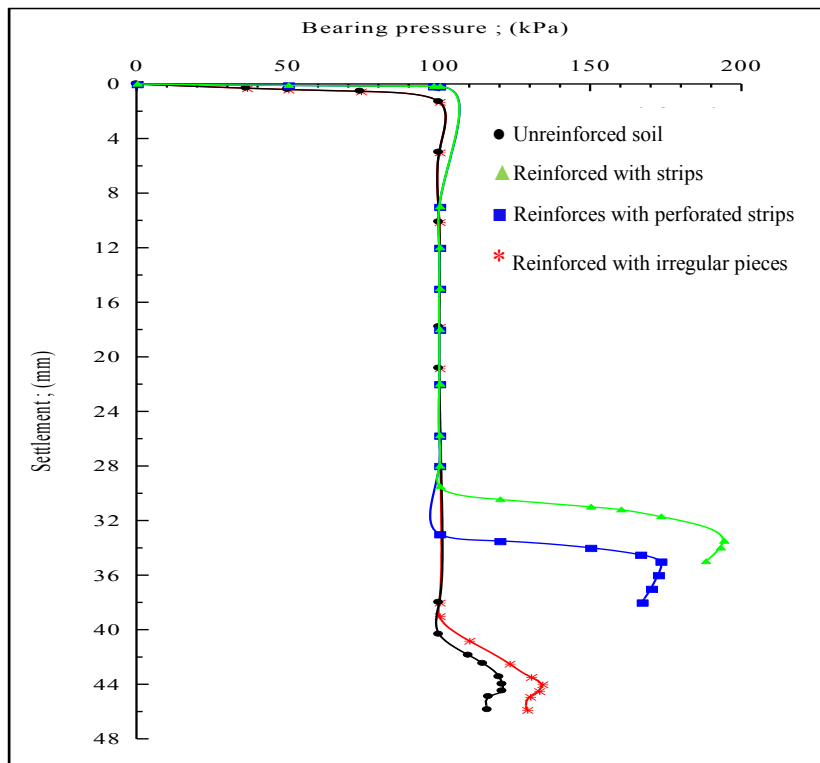

FIGURE 4.3 the relationship between bearing pressure and settlement for reinforced and unreinforced soils after soaking and leaching

It was found that immersion and washing soil with water increase the settlement significantly at constant load of 100 kPa, the value of maximum bearing for the unreinforced soil drop to 117 kPa which is equal to 50% the bearing capacity of unsoaked samples and the value of settlement increased to 44 mm after soaking. It was found also soil failed quickly after increasing the bearing load. However, the bearing pressure of reinforced soil after soaking still higher than in reinforced soil in about 1.5 times.

Table 4.3 shows the amount of improvement in the reinforced soil after soaking and leaching. It is noted that the reinforcing tapes has the best bearing capacity ratio, this is quite different from the dry case and this may be due to the reinforcement preventing the leakage of dissolved gypsum which then reduces the voids and collapsibility of the soil compared to the rest categories of reinforcement. The perforated strips give less bearing capacity due to the holes in tapes, which have contributed to the movement of dissolved gypsum and led to increase in voids. Despite the increase in the bearing capacity of soil during soaking and leaching stages the settlement remained higher, however these values may not fit engineering requirements of structure, but in spite of this, the use of this type of reinforcement, with a very reduced cost implication may contribute to reducing the safety factor to be taken when designing foundations in gypsum soils.

TABLE 4.2  
Values of the bearing capacity and settlement of the soil with and without reinforcement after soaking with water

Type of soil	Soaking Time (hr)	Leaching Time (hr)	Settlement (mm)	Max. Bearing Capacity (kPa)	Total Settlement (mm)
Unreinforced soil	72.0	144.0	35.0	117.0	44.0
Reinforced with strips	138.0	144.0	23.0	192.0	31.
Reinforced with Perforated strips	114.0	144.0	25.0	170.0	35.5
Reinforced with plastic pieces	74.0	144.0	31.0	131.0	43.0

TABLE 4.3  
Values maximum bearing ratio and settlement of the reinforced and unreinforced soil after soaking and leaching

Type of soil	Max. Bearing (%)	Settlement (mm)
Unreinforced soil	1.000	44.0
Reinforced with strips	1.641	31.0
Reinforced with Perforated strips	1.452	35.5
Reinforced with plastic pieces	1.119	43.0

## 5 CONCLUSION

In this study, bearing capacity of gypseous soil were measured before and after plastic waste reinforcement. The results shows that the use of plastic waste improve the bearing capacity of the gypsum soil. The maximum improvement occurred in dry condition, where the perforated plastic waste strips led to increased bearing capacity by 248% while the increase in non-perforated plastic waste strips was 198%. It is also evidenced that reinforcement of the soil by using pieces of waste plastic, causes slight increase in the susceptibility of the soil. Foundation settlement in reinforced and unreinforced soils was insignificant in dry condition while a significant settlement were noted in wet condition. Furthermore, reinforcing the soil with plastic waste can also reduce the settlement in wet condition. Finally, use of plastic waste will also greatly reduce the environmental menace.



## REFERENCES

- [1] A. F. Barzanji, "Gypseous Soil of Iraq", Ph. D. Thesis, State University of Ghent, Belgium, 1973.
- [2] P. Buringh, "Soils and Soil Conditions in Iraq" Ministry of Agriculture Report, Baghdad, Iraq, 1960.
- [3] A.N. James and A.R. Lupton, "Gypsum and Anhydrite in Foundations of Hydraulic Structures", *Geotechnique*, Vol. 28, (3) pp. 249-272, 1978.
- [4] C. Klein, and C. S. Hurbut, "Manual of Mineralogy, After J. D. Dana", 20th Edition, John Wiley and Sons, New York, 1985.
- [5] J. G. V. Alphen and F. D. R. Remero, "Gypseous Soils: Notes on Their Characteristic and Management", International Institute for Land Reclamation and Improvement, Bulletin 12, Wageningen, Netherlands, 1971.
- [6] K. Knight, "The Origin and Occurance of Collapsing Soils", *Proc. 3rd. Regional Conference of Africa on Soil, Mechanics and Engineering*, 1963, pp. 127-130.
- [7] J. E. Jennings and K. Knight, "A Guid To Construction on or with Materials Exhibiting Additional Settlement Due To Collapse of Green Structure", *Proc. Of 6th .Regional Conference of Africa on soil Mechanics and foundation Engineering*, South Africa, 1975, pp.99-105.
- [8] H. A. Alawaji, "Settlement and bearing capacity of geogrid-reinforced sand over collapsible soil" *Journal of Geotextiles and Geomembranes*, vol. 19, pp. 77-88, 2001.
- [9] N.C. Consoli, J.P. Montardo, P.D.M. Prietto, and G.S. Passa, "Engineering Behaviour of a Sand Reinforcement with Plastic Waste" *ASCE Geotechnical and Geoenvironmental Engineering*, vol. 128, (6) pp. 462-472, 2002.
- [10] P. Bhattarai, A.V.A. Bharat Kumar, K. Santosh, T.C. Manikanta, and K. Tejeswini, "Engineering Behavior of Soil Reinforced with Plastic Strips" *International Journal of Civil, Structural, Environmental and Infrastructure Engineering Research and Development (IJCSEIERD)*, vol.3, (2) pp. 83-85, 2013.
- [11] F.C. Chebet and D. Kalumba, "Laboratory Investigation on Re-using Polyethylene (Plastic) Bag Waste Material for Soil Reinforcement in Geotechnical Engineering" *Civil Engineering and Urban Planning: An International Journal (CiVEJ)*, vol. 1, (1) pp. 67-82, 2014.

## The Effect Of Fiber Orientation And Number Of Layer On The Natural Frequency Of Composite Laminated Plate

Junaid Kameran Ahmed<sup>1</sup>, Omer M.E. Taha<sup>2</sup>, Barham Haider<sup>3</sup>,

Mohammed Tareq<sup>4</sup>

<sup>1,2,3&4</sup> Department of Civil Engineering, Ishik University, Erbil, KRG-Iraq  
<sup>1</sup>junaid.kameran@ishik.edu.iq, <sup>2</sup>Omer.muhi@ishik.edu.iq, <sup>3</sup>Barham.haydar@ishik.edu.iq,  
<sup>4</sup>Mohammed.tareq@ishik.edu.iq

### ABSTRACT

A Graphite Epoxy composite plates has been analyzed dynamically in the present work by using a quadratic element (8-node diso parametric) by depending on 1<sup>st</sup> order shear deformation theory, every node in this element has 6-degree of freedom (displacement in x,y and z axis and twist about x ,y and z axis ). The dynamic analysis in the present work covered parametric studies on a composite laminated plate (square plate) to determine its effect on the natural frequency of the plate. The parametric study represented by set of changes (layer number, boundary conditions, layer orientation) the plates have been simulated by using ANSYS package 12. The boundary conditions considered in this study, at all four edge of the plate, are simply supported and clamped boundary condition. The results obtained from ANSYS program shows that the natural frequency for both fixed and simply supported increase with increasing the number of layers, but this increase in the natural frequency for the first five modes will be neglected after 10 layers. And it is observed that the natural frequency of a composite laminated plate will change with the change of ply orientation, the natural frequency increase and it will be at maximum with angle 45 of ply for simply supported laminated plate, and maximum natural frequency will be with cross ply (0 / 90) for fixed laminated composite plate.

**Keywords:** laminated plate, orthotropic plate, square plate, (free vibration) natural frequency, Composite (graphite/ epoxy).

### 1. INTRODUCTION

Technological progress results in the continuous expansion of structural material types and in an improvement of their properties. The most frequently used structural materials can be categorized in four primary groups: metals, polymers, composites, and ceramics. One of the clearest manifestations of such an interrelated process is the development and application of composite materials. The needs of the aerospace industry and high raise building drive to the use and improvement of composite materials [1]. The progress in the industrialization process and technology of composites materials has improved the use of the composites from secondary structural components to such a primary component. Through the last decade plates made by composite materials are being progressively used in many engineering purpose. The high stiffness/weight ratio coupled with the flexibility of the chosen of the lamination sketch which can be sewed to match the design demand makes the laminated plate an interesting structural component for many manufactures. The grown use of laminated plates in different areas has encouraged the use of plates as a

constructional element for the present research. The results of the analysis of natural frequency for the laminated composite plates in the structural designing are so remarkable to avoid the resonant action of the laminated structures, whether the use of composite materials are in civil, aerospace, and marine they are applied to dynamic loads.

## 2. REVIEW OF LITERATURE

The natural frequencies and mode shapes of a number of Graphite/ Epoxy and Graphite/Epoxy-Aluminum plates and shells were experimentally determined by Crawly. Natural frequency and mode shape results compared with finite element method [2].

Kim and Gupta (1990) investigated the effects of lamination and extension–bending coupling, shear and twist-curvature couplings on the lowest frequencies and corresponding mode shapes for free vibration of laminated anisotropic composite plates using a finite element method with quadratic interpolation functions and five degrees of freedom (DOF).

Narita and Leissa (1991) presented an analytical approach and accurate numerical results for the free vibration of cantilevered, symmetrically laminated rectangular plates. The natural frequencies are calculated for a wide range of parameters: e.g., composite material constants, fiber angles and stacking sequences.

Qatu and Leissa (1991) analyzed free vibrations of thin cantilevered laminated plates and shallow shells by Ritz method. Convergence studies are made for spherical circular cylindrical, hyperbolic, paraboloidal shallow shells and for plates. Results are compared with experimental value and FEM. The effect of various parameters (material number of layers, fiber orientation, curvature) upon the frequencies is studied.

Koo and Lee (1993) used a finite element method based on the shear deformable plate theory to investigate the effects of transverse shear deformation on the modal loss factors as well as the natural frequencies of composite laminated plates. The complex modules of an orthotropic lamina were employed to model damping effect.

Rikards (1993) presented a sandwich composite beam and plate finite super elements with viscoelastic layers for vibration and damping analysis of laminated composite beams or plates. Each layer was considered as simply Timoshenko's beam or Mindlin-Reissner plate finite element.

Rosce and Lu (1993) have determined the vibrational characteristics of a glass reinforced composite cylindrical shell experimentally and evaluated. An impedance test was conducted to study the effectiveness of damping and vibration related properties of the composite.

Soares, Pedersen and Araujo (1993) described an indirect identification technique to predict the mechanical properties of composites which makes use of eigen frequencies, experimental analysis of a composite plate specimen, corresponding numerical-eigen value analysis and optimization techniques.

## 3. MATERIAL & METHODOLOGY COMPOSITE MATERIALS

A composite material can be defined as a combination of a matrix and a reinforcement, which when combined gives properties superior to the properties of the individual components. In the case of a composite, the reinforcement is the fibres and is used to fortify the matrix in terms of strength and stiffness [3].

A reinforcement material called fiber and a base material called matrix to achieve better engineering properties than the conventional material. Composite materials are ideal for structures that require high strength to weight and stiffness to weight ratios. The positive characteristic of using composite material is the control capability of fiber alignment by changing the fiber orientation and layers according to the required properties (strength and stiffness).

For the present study it has been considered a square orthotropic plate consists of graphite/epoxy material accumulate series considered for the laminates is  $[\Theta/\Theta]$ , with change of  $\Theta$ . The symmetry angle-ply composite plate is simulated for various stacking series for two boundary conditions, simply supported and fixed has been considered. Detail of the plate : Length = 1m, width = 1m, thickness = 0.01 m, stacking sequence angle (0,15,30,45,60,75,90), Layer number =(2,4,6,8,10,12,14,16) ply, material properties are:

$E_1 = 175 \text{ e9 N/m}^2$ ,  $E_2 = 7 \text{ e9 N/m}^2$ ,  $E_3 = 7 \text{ e9 N/m}^2$  ,  $\nu_{12} = \nu_{13} = 0.25$   
 $\nu_{23} = 0.01$ ,  $G_{12} = G_{13} = 3.5 \text{ e9 N/m}^2$  ,  $G_{23} = 1.4 \text{ e9 N/m}^2$   
 Unit weight= 1550 kg/m<sup>3</sup>

### 3.1 FREE VIBRATION

Means the movement of a structure without any exterior powers(dynamic force)or reaction motion. The linear(SDF)systems motion without damping can be specializes

$$m \frac{d^2 u}{dt^2} + ku = 0 \quad \text{----- (1)}$$

Free vibration is initiated by disturbing the system from its static equilibrium position by imparting the mass some displacement  $u(0)$  and velocity  $\dot{u}(0)$  at time zero, defined as the instant the motion is initiated

$$u = u(0), \dot{u} = \dot{u}(0)$$

So, solution to the equation is obtained by standard methods:

$$u(t) = u(0)\cos \omega_n t + \frac{\dot{u}(0)}{\omega_n} \sin \omega_n t \quad \text{----- (2)}$$

Where natural circular frequency of vibration in unit radians per second=

$$\omega_n = \sqrt{\frac{k}{m}} \quad \text{----- (3)}$$

The time required for the undamped system to complete one cycle of free vibration is the natural period of vibration of the system. Natural cyclic frequency of

$$T_n = \frac{2\pi}{\omega_n} \quad \text{----- (4)}$$

vibration is denoted by  $F_n = 1/T_n$  , unit in Hz (cycles per second)

### 3.2 MODE SHAPE

Introducing the Eigen value problem whose solution gives the natural frequencies and modes of a system. The free vibration un damped system in one of its natural vibration modes can be described by

$$u(t) = q_n(t)\phi_n \text{ ----- (5)}$$

Where,  $\Phi_n$  does not vary with time.

The time variation of the displacements is described by the simply harmonic function

$$q_n(t) = A_n \cos \omega_n t + B_n \sin \omega_n t \text{ ----- (6)}$$

An, Bn are constants of integration.

Combining above two equations

$$u(t) = \phi_n (A_n \cos \omega_n t + B_n \sin \omega_n t) \text{ ----- (7)}$$

Putting in equation of un damped free vibration

$$[-\omega_n^2 m \phi_n + k \phi_n] q_n(t) = 0 \text{ ----- (8)}$$

Either,  $q_n(t) = 0, \Rightarrow u(t) = 0$ , trivial solution

Or,  $k \phi_n = \omega_n^2 m \phi_n$

This is called matrix Eigen value problem.

This equation can be written as

$$[k - \omega_n^2 m] \phi_n = 0 \text{ ----- (9)}$$

A set of “n” homogeneous algebraic equation is for that “n” no of element. This set has always the trivial solution  $\phi_n=0$ , it implies no motion. The nontrivial solution is:

$$\det [k - \omega_n^2 m] = 0, \text{ This is called frequency equation.}$$

### 3.3 ANSYS MODELING

By using ANSYS 12.0 package the dynamic analysis have been done. For layered applications of a structural shell model the element SHELL99 can be used. So the element SHELL99 linear layer used to model the laminated composite plates. SHELL99 go ahead up to two hundred fifty layers. This element has 6-degrees of freedom in every node: displacement in the x, y, and z directions and twist about the nodal x, y, and z axes.

### 4. RESULTS AND DISCUSSION

The natural frequency of laminated composite plates is investigated for various numbers of layers, and stacking sequences (with the same thickness) in the laminated composite plates. Couples of cases for boundary conditions were analyzed (simply supported and fixed). The cases investigated during the present study are defined below.

**4.1 Case 1:** A composite laminated plate consisted of graphite/epoxy material for tow boundary conditions simply supported and fixed have been investigated for the current study. In this problem the natural frequency has been studied for various numbers of layers for the composite plate for the same thickness.

TABLE 1.

Natural frequency of a fixed symmetry angle-ply [45 / 45-]s square composite laminated plate

Natural Frequency					
No. of layer	mode1	mode2	mode3	mode4	mode5
2	67.05	134.58	134.58	211.51	232.25
4	99.65	176.11	219.21	268.91	334.75
6	104.95	195.73	222.04	308.11	355.21
8	106.11	201.25	221.3	319.33	359.48
10	106.81	204.85	220.69	326.39	362.22
12	107.1	206.75	219.98	330.06	363.27
14	107.32	208.18	219.51	332.65	364.15
16	107.44	209.13	219.01	334.32	364.55

It is observed from the table above that the increasing in layer numbers for the same thickness of the plate with the same case of boundary condition which is fixed, increase the Natural Frequency clearly, but this increase in Natural Frequency will be ignored after rising layer numbers more than 10 for the same thickness, so it can deduced from that the maximum natural frequency for this plate by using 10 layer for symmetric fixed composite laminated plate. The effects of number of layer in the laminate are clearly shown Fig. 1

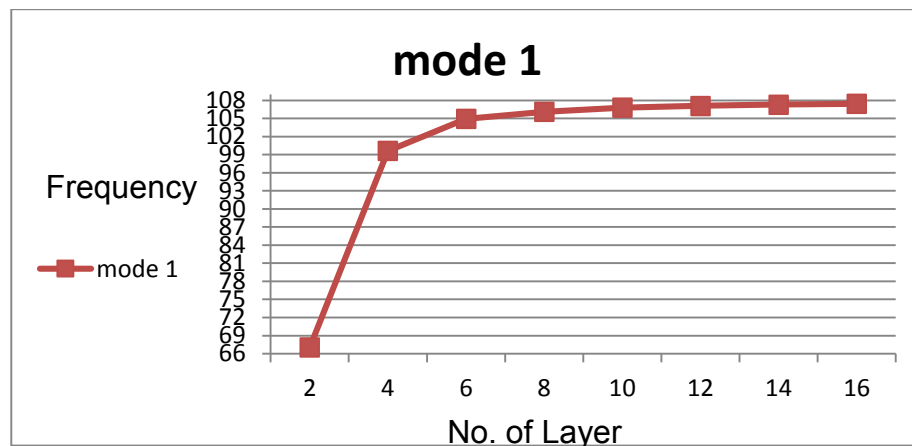

FIGURE 1. Natural frequency (first mode shape) of fixed composite laminated plate with various numbers of layers

TABLE 2.  
Natural frequency of a symmetry angle-ply [-45 / 45] s simply supported square laminated composite plate

Natural Frequency					
No. of layer	mode1	mode2	mode3	mode4	mode5
2	51.25	105.79	105.79	179.26	181.48
4	59.83	129.88	157.82	199.19	256.5
6	64.73	137.35	160.64	234.99	275.01
8	65.87	142.41	160.25	245.6	279.2
10	66.5	145.61	159.68	252.33	281.61
12	66.79	147.35	159.13	255.96	282.67
14	66.99	148.62	158.68	258.5	283.43
16	67.1	149.48	158.29	260.23	283.84

It is also observed from the above table that the increasing in layer numbers for the same thickness of the plate with the same case of boundary condition which is simply supported, increase the Natural Frequency clearly, but this increase in Natural Frequency will be also ignored after rising layer numbers above 10 for the same thickness, so it can deduced from that the maximum natural frequency for this plate by using 10 layer for symmetry simply supported composite laminated plate. The effects of number of layer in the laminate are clearly shown Fig.2

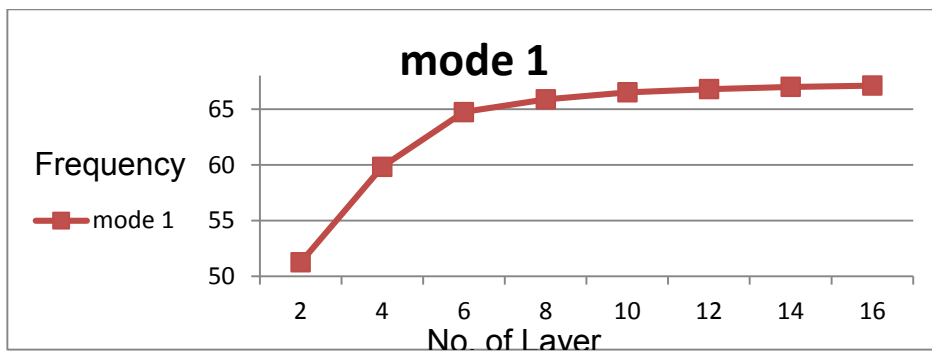

FIGURE 2. Natural frequency (first five mode shape) of simply supported composite laminated plate with various No. of layers

**4.2 Case 2:** Natural frequency of a fixed symmetry cross-ply and angle-ply square laminated composite plate for 10 layers were studied. The composite laminated plate consisted of graphite/epoxy material for 2 boundary conditions, simply supported and fixed has been considered for the current case. In this case the natural frequency has been studied for various layers orientation for the composite laminated plate.

TABLE 3.  
Natural frequency of a 10 layer fixed symmetry angle-ply square laminated composite plate

Angle of layers	mode1	mode2	mode3	mode4	mode5
[-15/15/-15/15/-15]s	110.53	140.55	193.63	269.21	285.42
[-30/30/-30/30/-30]s	107.97	170.99	254.72	262.69	329.57

[-45/45/-45/45/-45]s	106.81	204.85	260	326.39	362.22
[-60/60/-60/60/-60]s	107.97	170.99	254.72	262.69	329.57
[-75/75/-75/75/-75]s	110.53	140.55	193.63	269.21	285.42
[-90/90/-90/90/-90]s	112.02	205.64	251.29	308.78	368.13

From the above tables it is observed that the natural frequency for a 10 layer cross-ply and angle ply composite laminated plate with clamped boundary condition in symmetric arrangement of layers decrease when the angle of ply changes from 0° to 45°, then it increases up to 90°. So the minimum value of natural frequency will be at angle 45° of ply orientation. And it is also observed that the natural frequency in case of angles 15 & 75 are same, and 30 & 60 are same also. The effects of number of layer in the laminate are clearly shown Fig3

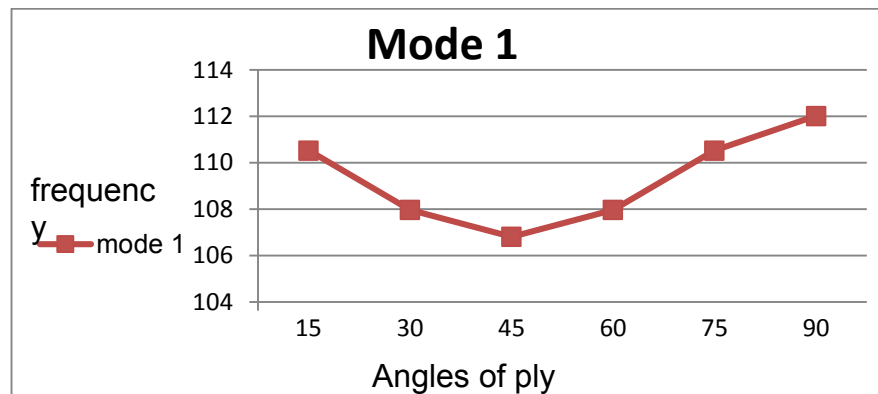

FIGURE 3. Natural frequency (first mode shape) of fixed composite laminated plate with various layer orientations

TABLE 4.

Natural frequency of a 10 layer simply supported symmetry angle-ply square laminated composite plate

Angle of layers	mode1	mode2	mode3	mode4	mode5
[-15/15/-15/15/-15]s	55.62	86.79	138.1	189.46	209.45
[-30/30/-30/30/-30]s	63.134	120.48	176.53	202.08	250.52
[-45/45/-45/45/-45]s	66.5	145.61	169.68	252.33	281.61
[-60/60/-60/60/-60]s	63.134	120.48	176.53	202.08	250.52
[-75/75/-75/75/-75]s	55.62	86.79	138.1	189.46	209.45
[-90/90/-90/90/-90]s	51.344	127.82	161.25	204.13	270.09

From the above tables it is observed that the natural frequency for a 10 layer cross-ply and angle ply composite laminated plate with simply supported boundary condition in symmetric arrangement of layers increase when the angle of ply changes from 0° to 45°, then it decreases up to 90°. So the maximum value of natural frequency will be at angle 45° of ply orientation. And it is also observed that the natural frequency in case of angles 15 & 75 are same, and 30 & 60 are same also. The effects of number of layer in the laminate are clearly shown Fig. 4



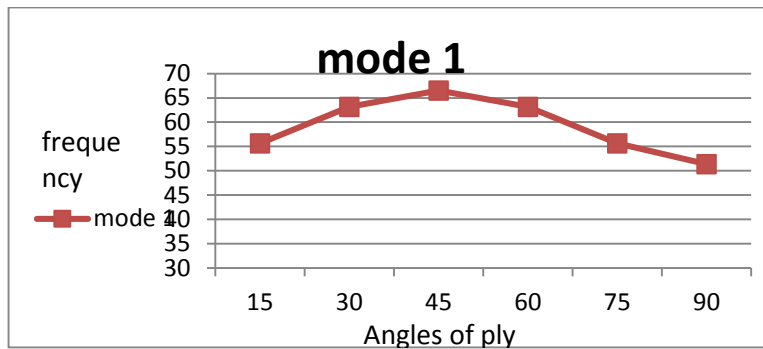

FIGURE 4. Natural frequency (first mode shape) of simply supported composite laminated plate with various layer orientations

## 5. CONCLUSION

The free vibration of a composite laminated plate has been stated. From different boundary condition (simply supported and fixed), it is found that the natural frequency for composite laminated plate in fixed boundary condition is more than in simply supported boundary condition. By increasing the number of layers of the laminated plate for the same thickness it is observed that the maximum natural frequency can be obtained using 10 layers laminated plate for both simply supported and fixed boundary conditions. And it is observed that the maximum natural frequency for angle-ply simply supported composite plate can be found using angle  $[-45 / 45]$  for fiber orientation, and using cross-ply  $[0/90]$  fixed composite plate.

## REFERENCES

- [1] J. K. Ahmed, V. C. Agarwal, P. Pal and V. Srivastav, "Static and Dynamic Analysis of Composite Laminated Plate", *International Journal of Innovative Technology and Exploring Engineering*, vol.3, pp. 56-60, 2013.
- [2] E. F. Crawley, "The Natural Modes of Graphite/Epoxy Cantilever Plates and Shells" *Journal of Composite Materials*, 13; 195 (1979).
- [3] R. L. Ramkumar, N. M. Bhatia, J. D. Labor and J. S. Wilkes, "*Handbook: An Engineering Compendium on the Manufacture and Repair of Fiber-Reinforced Composites*", Prepared for Department of Transportation FAA Technical Center, Atlantic City International Airport, New Jersey, USA.
- [4] W.S. Jian, N. Akihiro, K. Hiroshi, "Vibration analysis of fully clamped arbitrary laminated plate", *Composite Structures* 63, 115–122 (2004).
- [5] I. W. Lee, D.O. Kim, G.H. Jung, "Natural frequency and mode shape sensitivities of damped systems: part I, distinct natural frequencies", *Journal of sound and vibration*, vol-223(1999).
- [6] J. S. Kumar, T. D. Raju and K. V. Kumar, "Reddy- Vibration analysis of composite laminated plates using higher-order shear deformation theory with zig-zag function" *Indian Journal of Science and Technology* Vol. 4 No. 8(Aug 2011).
- [7] H. P. Lee and S. P. Lim, "Vibration of Cracked Rectangular Plates Including Transverse Shear Deformation and Rotary Inertia" *Computer and Structures*, Vol. 49, No, 4, pp. 715-718. (1993).
- [8] Y.M. Desai, G.S. Ramtekkar and A.H. Shah, "Dynamic analysis of laminated composite plates using a layer-wise mixed finite element model" *Compos Structure*, 59:pp. 237-249,(2003).

## **Sustainability In Construction Projects: Part 1 Elements**

Prof. Dr. Bayan S. Al-Nu'man<sup>1</sup>, Asst. Prof. Dr. Thamir M. Ahmed<sup>2</sup>

<sup>1&2</sup> *Department of Civil Engineering, Ishik University, Erbil, KRG-Iraq*

<sup>1</sup>*bayan.salim@ishik.edu.iq, <sup>2</sup>thamir.ahmed@ishik.edu.iq*

### **ABSTRACT**

An attempt is made in this work to put a guideline for the construction officials in the country to measure the sustainability condition of any building construction project. 95 questions to be filled by the supervisors of construction project is being issued and categorized.

**Keywords:** sustainability, sustainable construction, concrete sustainability.

### **1. INTRODUCTION**

While progress is being made in achieving sustainability, even greater levels of energy and environmental efficiency, durability, and renewability are possible as green building practices continue to move forward. The benefits of economic savings and increased occupant productivity provide additional incentives to continue research and development in this field. As more public and private entities invest in sustainable practices, even greater opportunities for savings and optimal use of limited resources will emerge.

### **2. ENVIRONMENTAL CONSTRUCTION GUIDELINES**

#### **2.1 GENERAL CONSIDERATIONS**

The construction process can have a significant impact on environmental resources. It can also minimize the prospect of adverse indoor air quality in the finished building. In addition to yielding environmental benefits, all of these actions can lower project costs. In many cases, construction clears and disturbs the site's existing natural resources native vegetation and wildlife, natural drainage systems, and other natural features and replaces them with artificial systems such as non-native vegetation and artificial drainage. Fig.(1) shows the elements of questionnaire implemented in this work.

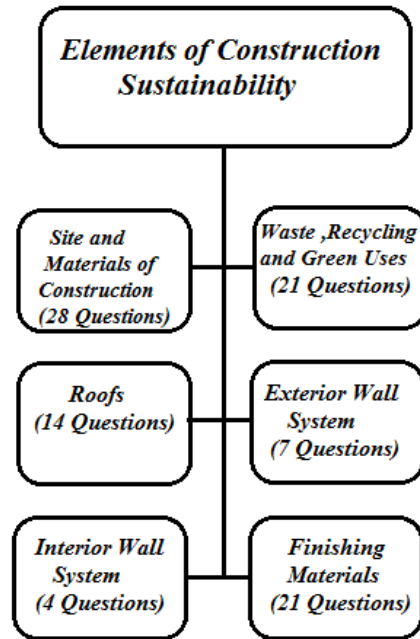

FIGURE1. Questionnaire Flow Chart

## 2.2 DATA TO BE COLLECTED

In this work, an extensive field data of some major construction projects in Kurdistan region is to be collected and studied, in a companion paper, in the path of sustainable construction practice. This is to explore and identify the sustainability of construction projects as a trial to put some points to pave the way for future improvement in this respect.

## 2.3 QUESTIONS WERE APPLIED FOR STUDY

A lot of questions were presented to the projects officials, where the answers required are only by (Yes/No). The (Yes) means that sustainability measures are considered in a satisfactory way, the (No) means that sustainability measures are not considered. The questions required can be classified as follows:

### 2.3.1 SITE AND MATERIALS OF CONSTRUCTION

1. Avoiding construction on prime agricultural land
2. Avoiding construction on undeveloped land that is environmentally sensitive.
3. Avoiding construction on public parkland or land adjacent to bodies of water.
4. Selecting a building that is well connected to existing networks of public transportation

5. Minimizing the building footprint and protecting and enhancing with natural vegetation.
6. Appropriate landscape design and the use of captured rainwater, recycled wastewater.
7. Minimizing impervious ground surface (such as for vehicle parking) and providing a surface drainage system that conducts water to areas on the site.
8. Grading the site to appropriate slopes and planting vegetation that holds the soil in place to prevent erosion.
9. Distinctive site features such as rock formations, forests, grasslands, streams, marshes, and recreational paths and facilities, if destroyed for new construction, can never be replaced.
10. Providing shade, vegetated or reflective roof surfaces, reflective paving materials. Siting a building for best exposure to sun and wind maximizes solar heat gain in winter and minimizes it in summer to save heating and air conditioning fuel.
11. Protect trees and sensitive areas of the site from damage during construction.
12. Topsoil should be stockpiled carefully during construction and reused on the site.
13. Guard against soil erosion by water and wind during construction.
14. Construction machinery should be selected and maintained so that it pollutes the air as little as possible.
15. Surplus excavated soils should be reused either on the site or on another site nearby.
16. Construction wastes are recycled.
17. Clay and shale, the raw materials for bricks, are plentiful.
18. Clay brick can include recycled brick dust, postindustrial wastes such as fly ash.
19. These wastes generally go into landfills or are buried on the site.
20. Sealers applied to brick masonry
21. When a brick building is demolished, sound bricks may be cleaned of mortar and reused.
22. Brick waste can be crushed and used for landscaping. Brick and mortar waste can also be used as on-site fill.
23. Some emissive spray-on fireproofing materials are used?
24. Steel exposed to weather needs to be repainted periodically
25. Steel is galvanized, or given a long-lasting polymer coating, or made of more expensive stainless steel.
26. Steel framing members in building walls and roofs should be thermally broken or insulated in such a way that they do not conduct heat between indoors and outdoors.
27. When a steel building frame is demolished, its material is recycled.
28. Surface oils and protective coatings sometimes outgas and cause occupant discomfort.

### **2.3.2 WASTE, RECYCLING AND GREEN USES**

1. Use waste materials from other industries, such as fly ash from power plants, slag from iron furnaces, copper slag, foundry sand, mill scale, sandblasting grit, and others, as components of cement and concrete.
2. Use concrete made from locally extracted materials and local processing plants to reduce the transportation of construction materials over long distances.
3. Minimize the use of materials for formwork and reinforcing.
4. Reduce energy consumption, waste, and pollutant emissions from every step of the process of concrete construction, from quarrying of raw materials through the eventual demolition of a concrete building.
5. Waste materials such as crushed, recycled glass, used foundry sand, and recycled concrete can substitute for a portion of the conventional aggregates in concrete.
6. Concretes that use less water by using super plasticizers, air entrainment, and fly ash
7. The extra concrete is often dumped on the site, where it hardens and is later removed and taken to a landfill for disposal.
8. An empty transit-mix truck must be washed out after transporting each batch, these wastes can be recovered and recycled as aggregates and mixing water
9. Formwork components can be reused many times.
10. Form release compounds and curing compounds are used.
11. Insulating concrete forms are used.
12. When a concrete building is demolished, its reinforcing steel is recycled.
13. Fragments of demolished concrete can be crushed, sorted, and used as aggregates for new concrete.
14. Demolished concrete is buried on the site, used to fill other sites, or dumped in a landfill.
15. Pervious concrete, made with coarse aggregate only, is used
16. In brown field development, concrete fill materials can be used to stabilize soils.
17. Structured parking garages replace surface parking.
18. Concrete's thermal mass can be exploited to reduce building heating and cooling costs.
19. Lighter-colored concrete paving is used rather than darker asphalt paving.
20. Interior concrete slabs made with white concrete are used.
21. Photo-catalytic agents are added to concrete used in construction of roads and building

### **2.3.3 ROOFS**

1. A roof can conduct rainwater to a cistern, tank, or pond for use as domestic water, industrial water, or irrigation.
2. A properly proportioned overhang is used to shade windows from the high summer sun but admit warming light from the low winter sun.
3. A light-colored roof covering is used.
4. Reflective roofs are used.
5. In a hot climate, a shading layer above a roof, with a freely ventilated space between, is used.
6. A roof surface can support solar heat collectors to provide electrical power
7. Cellulose thermal insulating material is used in roofs.
8. Glass wool and mineral wool thermal insulating material is used in roofs.
9. Polystyrene foam thermal insulating material is used in roofs.
10. Bituminous roofing largely based on asphaltic compounds derived from coal and petroleum is used
11. Roofing felts are made with cellulose or glass fibers.
12. Adhesive bonding, solvent welding, and heat welding of seams may give off volatile organic compounds (VOCs), are used.
13. Materials from demolition of built-up roof membranes are generally incinerated or taken to landfills.
14. Thermoplastic single-ply membranes are used.

### **2.3.4 EXTERIOR WALL SYSTEM**

1. An all-glass exterior wall system is used.
2. Glass is used where it can supply day-lighting and provide views
3. Windows are opened and closed by the occupants.
4. Thermal bridges are eliminated from the exterior wall.
5. Fresh air should be provided by the building's ventilation system, not by air leakage through the exterior wall.
6. Glass is used to provide solar heat to the building in winter, but care must be taken to avoid glare, local overheating, and ultraviolet deterioration of interior surfaces and furnishings that are exposed to sunlight.
7. South-facing surfaces of the exterior wall are used to generate electrical energy.

### **2.3.5 INTERIOR WALL SYSTEM**

1. Gypsum board waste generated during construction is minimized by sizing walls and ceilings to make efficient use of whole boards or by ordering custom-sized boards for nonstandard-size surfaces.

2. Gypsum board scrap can be permanently stored in the hollow cavities of finished walls, eliminating disposal and transportation costs and reducing the amount of material destined for landfills.
3. Additives used in the manufacture of moisture-resistant and fire-resistant gypsum board are potential sources of volatile organic compound (VOC) emissions?
4. Paints, wall-covering adhesives used to finish gypsum surfaces can be significant emitters of VOCs.

### **2.3.6 FINISHING MATERIALS**

1. Finish materials have a high recycled content.
2. Finish materials wastes end up in landfills.
3. Interior finishes derived from rapidly renewable sources, such as bamboo flooring, or from certified woods reduce the depletion of raw materials of limited supply and protect forest ecosystems.
4. Finish materials are extracted, processed, and manufactured locally.
5. Indoor finish materials and coatings including emitters are used? e.g. glues and binders used in wood panels and other manufactured wood products, leveling compounds applied to subflooring, carpet fabrics and backings, carpet cushions, carpet adhesives, antimicrobial and mothproofing carpet treatments, wall covering adhesives, resilient flooring adhesives, vinyl in all its forms, gypsum board joint compounds, curtain and upholstery fabrics, paints, varnishes, stains, and more.
6. Formaldehyde gas is used? It is an irritant to building occupants, causes nausea and headaches, and can exacerbate asthma.
7. Volatile organic compounds are used? They re air pollutants.
8. The chemical 4-phenylcyclohexene is used? It is emitted by rubber binders used in some carpets and pads. It is carcinogenic.
9. Floor plans are used that are flexible and easily adapted to new uses and partition systems that are easy to modify encourage building reuse.
10. Use of high ceilings, low partitions, transparency, reflective surfaces, and light colors can maximize day lighting potential and views to the exterior.
11. Spaces designed with exposed structure and without suspended ceilings save materials.
12. Acoustical ceiling tiles are used? They can be a source of volatile organic compound (VOC) emissions as well as a reservoir for emissions from other sources.
13. Low-emitting acoustic tiles are used.

14. Concrete, stone, masonry, ceramic tile, and cementations mortars and grouts are used. They are chemically inert and generally free of emissions.
15. Organic adhesives used in tiling and resins are used? They may be sources of emissions?
16. Sealers applied to hard flooring materials to provide water repellency and protections from staining are potential sources of emissions. Used or not?
17. Self-leveling cements used to prepare subfloors for resilient flooring coverings are potential sources of emissions. Used or not?
18. Vinyl (polyvinyl chloride) is a component of many resilient floor coverings and other interior finish products.
19. Carpets and cushions are made with at least some recycled material.
20. Factory-applied adhesives are used? They tend to have lower VOC emissions than adhesives applied on the construction site.
21. Carpet tiles or full carpets are used? tiles allows easy spot replacement, lessens the need for full carpet replacement when a small area becomes worn or damaged, thus extending the life of the carpet installation and reducing waste.

### **3. CONCLUSIONS**

Wide scale questionnaire is developed and arranged in this work. The questionnaires are categorized in six main parts of construction projects of buildings. The total number of 95 questions covers almost the majority of construction steps that having a considerable impact on the environment in many ways.

The questionnaire developed hereby is applied on several big construction projects in Kurdistan Region of Iraq.

The authors present this paper as a proposal of sustainability measurements guide for the construction officials in the region.



## REFERENCES

- [1] Schokkwe ,A.J , “The Sustainable Concrete Guide Applications” US Green Concrete Council , Farmington Hills , MI 4833USA , 2010 , 183pp
- [2] Allen E. and Iano J. “Fundamentals of BC Materials and Methods ,” Wiley ,5<sup>th</sup> Ed ,2009 , 1010pp
- [3] Pulaski , M.H , Editor , “Field Guide of Sustainable Construction” The Pennsylvania State University , PA USA. 2004 ,312pp
- [4] Smartz, B.W , Laker , T.S. and VanDam ,T “ Performance and Sustainability” Concrete International , American Concrete Institute , Sept.2013 ,pp 39-43
- [5] Koji Sakai, Takafumi Noguchi, “The Sustainable Use of Concrete” , August 30, 2012 by CRC Press,188pp
- [6] Gajanan M. Sabnis , “Green Building with Concrete: Sustainable Design and Construction”, CRC Press, 2011 ,336pp

## **Sustainability In Construction Projects: Part 2 (Case Studies)**

Prof. Dr. Bayan S. Al-Nu'man<sup>1</sup>, Asst. Prof. Dr. Thamir M. Ahmed<sup>2</sup>

<sup>1&2</sup> *Department of Civil Engineering, Ishik University, Erbil, KRG-Iraq*

<sup>1</sup>*bayan.salim@ishik.edu.iq, <sup>2</sup>thamir.ahmed@ishik.edu.iq*

### **ABSTRACT**

The guideline developed in a companion study by the authors is applied and studied in this work to assess the sustainability score of several big construction projects in Kurdistan Region of Iraq. Results were varied as the sustainability measures being applied on certain steps and neglected on many others. Attention on this issue can be found in the conclusions.

**Keyword:** sustainability, sustainable construction, concrete sustainability.

### **1. INTRODUCTION**

Sustainable building practices are being adopted by an increasing number of building owners, both public and private, for both new construction and renovations. Green building initiatives, including the adoption of public policy and practices, are expanding each year in cities and counties across the world. In our country, building owners and operators from major corporations to small businesses, along with product manufacturers, construction companies, and financiers, should discover the economic and environmental benefits of green buildings.

### **2. ENVIRONMENTAL CONSTRUCTION GUIDELINES**

#### **2.1 GENERAL CONSIDERATIONS**

The construction professional's responsibility is to fulfill the project objectives in accordance with the construction contract, construction drawings and specifications, project schedule, and project budget. The contractor's goal is to build the project for the lowest costs within the tightest time-frame, and at the highest profit. The contractor is not likely to implement environmental practices unless they involve almost no additional cost, have been required contractually, or are economically beneficial to the contractor.

#### **2.2 DATA COLLECTED**

In this work, an extensive field data of some major construction projects in Kurdistan region is collected and studied in the path of sustainable construction practice. This is to explore and identify the sustainability of construction projects as a trial to put some points to pave the way for future improvement in this respect.

### 2.3 QUESTIONNAIRES APPLIED FOR STUDY

A lot of questions were presented to the projects officials, where the answers required are only by (Yes/No). The (Yes) means that sustainability measures are considered in a satisfactory way, the (No) means that sustainability measures are not considered. The questions required can be classified as mentioned in companion study:

TABLE 1.  
List of projects

Projects	Title	Owner	Contractor	Cost	Area	Description
Empire world	Empire World-West wing project	Falcon Group	B.C Company	112000000\$	40 000 M <sup>2</sup> , 165 000 M <sup>2</sup> Gross build-up area	11 High-rise buildings, totaling 944 apartments
Addala tower	EBTC	NRN	Ogulu Company	N/A	5000m <sup>2</sup>	Tunnel form structure with 36 floors and 3 basements
Stadium	Stadium	Ministry of youth	Al-Mansour Contracting	2 550 000\$	42 000m <sup>2</sup>	Football field with main buildings , Cafeterias and green spaces
Residential project	Residential Compound	Ministry of construction and housing	Al-mansoor Contracting	150000000\$	84430m <sup>2</sup>	100 houses with an area of 300m <sup>2</sup> /house
4Towers	4Towers	Ashoor ban	Aksa Yapi	60 000 000\$	10 000m <sup>2</sup>	residential apartments (287 unit )
Ashti City '1'	Ashti city "1"	N/A	Eskan company for investment and real-estate development	76 000 000\$	1000000m <sup>2</sup>	1520 units of residential houses
Ashti City '2'	Ashti City "2"		Eskan Company for investment and real-estate development	130 000 000 \$	1 000 000m <sup>2</sup>	1100 units of different house plans
Global city	Global city		Eskan company	200 000 000\$	1 200 000m <sup>2</sup>	1200 units of villas

EMC	EMC			10 000 000 \$	850 000m <sup>2</sup>	
Hospital	Hawler General Hospital	Ministry of health	Darin Group	50 000 000\$	70 000m <sup>2</sup>	
Hotel	Hotel	Al-saqr contracting		8 000 000\$	450m <sup>2</sup>	8 floors hotel with basement
School	Secondary school	Ministry of education	private contractor	2 200 000\$	8000m <sup>2</sup>	18 classes with labs computer rooms and administration.
Motel	ministry of municipalities	private	220 000\$	165m <sup>2</sup>	Brief description: basement with 3 floors	
Hospital Park View	Royal hospital	N/A		10 000m <sup>2</sup>		

### 3. ANALYSIS AND DISCUSSION OF WORK

#### 3.1 SITE MATERIALS

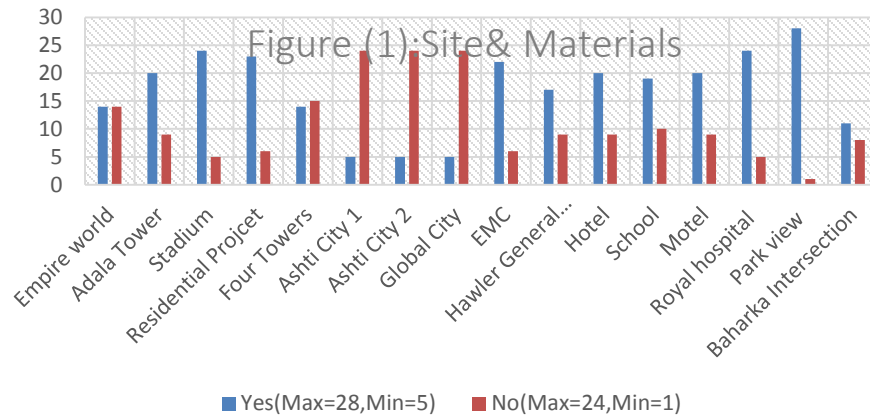

FIGURE 1. Site & Materials

### 3.2 WASTE PREVENTION

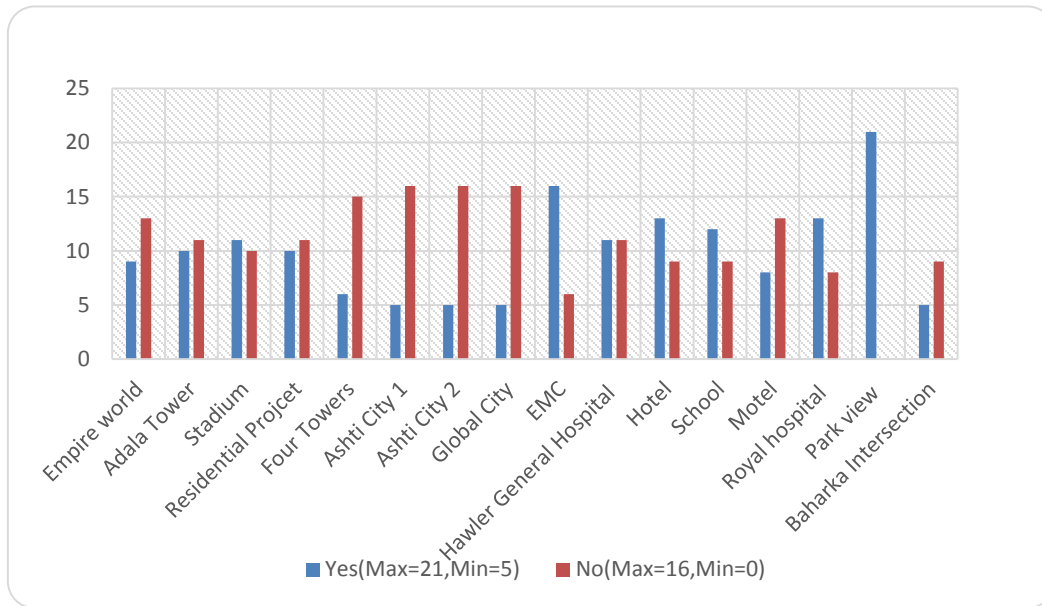

FIGURE 2. Waste Prevention

### 3.3 ROOF

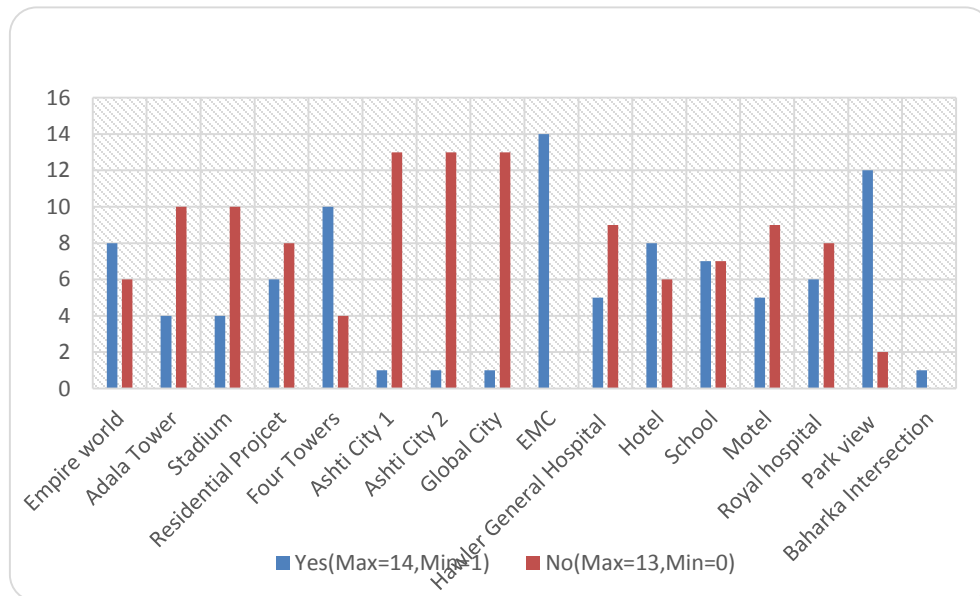

FIGURE 3. Roofs

### 3.4 EXTERIOR WALLS

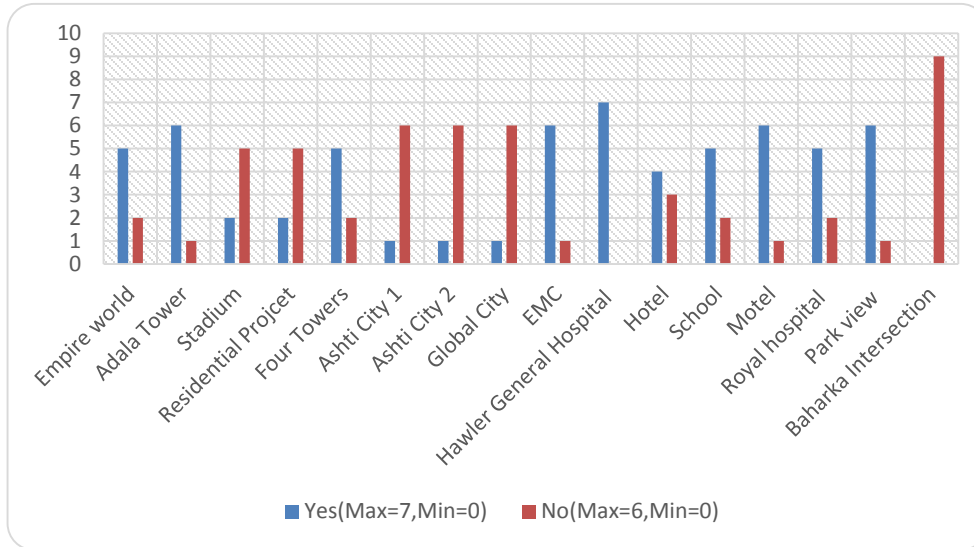

FIGURE 4. External Walls

### 3.5 INTERIOR PORTION WALL

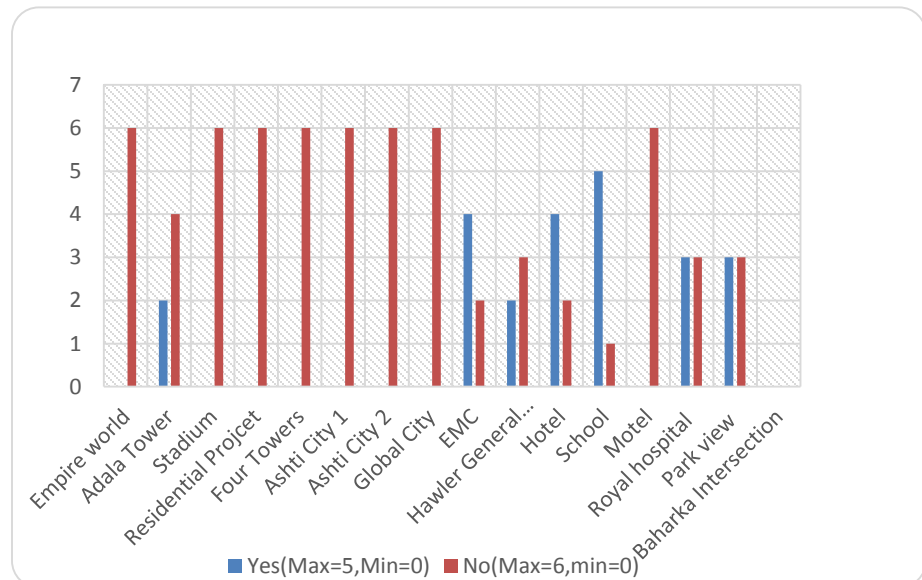

FIGURE 5. Internal Walls

### 3.6 FINISHING MATERIALS

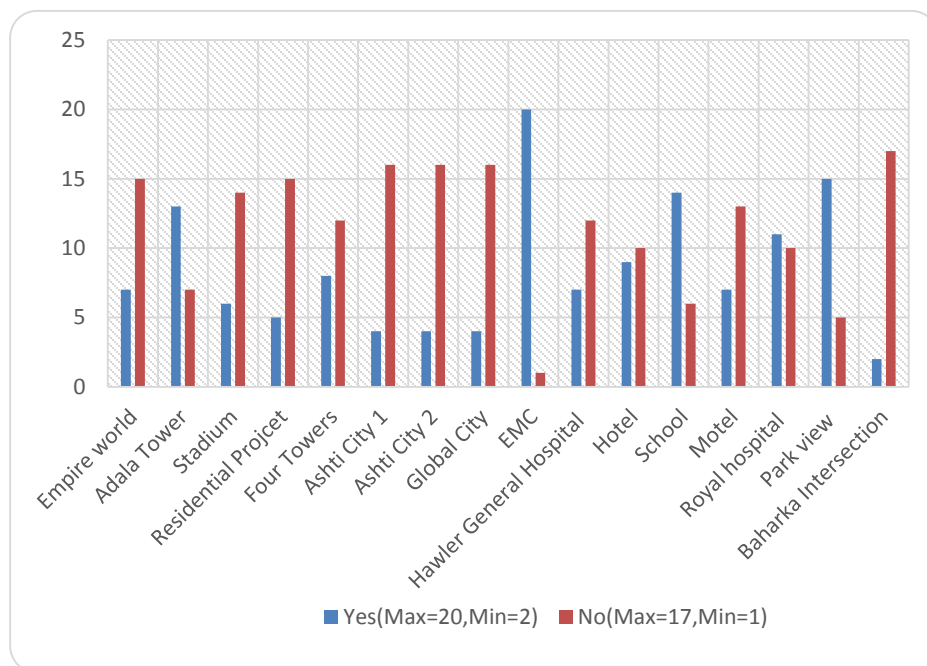

FIGURE 6. Finishing Materials

TABLE 2.

Summary of Questionnaire output

Elements of sustainability	Average(yes/no)	Max-Yes	Min-Yes	Max-No	Min-No
Site & materials	16.9/11.1	28	5	24	1
waste	10/10.8	21	5	16	0
Roofs	5.8/7.3	14	1	13	0
Ext.walls	3.8/3.25	7	0	6	0
Int.wall partition	1.4/4.1	5	0	6	0
Finish Materials	8.5/11.5	20	2	17	1

From table (2) it can be seen that answers (Yes) sustainability measures are considered and (No) means sustainability measures are not considered are approximately equally divided, it reflects that sustainability measures in overall are considered approximately 50% .

The next discussion puts more light on the study

TABLE 3.  
Sustainability Scores of the projects

	Empire	adala	stadium	Res.project	4towers	Ashti city 1	Ashty city 2	Global city
Site & materials	50%	70%	83%	80%	48%	17%	17%	17%
Waste prevention	41%	48%	52%	48%	29%	24%	24%	24%
Roofs	57%	28%	29%	43%	71%	7%	7%	7%
Ext.walls	71%	86%	29%	29%	71%	14%	14%	14%
Int.wall partitions	0%	33%	0%	0%	0%	0%	0%	0%
Finish materials	32%	65%	30%	25%	40%	20%	20%	20%
Average %	49%	55%	37%	37%	43%	17%	17%	17%
Deviation $\sigma$	24.5%	22.6%	28%	26.7%	27%	8.8%	8.8%	8.8%

TABLE 4.  
Sustainability Scores of the projects (continued)

	Emc	H.G.H	Hotel	Motel	Royal.H	School	Park view	Bahrka inter.
Site & materials	79%	65%	69%	69%	83%	66%	97%	58%
Waste prevention	73%	50%	59%	38%	62%	57%	100%	36%
Roofs	100%	36%	57%	36%	43%	50%	86%	100%
Ext.walls	86%	100%	57%	86%	72%	71%	86%	0%
Int.wall partitions	66%	40%	66%	0%	50%	83%	50%	0%
Finish materials	95%	37%	43%	35%	52%	70%	75%	11%
Average %	83%	55%	59%	44%	60%	66%	82%	34%
Deviation $\sigma$	13%	24.7%	9%	30%	15%	11.5%	18%	39%

In General, as the % value increase, the sustainability measurements are better.

The following charts shows the highest and lowest Average% for several



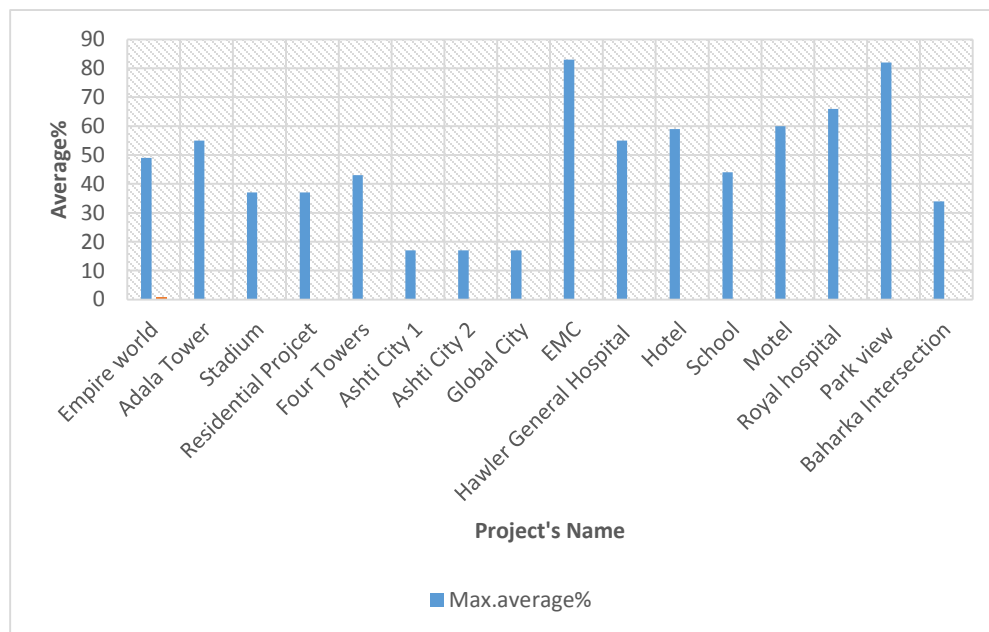

FIGURE 7. Max. Average of Scours

#### 4. CONCLUSIONS

1. The highest sustainability score in “Site” was (97%) for project (park view). The lowest sustainability score for “Site” was (17%) for projects (Ashti city 1, Ashti city 2 and Global city).
2. The highest sustainability score in “Waste” was (100%) for project (park view). The lowest sustainability score for “Waste” was (24%) for projects (Ashti city 1, Ashti city 2 and Global city).
3. The highest sustainability score in “Roofs” was (100%) for project (Emc and Bahrka intersection). The lowest sustainability score for “Roofs” was (7%) for projects (Ashti city 1, Ashti city 2 and Global city).
4. The highest sustainability score in “Ext.walls” was (100%) for project (Hawler general hospital). The lowest sustainability score for “Ext.walls” was (0%) for projects (Bahrka intersection).
5. The highest sustainability score in “Int.walls” was (83%) for project (School structure). The lowest sustainability score for “Int.walls” was (0%) for projects (Residential compound, 4towers, Ashti 1, Ashti 2, Global city, Motel and Bahrk intersection).
6. The highest sustainability score in “Finish Materials” was (95%) for project (Emc). The lowest sustainability score for “Finish Materials” was (11%) for projects (Bahrka intersection).
7. The highest Overall “ave”. sustainability score was (83%) for the project (EMC).

8. The lowest overall “ave”. Sustainability score was (8.8%) for the projects (Ahsti city 1, Ashti city 2, Global city).
9. The reason for the Project (EMC) to be the best score are attributed to the careful deal with (Roofs, Ext.walls and Finish materials)
10. The reason for the Projects (Ahsti city 1, Ashti city 2, Global city) to be the lowest score are attributed to the poor deal with (Int.walls and Roofs)

## **REFERENCES**

- [1] Schokkwe ,A.J , “The Sustainable Concrete Guide Applications” US Green Concrete Council , Farmington Hills , MI 4833USA , 2010 , 183pp
- [2] Allen E. and Iano J. “Fundamentals of BC Materials and Methods ,” Wiley ,5th Ed ,2009 , 1010pp
- [3] Pulaski , M.H , Editor , “Field Guide of Sustainable Construction” The Pennsylvania Statc University , PA USA. 2004 ,312pp
- [4] Smartz, B.W , Laker , T.S. and VanDam ,T “ Performance and Sustainability” Concrete International , American Concrete Institute , Sept.2013 ,pp 39-43
- [5] Koji Sakai, Takafumi Noguchi, “The Sustainable Use of Concrete” , August 30, 2012 by CRC Press,188pp
- [6] Gajanan M. Sabnis , “Green Building with Concrete: Sustainable Design and Construction” , CRC Press, 2011 ,336pp

## Prediction Of Pressure Coefficients For Flat Lip Vertical Gates

Assoc. Pro.Dr.Thamir M. Ahmed

*Department of Civil Engineering, Ishik University, Erbil, KRG-Iraq  
Thamir.ahmed@ishik.edu.iq*

### ABSTRACT

The main function of dam structures is to regulate the discharges and heads of water required to satisfy the demand of power generation and water quantity supplied to river or stream behind the structure, hence the sluice gate will play the big role to achieve this process and then its design needs much more attention. The sluice gate within the tunnel of the dam is exposed to many types of static and hydrodynamic forces. Among these forces is the hydraulic downpull force which created from difference between downward force produced by flow passing over the top surface of gate and uplift force exerted by the jet flow on bottom gate surface. The evaluation of positive and / or negative downpull force values is important due to its effects on closure of the gate. The estimation of such force needs determination of many related parameters such as pressure distribution along and cross the bottom gate surface, top pressure, jet velocity issuing below the gate, operation head and the head downstream the gate shaft. In present research, the hydraulic model is used to carry out the required measurements and different types of gate lip shapes have been examined with various flow conditions and gate openings to evaluate the downpull force coefficient. The analysis of results assured that the geometry of the lip gate has significant effects on the hydrodynamics forces and consequently on its operation which in the case of its negative value will prevent the gate to close and make some failures and damages.

**Keyword:** flat gate, pressure, coefficient.

### 1. INTRODUCTION

Vertical lift or sluice gates are one type of gates which are used to control the water flowing through closed conduit or tunnels [1]. These gates move vertically through a suitable clearances of a shaft located within the tunnel and accordingly the water will be permitted to flow over and below the gate. As a result of such pattern of water flow, two kinds of forces will be produced, first one established downward by water passing over the gate top surface whereas the other acts vertically upward as the water issuing beneath the gate. The difference between these two forces termed by downpull force which affects the stability and safety of gate during its operation. The prediction of downpull force based upon the following parameters; upstream and downstream heads, top and bottom pressure distribution and jet velocity in venna- contracta just below the gate. However, the values of these parameters were taken from physical measurements carried out by many runs of hydraulic model with different gate geometries, gate openings and various values of discharges. The importance behind the estimation of

downpull force magnitude is due to its affects on the design of the gate –hoisting equipment, and also to avoid the negative values which may caused the prevention of gate closure.

## 2. LITERATURE REVIEW

The prediction of downpull force coefficients and all relevant parameters have received much more attention by the hydraulics researchers according to their importance in gates design. Cox et al [2] have developed a dimensionless relationship among many hydraulic variables for estimating the stability of the gate .Naudascher et al [3] have conducted experiments on a hydraulic air model to formulate the effects of many parameters on high head leaf gates . The formulation can be expressed as follows:

$$K_d = K_t - K_b \quad (1)$$

Where

$K_d$ : Downpull coefficient,

$K_t$ : Top pressure coefficient, and

$K_b$ : Bottom pressure coefficient.

The values of  $K_t$  and  $K_b$  can be predicted by following expression:

$$K_t = \frac{H_t - H_d}{V_j^2 / 2g} \quad (2)$$

$$K_b = \frac{H_i - H_d}{V_j^2 / 2g} \quad (3)$$

Where

$H_t$ : Peizometric head on the top gate surface, m,

$H_i$ : Average peizometric head on the bottom gate surface, m,

$H_d$ : Peizometric head downstream the gate shaft, m, and

$V_j$ : Jet velocity issuing beneath the gate, m/sec.

Sagar et al [4] have reported that the numerous geometrical features of the gate influencing the downpull force can be formulated as follows:

$$F_d = f \left( H, \frac{Y}{Y_o}, \frac{e}{d}, \theta, \frac{b_1}{b_2}, \frac{d'}{d}, \frac{d}{Y_o}, \frac{r}{d} \right) \quad (4)$$

Where:

$H$ : Operating head, m,

$\frac{Y}{Y_0}$  : Opening ratio,

$(e/d, \theta)$  : gate bottom geometry,

$\frac{b_1}{b_2}$  : Gap width ratio,

$\frac{d'}{d}$ : Thickness ratio of the skin plate to the top assembly,

$\frac{d}{Y_0}$ : Gate thickness ratio, and

$\frac{r}{d}$ : Curvature radius on upstream bottom portion of the gate.

The downpull force ( $F_d$ ) can also be expressed as follows [5]:

$$\frac{F_d}{0.5 \rho A V_j^2} = \frac{F_t}{0.5 \rho A V_j^2} - \frac{F_b}{0.5 \rho A V_j^2} \quad (5)$$

Where

$F_t, F_b$ : Top and bottom forces respectively,

$A$ : Appropriate gate cross sectional area.

The downpull force coefficient can also be expressed in terms of upstream head as shown below [5]:

$$K_d = \frac{F_d}{\rho \cdot g \cdot H \cdot A} \quad (6)$$

Where:

$\rho$  : Mass density of water, and

$H$ : Operating head, m.

### 3. EXPERIMENTAL WORK

The experiments were achieved by run the hydraulic model with all required measurements for evaluating the pressure coefficients which represent the main components of downpull force. The measurements included the upstream and downstream pressure heads, pressure heads above the gate top surface, jet velocity through the gate opening and distribution of pressure heads along the bottom gate surface [6].

Figure. (1) Shows the schematic layout of hydraulic model with all the necessary components required for measurements in the current research.

#### 4. RESULTS AND DISCUSSION

##### 4.1 VARIATION OF PRESSURE COEFFICIENTS

Figures (2 to 5) show the variation of ( $K_t$ ,  $K_b$  and  $K_d$ ) for various gate shapes and openings and the values of these coefficients were obtained from the application of equations 1,2 and 3.

It can be seen from Figure (2) that the top pressure coefficient ( $K_t$ ) has a little bit change with values of ( $Y/Y_o$ ), whereas ( $K_b$ ) has smooth variation with negative values up to ( $Y/Y_o=0.7$ ) and then turned clearly to be positive with rapid increasing, hence, the ( $K_d$ ) has been affected accordingly and its values were dropped from approximately high uniform values up to ( $Y/Y_o=0.5$ ) into effective low values for remaining gate opening ratios. Such distribution of ( $K_d$ ) reflects the behavior of stream lines on bottom gate surface where the flow is separated from the leading edge of gate bottom surface and produced negative values of ( $K_b$ ) and then caused increasing in ( $K_d$ ) values. For ( $Y/Y_o > 0.5$ ), the reattachment of flow stream lines occurred and led to increase in the values of ( $K_b$ ) and consequently caused decreasing in values of ( $K_d$ ).

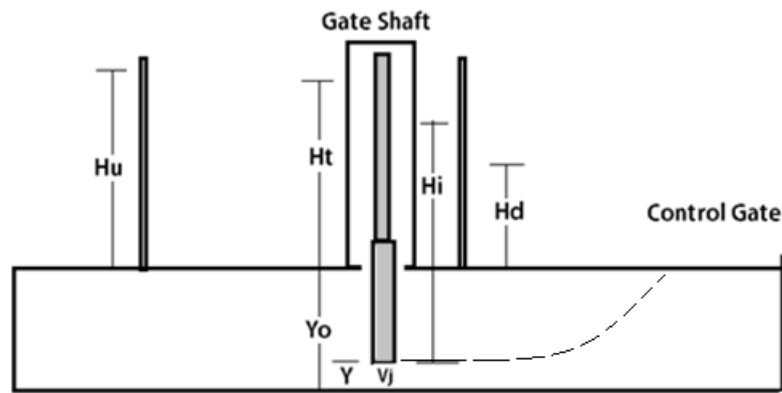

FIGURE1. Schematic Layout of Hydraulic Model

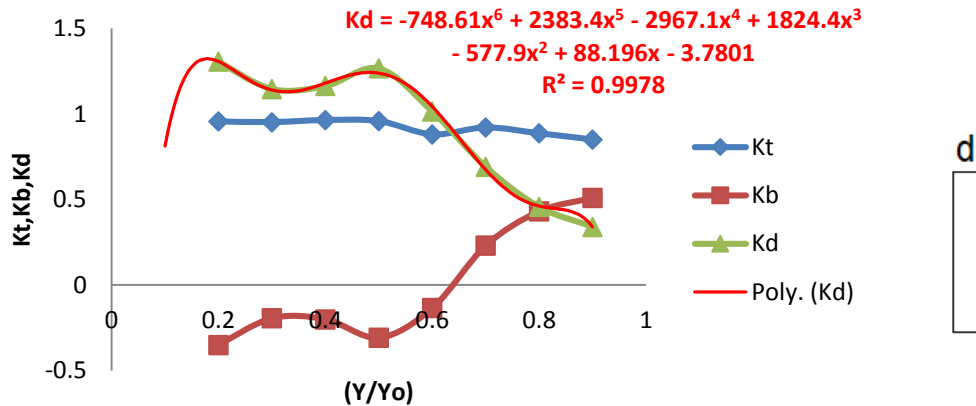

FIGURE 2. Pressure coefficients for gate lip shape no. (1)

#### 4.2 EFFECTS OF LIP SHAPES ON PRESSURE COEFFICIENTS

Figures (3) and (4) show the variations of ( $K_t$ ,  $K_b$  and  $K_d$ ) with ( $Y/Y_o$ ) for flat gate lip shapes provided by different ratios ( $e/d=0.34$  and  $e/d=0.5$ ) of upstream lip extension .Figure (3) shows that the values of ( $K_t$ ) were smoothly decreased with ( $Y/Y_o$ ), while the separation of flow from bottom gate surface led to produce negative values of ( $K_b$ ) for opening ratios up to ( $Y/Y_o=0.6$ ), which then suddenly changed to be positive and forced ( $K_d$ ) to vary consequently from low to high values.

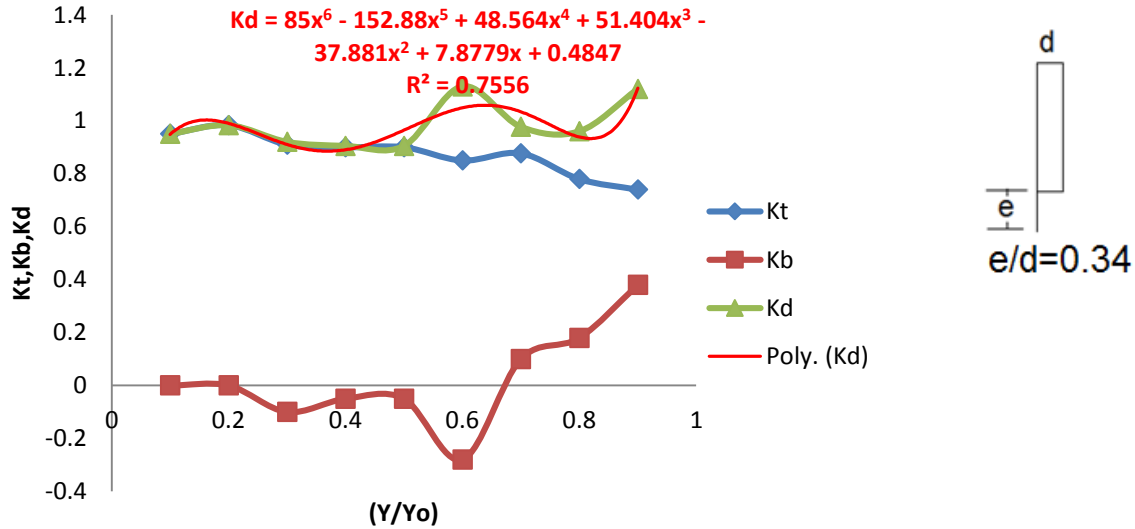

FIGURE 3. Pressure coefficients for gate lip shape no. (2).

#### 4.3 EFFECTS OF LIP SHAPES EXTENSION ON PRESSURE COEFFICIENTS

Figure (4) revealed that the additions of upstream lip gate extension with ( $e/d=0.5$ ) caused the flow to separate from bottom gate surface and maintain ( $K_b$ ) values mostly uniform and low negative for all ( $Y/Y_o$ ) ratios except ( $Y/Y_o=0.9$ ). However, the ( $K_t$ ) values are uniformly decreased and control the values of ( $K_d$ ) to be within small range of variation with openings ratios.

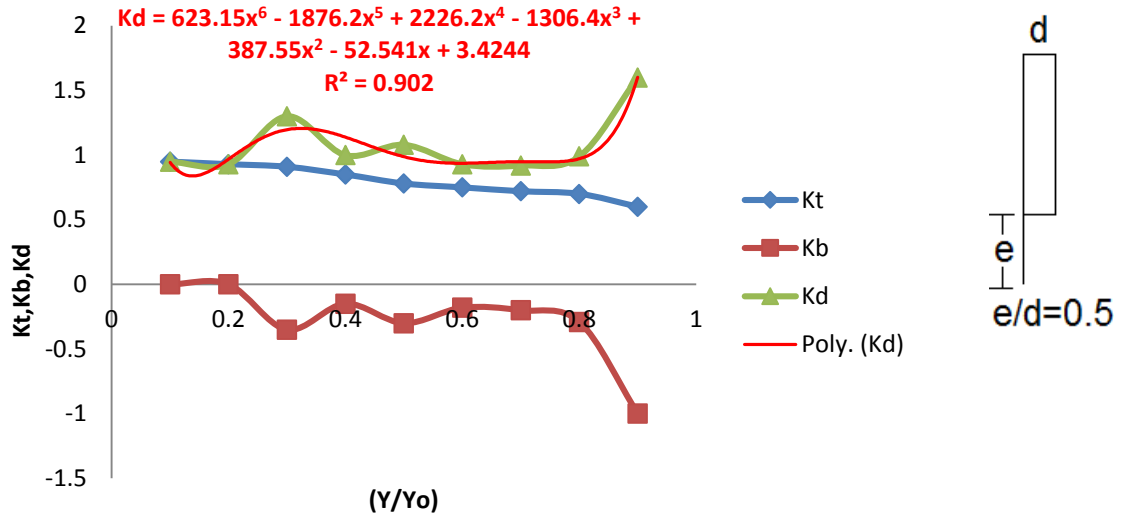

FIGURE 4. Pressure coefficients for gate lip shape no. (3).

The variations of downpull pressure coefficient are demonstrated in figure (5) for all lip gate shapes considered in present study. The comparison of ( $K_d$ ) between the gate shapes indicates that in the case of flat lip gate shape (No.1), the values of ( $K_d$ ) are mostly higher than others up to ( $Y/Y_o=0.5$ ) and then decreased rapidly toward low positive values beyond ( $Y/Y_o=0.6$ ). The values of ( $K_d$ ) for lip gate shapes with lip extensions (No.2 with  $e/d=0.34$ ) and (No.3 with  $e/d=0.5$ ) are ranged in general between (1 and 1.4) and the shape (No.3) produced higher values of ( $K_d$ ) just up to ( $Y/Y_o=0.5$ ).

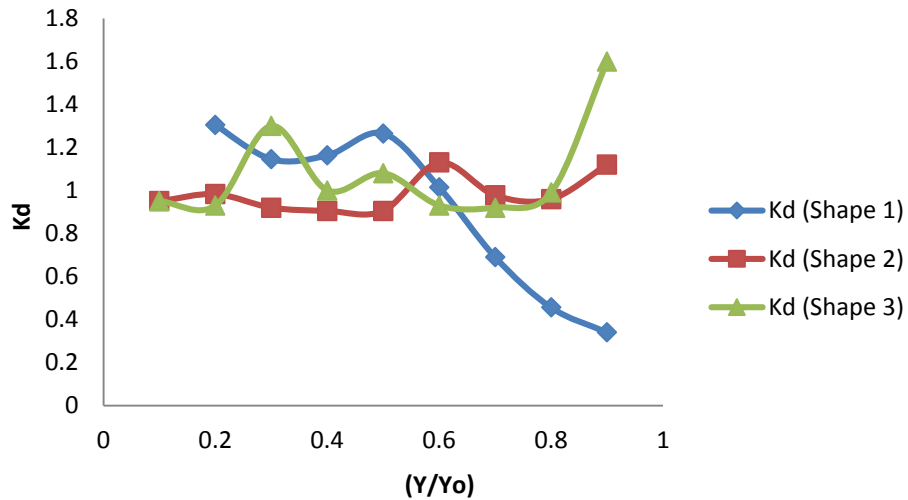

FIGURE 5. Down pull Pressure coefficients for considered gate lip shapes.



## 5. CONCLUSION

All required measurements for the downpull force coefficients estimation are carried out by using hydraulic model experiments, the flat lip gate shapes with and without lip extensions are used. The variations of ( $K_t$ ,  $K_b$  and  $K_d$ ) were studied and the following conclusions are observed:

1. The top pressure coefficients ( $K_t$ ) are seen in general to be invariant with gate opening ratios and have no significant effects on values of ( $K_d$ ).
2. For flat lip gate shape and flat lip gate with lip extension of ( $e/d=0.34$ ), the values and distribution of ( $K_b$ ) indicated that the separation of flow has been occurred with gate openings ratios up to ( $Y/Y_o=0.6$ ), whereas the reattachment of flow was established for remaining ratios of gate opening. Accordingly, the values of downpull force coefficients have been affected mainly by values of ( $K_b$ ).
3. The values of ( $K_b$ ) had no strong changes and still negative for the lip gate shape with lip extension of ( $e/d=0.5$ ). This means no reattachment of flow has been occurred for all values of ( $Y/Y_o$ ).
4. It is found from the analysis of the results that the downpull force coefficient ( $K_d$ ) can well be expressed by polynomial function with good correlation coefficients. An attempt was made to show that the downpull force coefficient ( $K_d$ ) can be represented by polynomial equation. In these equations the values of ( $x$ ) referred to gate opening ratios. These equations are viewed within the plot areas of figures.
5. The downpull force coefficient ( $K_d$ ) is influenced by additions of the lip extension to upstream edge of the gate where its values are fluctuated and dominated in general between (1 and 1.2), while for flat gate without extension, the values of ( $K_d$ ) varied significantly from high to low values.

## REFERENCES

- [1] US Bureau of Reclamation, "Hydraulic Downpull Force on large Gates", Research Report No.4 (1966).
- [2] Cox Robert G. and Ellis B. Pickket and W.p. Simmons "Hydraulic Downpull on High Head Gates", Asce Discussion HY5, May (1960).
- [3] Naudascher, E., Helmut E. Kobus, and Ragam P. Rao, "Hydrodynamics Analysis For High Head Leaf Gates", ASCE Vol.90, No. HY3, 1964.
- [4] Sagar, B.T.A. and J.P. Tullis, "Downpull In Vertical Lift Gates", Water Power & Dam Construction, December (1979).
- [5] Sagar, B.T.A., "Downpull In High -Head Gates Installation", Water Power & Dam Construction, March, April, and May (1977).
- [6] Ahmed, Th.M., Effects of Gate Lip Shapes On The Downpull Force In Tunnel Gates", Thesis Presented To The Baghdad University In Partial Fulfillment Of The Requirements For degree Of Doctor Of Philosophy In Hydraulic Engineering, March (2000).

## Effects of Gate Geometries on Top Pressure Coefficient of Dam Tunnel Gate

Assoc.prof.Dr.Thamir M. Ahmed<sup>1</sup> ,Mrs.Awat Omar Anwar<sup>2</sup>

<sup>1</sup> *Department of Civil Engineering, Ishik University, Erbil, KRG-Iraq*  
<sup>2</sup> *Civil and Infrastructure engineering Dept., Fatih University, Istanbul, Turkey*  
<sup>1</sup> *thamir.ahmed@ishik.edu.iq, <sup>2</sup>awat\_o\_@yahoo.com*

### ABSTRACT

Vertical lift tunnel type gates are subjected to hydrostatic and hydrodynamics forces created as a result of operation conditions over a wide range of partial openings, discharge and heads. Among these forces is the downward hydrodynamic force resulting from the effects of flow issuing over the top gate surface. The evaluation of this force needs the determination of top pressure coefficients which based mainly upon the measurements of the jet flow velocity across the vena-contracta , pressure head variation on the top gate surface and pressure head of flow just downstream the gate shaft. In the present research, a random hydraulic model was created to specify the effect of twelve gate lip shapes on the behavior of flow and consequently on the top pressure coefficients. The results reveal that no significant of gate geometry on the top pressure coefficient.

**Keywords:** Top Pressure Coefficient, Downpull Force, Vertical Lift Gate.

### 1. INTRODUCTION

The design of vertical lift tunnel gates is influenced by several hydraulic factors. The main factor between them is the downpull force which results from the difference between the downward force applied by water passing over gate through the gate shaft and the upward force on the gate bottom plate formed by jet flow below the gate. The downpull force is influenced by different parameters which can be classified as fluid properties such specific weight of water and viscosity, operating head on the gate, flow conditions which involve whether free or submerged flow exists , ventilation downstream the gate, , geometry of gate installation including gate shaft dimensions, gate thickness and gate openings.

Al-Kadi (1997); presented a one dimensional analyses to estimate the downpull forces acting on the lift gate by predicting the mean top and bottom pressure coefficients and the velocity distribution using two finite element models, one with constant eddy viscosity, and the other of variable eddy viscosity which is important in determining the negative downpull for large gate openings. The model was verified using analytical prediction and gave good agreement.

The effects of many gate geometries with different gap width ratios on downpull force are examined by Ahmed (1999) ;the study based upon the results analyses of the measurements obtained from experimental runs conducted by using hydraulic laborator. model .The Study include the investigation of top pressure coefficient for various gate lip shapes and openings main and indicate its effects on downpull forces .

The hydraulic model of tunnel type-high head gate is used by Drobir et.al (2001);to investigate the effects of many tail water flow conditions on downpull. The model measurements were carried out for free and submerged flow behind the gate shaft and the results were compared with those obtained from the method of calculations suggested by the Naudascher (1991).

A numerical analysis for studying the hydrodynamic forces on a vertical lift gate through the viscous flow is developed by Andrade and Amorim.(2003) The numerical solution of incompressible Navier-Stokes equations was adopted based upon the principles of finite element .The effects of turbulent flow is simulated by using (k-ε) turbulence model and the results compared with data obtained from experimental work for different gate openings.

The simulation model based upon a two-dimensional CFD was used by Almaini et al 2010; to estimate the top pressure, bottom pressure and downpull coefficients ,then after, verified the model with results of experimental data measurements conducted by Ahmed (1999); for many shapes of gate lip. Naderi and Hadipour (2013); were studied the distribution of pressure and related hydrodynamic forces on the valve of channel outlet for many opening ratios by using Numerical Solution of “Fluent” software based on finite volume method. The velocity of flow was also studied and the results compared with those obtained from physical model. The comparison showed a good agreement between the numerical model and previous studies and indicated that the increasing of openings caused decrease in pressures and the downpull force produced according to the difference between the top and bottom pressures.Brankovic and Drobir (2013); were found that the using of new smooth upstream face high head gate will reduce hydrodynamic forces in case of absence of negative downpull forces. The study reveal that new smooth upstream high head leaf gate improved safety for the hydro-machinery equipment and minimizing costs, and reduced the hoist forces.

In the current study, the water flow controlled by leaf gate in dams under high pressure had been modeled using hydraulic laboratory model to estimate the top pressure coefficients which affect directly the downpull force on the gate lip. The model was checked many gate lip shapes.

The top pressure coefficient ( $K_t$ ) considered as a function of several factors related to gate geometry and flow conditions which can be express in the following form:

$$K_t = f\left(H_t, \frac{v_j^2}{2g}, H_d\right) \quad (1)$$

Where

$K_t$ : Top pressure coefficient,

$H_t$ : Peizometric head on top gate surface,

$\frac{v_j^2}{2g}$ : Jet velocity head, and

$H_d$ : Downstream peizometric head.

However, in order to discover the disturbed forces applied on the top gate surface, many experiments were carried out, concerned all required measurements and observed the basic factors and conditions. The experiments were achieved by examine 12 different gate lip shapes to cover the main variables affected the magnitudes of top pressure coefficient.

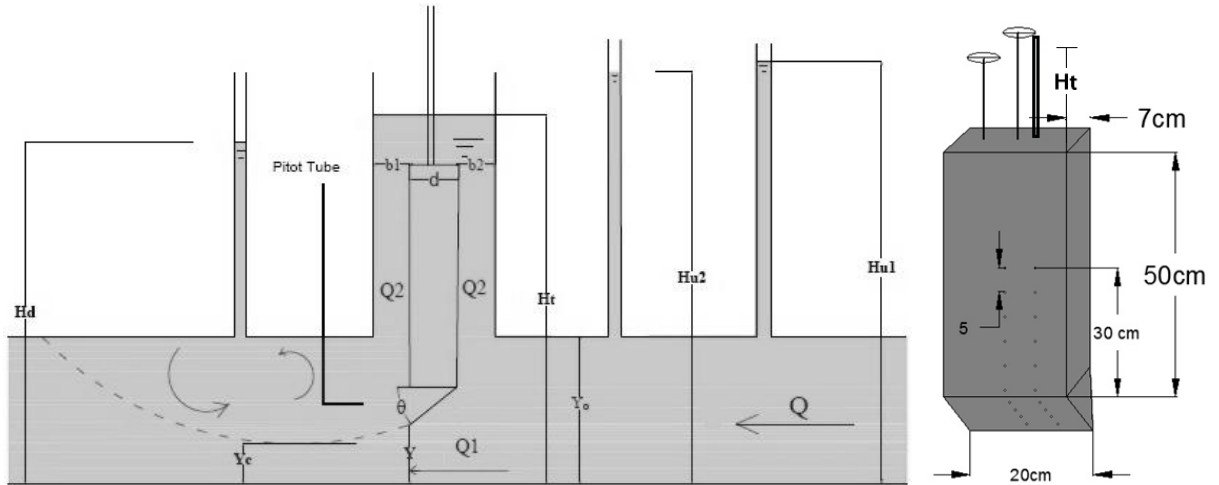

FIGURE 1. Scheme layout of hydraulic model with gate geometry

The improvement of small scale laboratory modeling was achieved to provide a convenient facilities, so that, the measurements were well done and cover a wide range of cases. The major measurements include different water discharges through the channel which regulated by using the valve, average pressure head on the top gate surface ,upstream and downstream pressure heads and jet velocity beneath the gate. All measurements were created with different inclined lip gate shapes and gate openings. The schematic layout of hydraulic model is shown in figure (1) .The gate model was made by a thick plate with a thickness of 6 mm and supported by steel frame slides in vertical way of the gate shaft, and two screws were provided on the top cover of gate shaft to adjust the inclination of the lip gate bottom and gate openings.

## 2. RESULTS AND DISCUSSION

The top pressure coefficient ( $K_t$ ) can be expressed as following (Naudascher 1964):

$$K_t = \frac{1}{B \cdot d} \int_0^d \int_0^B \left( \frac{H_t - H_d}{v_j^2 / 2g} \right) \cdot dB \cdot dx \quad (2)$$

Where

$B$ =Gate width, m

$d$ = the gate thickness and

$V_j$ = jet velocity below the gate

Since the distribution of the piezometric head ( $H_t$ ) on the top surface of the gate is approximately constant as observed through the experiments, equation (2) can be reduced to be:

$$K_t = \left[ \frac{H_t - H_d}{V_j^2 / 2g} \right] \quad (3)$$

As shown in the equation (3), the calculation of ( $K_t$ ) is based upon the measurements of the piezometric head on the top surface of the gate ( $H_t$ ), piezometric head downstream of the gate ( $H_d$ ), and the mean jet velocity below the gate ( $V_j$ ). The measurement of ( $H_t$ ) is made by a piezometer installed on the top surface of the gate, many readings were taken and the average value was adopted.

Figures (2) , (3) and (4) shows the relation between the gate opening ratio ( $Y/Y_o$ ) and ( $K_t$ ) for different gate lip shapes. It can be seen from the figures that the values of ( $K_t$ ) are decreasing when the gate openings are increasing ,however ,the general variations of ( $K_t$ ) are moving with similar trend .It can be seen from figure (2) that the values of ( $K_t$ ) are dropped fastly up to ( $Y/Y_o=0.5$ ) and thereafter being varied with small interval difference .The ( $K_t$ ) values for gate lip shapes with inclination angles ( $\theta=30^\circ$  and  $\theta=15^\circ$ ) are higher than those produced with other shapes considered, where ( $K_t$ ) values for lip gate shape with ( $\theta=20^\circ$ ) are less and for ( $\theta=25^\circ$ ) are more less.

Figure (3) indicates that the ( $K_t$ ) values are decreased clearly up to ( $Y/Y_o=0.5$ ) and then become more closed and uniform .However , no big differences in values of ( $K_t$ ) are observed beyoned midpoint of gate opening ratios.

As it can be noticed from Figure (4) that for big angles, the change in values of ( $K_t$ ) were occurred rapidly up to ( $Y/Y_o=0.6$ ) and then becomes less and very closed near high opening ratios.

### 3. CONCLUSIONS

The evaluation of top pressure coefficient is based upon exprimental works were carried out by using laboratory hydraulic model .The major achieved measurements were Upstream and downstream heads,top pressure head and velocity issuing beneath the gate.Many incline lip gate shapes with different angles were used for each gate openings ratio and the results of analyses are compared .according to the results ,the following conclusions are observed:

The values of top pressure coefficients are inversly propotional with gate opening ratios.

All the inclined lip shapes are mostly produced the similar trend of ( $K_t$ ) variations with different values of gate opening ratios and the turning point of changes indicated between ( $Y/Y_o=0.5$  and  $Y/Y_o=0.6$ ).

The big values of ( $K_t$ ) were obtained for lip gate shape with ( $\theta > 50^\circ$ ) and consequently ,the values of downpull force may also be increase .

As checked by the principles of regression ,the ( $K_t$ ) profiles can be represented by polynomial function with high values of correlation coefficeint.

**REFERENCES**

- [1] Ahmed, T. M., “Effect of Gate Lip Shapes on the Downpull Force in Tunnel Gates”, Ph. D Thesis Submitted to the College of Engineering, University of Baghdad, 1999.
- [2] Al-Kadi, B. T., “Numerical Evaluation of Downpull Force in Tunnel Gates”, Ph. D Thesis Submitted to the College of Engineering, University of Baghdad, 1997.
- [3] Almaini, R. M., Al-Kifae, M. T., and Alhashimi, S. A. M., “Prediction Downpull Force on Tunnel Gate with Different Gate Lip Geometry”, Journal of Kerbala University, Vol. 8, No.4, 2010.
- [4] Andrade, J. L., and Amorim, J. C., “Analysis of the Hydrodynamic Forces on Hydraulic Flood Gates”, AIAA Journal, Vol. 21, No. 10, 2003.
- [5] Brankovic, J. M., and Drobier, H., “New High Head Leaf Gate Form with Smooth Upstream Face”, TEM Journal, Vol. 2, No .1, 2013.
- [6] Colgate Donald. "Hydraulic Down pull Forces on High Head Gates", ASCE HY 11, November, (1959).
- [7] Drobir, H., Volker, K., and Johannes, S., “Downpull and Tunnel Type High Head Leaf Gates”, Iahr/Airh Hydraulic Report, Balkema, Rotter Dam, 2001.
- [8] Elder, R. A. and Garrison, J. M., “Flow Induced Hydraulic Forces on Three Leaf Intake Gates”, ASCE, Vol. 90, No. 3, 1964.
- [9] Naderi, M. N., and Hadipour, E., “Numerical Simulation of Flow in Bottom Outlet of Narmashir Dam for Calculating of Hydrodynamic Forces”, European Journal of Applied Engineering and Scientific Research, Vol. 2, No. 2, Pp. 33-40, 2013.
- [10] Naudascher, E., “Hydrodynamic Forces”. IAHR, Structure Design Manual, International Association of Hydro Research, Stockholm, Sweden, 1991.
- [11] Naudascher, E., Kobus, H. E. and Rao, R.R., “Hydrodynamic Analysis for High-Head Leaf Gates”. ASCE, Journal of the Hydraulic Division. Vol. 90, No. 3, Pp. 155- 192, 1964.

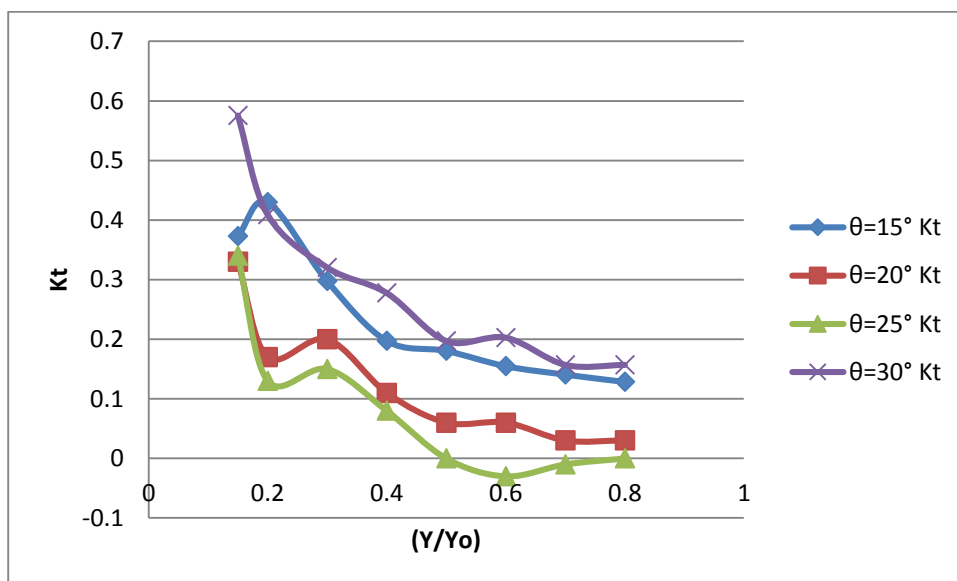

FIGURE 2 . Variation of top ppressure coefficient with gate Openings for different gate lip shapes

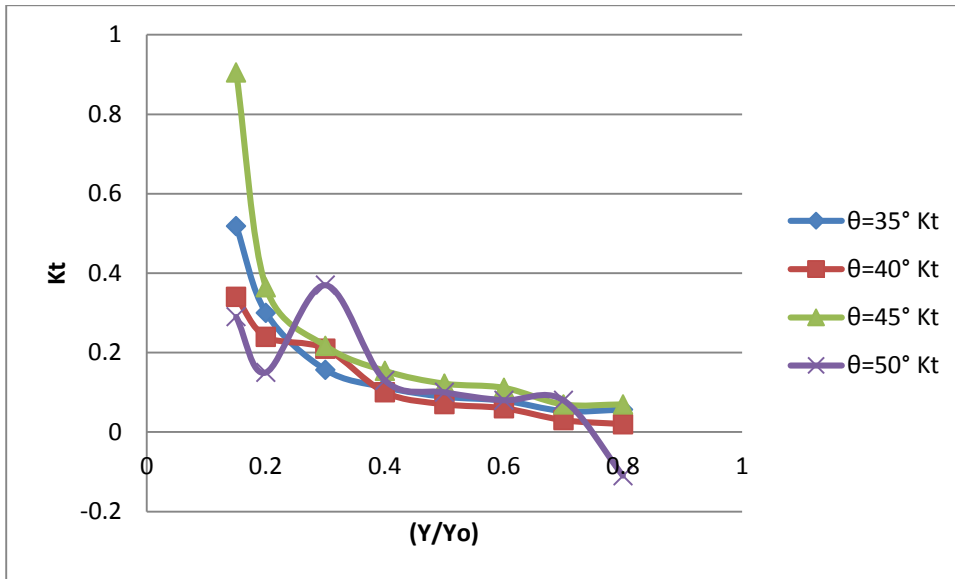

FIGURE 3 . Variation of top pressure coefficient,with gate Openings for different gate lip shapes

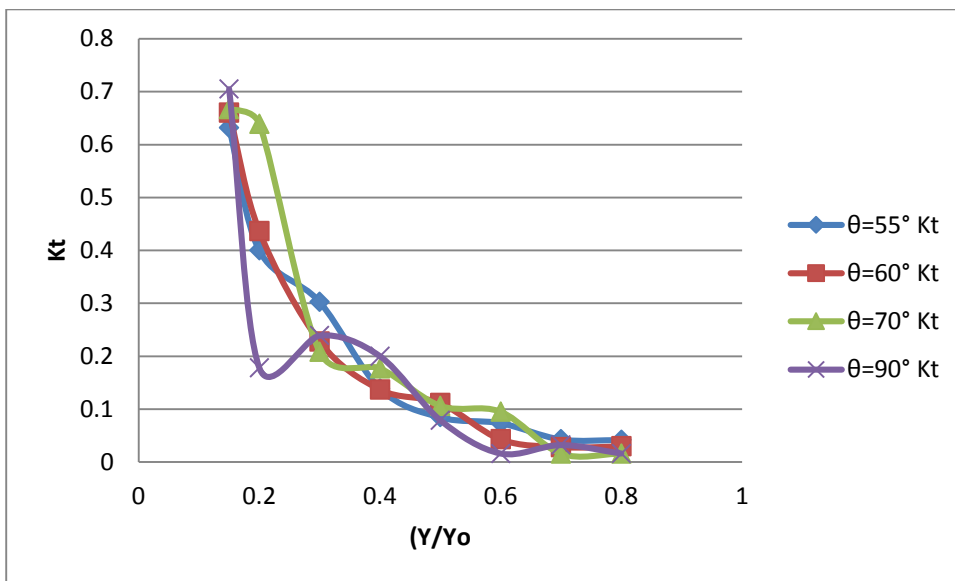

FIGURE 4 . Variation of top pressure coefficient with gate Openings for different gate lip shapes

## **Environmental Pollution and Impacts of Dust Storms on the Traffic Safety**

Assist.Prof. Amera I. Hussain<sup>1</sup>, Eman L. Salman<sup>2</sup>

<sup>1</sup>Tikrit University, College of Science, Applied Geology Dept., Tikrit, Iraq

<sup>2</sup>Department of Civil Engineering, Ishik University, Erbil, KRG-Iraq

<sup>1</sup>amera\_hussain@yahoo.co.uk, <sup>2</sup> eman.lafta@ishik.edu.iq

### **ABSTRACT**

The study aims to investigate the negative effect that the dust storms leave on the human health in general and on the traffic safety as well. Five represented samples of the dust have been collected from the storms which occurred during (2009 and 2010) in Tikrit city/ north of Iraq to find its particle size distribution, existence of heavy metals, and radioactive minerals, in addition, a survey that consists from 70 samples has been collected to examine the driving difficulty during such condition.

Grain size analysis show that the silt size forming the majority (62.6% ), fine sand (23.52%) and clay (13.88%) , also CaCO<sub>3</sub> and organic content have been determined with average (25.9%) and (2.11%) respectively. The heavy metals including Cd, Ni, Pb, Cr, Co, and Zn showing that Zn, Ni, Co and Cr are more than the standards in the crust of the earth which considered pollutant elements while Cd and Pb are less than the standards. It was found that 92% of the drivers face difficulty during driving in dusty weather, 47% of the drivers has health problems concerns the dusty weather and 20% of them tend to change their destination or drive faster when they face dust storm while driving.

**Keywords:** Dust storms, Heavy Metals, Traffic Safety, Air Pollution.

### **1. INTRODUCTION**

Tikrit city is located in the north of Iraq and west of Tigris River and bordered by wadi Tharthar on the west (Figure 1). During major dust storms, the deposition of dust over populated areas can be wide reaching, often affecting multiple cities and towns. Dust storms can take down trees, bury equipment and cause damage to houses and people started suffering from "dust phenomena" and long-term health concerns have cropped up recently. This is primarily due to the increased number of storms originating from areas of desertification. The dust in these storms has been shown to contain pollutants and toxins, such as salt, sulfur, heavy metals, pesticides and carbon monoxide (Batjargal, Z. 2004) . The pollution-laden dust can be carried over hundreds of miles, affecting millions of people who might not necessarily suffer from the acute events of the storm.

The dust storms in Iraq increased during the last twenty years gradually as a result of the climate change and the decrease of annual precipitation and the increase of temperature. The area of study characterized by poor vegetation cover and increase in the area of deserts as a result of drought long summer season and unreasonable exploitation of agricultural lands.

Dust storms can lead to serious traffic problems especially when it has high intensity; there are three elements for the traffic which are Vehicle, human element



(passenger and pedestrian) and road). 86% from the traffic accidents happens due to the human element, while 9%, 4% and 1% are due to the vehicle, environmental factors and road respectively (TEC 2003).

## 2. AIM OF THE STUDY

1. Study the physical properties of the dust which included the specific gravity and the grain size distribution.
2. Determination of the main heavy metals including Cd, Ni, Pb, Cr, Co, and Zn and comparing their concentration with the standards of the elements in the crust of the earth.
3. Determination of the level of radiation in the dust samples.
4. Study the effect of dust storms on the safety three aforementioned traffic safety elements.

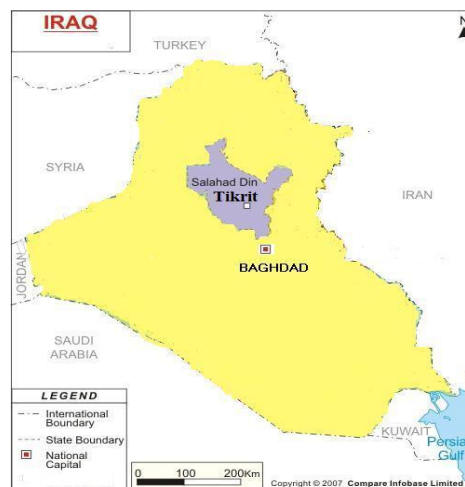

FIGURE 1. Location map of the study area

## 3. METHODOLOGY AND RESULTS

### 3.1. SPECIFIC GRAVITY

Two samples have been collected during the main dust storms which occurred in May/2009 and July/2010, the specific gravity (Gs) of the samples were determined according to [ASTM C-127-88] which are 2.67 and 2.69 respectively.

### 3.2. HYDROMETER ANALYSIS

For determining the particle size of the dust particles, two samples were collected from different places in the city of Tikrit by placing containers for collecting the dust and in the end of the storm the retained dust were analyzed by hydrometer according to [ASTM C127-88], and found that the particle size distribution containing 23.52 % of fine sand, 62.6% silt and 13.88 % clay, and also the percentage of organic material is 2.11%. , the fine particles more effect on the health because the heavy metals is associated with it [ Kabata, 2011].

### 3.3. RADIOACTIVITY TEST

This test was carried on for the two samples of dust by Giger counter device in the laboratory of the Physics Department – College of Science in Tikrit University. The test method is concluded by measuring the background radiation of the laboratory without the same for a certain period (1 minute) for two readings which is subtracted from the dust sample radiation, the samples were tested in three states for measuring Alpha, Beta and Gamma ray. The three states were (a) with cover, (b) without cover, and (c) cover and barrier. Table 1 shows the results of background radiation; Table 2 shows the results of the samples.

TABLE 1.  
The result of background radiation

Radiant 1 (R1)	Radiant 2 (R2)	$\Sigma$ R1 + R2
12	18	30

TABLE 2.  
The result of samples radiation

	Sample (1)			Sample (2)		
	Radiant 1	Radiant 2	$\Sigma$	Radiant 1	Radiant 2	$\Sigma$
With cover	18	16	34	23	22	45
Without cover	25	15	40	20	21	41
Cover+barrier	13	16	29	16	14	30

The concentration of each radiated element in the dust samples was evaluated and the results are shown in Table 3.

TABLE 3.  
The concentration of radiated elements in the dust samples

Radioactive elements	Sample (1) (Bg)	Sample (2) (Bg)
C <sub>60</sub>	3.0	5.0
Cs <sub>132</sub>	2.0	2.0
Cl <sub>36</sub>	3.0	4.0
Am <sub>241</sub>	3.5	4.0
Sr <sub>90</sub>	0.5	0.0
U <sub>238</sub>	0.0	1.5
C <sub>14</sub>	11.5	10.0

### 3.4. HEAVY METALS

Heavy metal contamination of environment is a worldwide phenomenon that has attracted a great deal of attention. Heavy metal contamination of soil resulting from wastewater irrigation is a cause of serious concern due to the potential health impacts of consuming contaminated products. Studies of heavy metals in different areas in the world concludes that the origin of the heavy metals is the source rocks which are rich in these metals or from contaminated soil and sediments by industrial water or polluted water.[Abirami et.al,2015]and[Vega,2007]. The presence of heavy metals in soil increases as a result of adsorption or absorption by fine sediment particles as clay particles, and the increasing of these metals existence indicates the multi sources [Senwo and Tazisong, 2004]. The test results for the samples are shown in Table 4.

TABLE 4.  
Concentration of the different heavy metals in the studied samples

Sample No.	Cd ppm	Co ppm	Cr ppm	Pb ppm	Ni ppm	Zn ppm
Sample (1)	Less than 5	Less than 25	102	Less than 25	116	67
Sample (2)	Less than 5	Less than 25	106	Less than 25	123	59

Following are the details of the investigated elements:

1. Cobalt Co:

The average of Co about (25 ppm) in the studied samples, while in the upper part of the earth crust is (10-12 ppm) [ Alumaa et al.2002] the high concentration of Co may be due to the nature of the source rocks such as basic and ultra-basic rocks and also due to the absorption of the element on the surface of fine sediment particles.

2. Nickel Ni:

The concentrations of this element in the earth crust are due to the source rocks and increase in the fine sediment such as mudrocks [Park 2003] and [Kabla 2011]. The concentration of Ni in the studied samples are between (116-123 ppm) with an average of 119.5 ppm. The high concentration may be due to the source sediment rich in organic material or due to source rocks and considered one of the most pollutant material.

3. Lead Pb:

The average of Pb in the studied samples is (25 ppm) and considered less than the standard in the earth crust which is 70 PPM [Alumaa et.al 2002].

4. Zinc Zn:

The average of Zn in the earth crust is about 70ppm while in the mudrocks that is rich in organic material is about 120ppm [Prusty 2008]. In the studied samples the concentration is between (59-67 ppm) with average of 63ppm, the high concentration may due to the organic materials in the source sediment.

5. Cadmium Cd:

One of the most poisoned metals for the human being and maybe increased in the sediment and soil which is derived from many sources such as manufactured

materials. The average concentrations of Cd in the studied samples are about 5 ppm and that is below the standard of the element in the earth crust.

#### 6. Chrome Cr:

The average of Cr in the studied samples was 104 ppm and the concentration is higher than the standard in the earth crust that might due to the source rocks or source sediment.

### 3.6. SURVEY

A survey included 70 random samples of drivers has been performed to study the effect of dust storms on driving performance and the driver health. The questionnaire covered the following questions:

1. Did you ever experience difficulty in driving in dusty weather?
2. What was the minimum distance of vision you experienced due to dust storms?
3. How many times you had to stop the vehicle due to sudden dust storms?
4. Did you ever experience any driving incident during dust storm?
5. Do you have health problems related to dust?
6. Did you have to change your destination or accelerate the speed due to dust storms?
7. Does the dust storm ever harm your vehicle performance? Or the air filters that lead to the engine or the water sprinkles on the windows?
8. What do you usually do if you faced severe dust storm while driving?

The survey also included other questions related to number of years of driving experience, gender, places of driving...etc.

The results showed that 92.8% of the drivers had experienced some difficulty while driving, 58% experienced a minimum range of vision less than 5 meters while driving in heavy dust storm while 8.5% experienced minimum range of vision more than 30 meters. Only 14% of the drivers tend occasionally to stop their vehicle during the storm. 70% of the drivers agreed that the dust storms had harmed their vehicle in several ways and 47.1% said that they have health problems and breathing difficulties due to the dust storms.

### 4. CONCLUSIONS

1. The results of the heavy metals show that the concentration of Zn, Ni, Co and Cr are more than the standards in the crust of earth therefore are considered as pollutant elements.
2. It was found that the particle size distribution containing 23.52 % of fine sand, 62.6% silt and 13.88 % clay, and also the percentage of organic material is 2.11%.
3. Cd and Pd concentrations are less than the standards in the earth crust therefore they have no effect on the environmental conditions.
4. According to the results of the radioactive background it was found that  $C_{14}$  in the studied samples has high level of radiation.
5. It was found that more than 92.8% from the drivers face difficulty in driving during dust storms. Only 14% of the drivers tend to stop the vehicle in case a dust storm occurred.

## REFERENCES

- [1] Alumaa P., Kirso U., Petersell V., Steinnes E. (2002): Sorption of toxic heavy metals to soil: Short Comm. *Int. J. Hyg. Environ. Health* 204:375–376.
- [2] Al-Jeboury, A.N.M., 2002, Geographical Analysis of climate elements in Salah a Din province, Unpublished MSc. Thesis ,College of Education, Tikrit University.
- [3] Batjargal,Z. 2004, Yellow Dust Storm Is Indication Of Unhealthy Environment In Asia, Report on Security outlook in northeast Asia and new agenda for the Kanazawa process, Mongolia.
- [4] Kabata, P. A. ( 2011): Trace elements in soils and plants, 4<sup>th</sup> edition, Published by Taylor & Francis Group, 505 p.
- [5] Park, Min Ha, Kim, Yong Pyo and Kang, Chang-Hee, 2003, Aerosol composition change due to dust storm ,measurements between 1992 and 1999 at Gosan, Korea, *Water, Air and Soil Pollution: Focus* 3, 117-128.
- [6] Prusty B.A.K., Chandra R., Azeez P.A. (2008): Vertical and temporal variation of Zn in the soils of a multiple habitat system. *J. Food Agric. Environ.* 6:381–387.
- [7] Senwo Z.N., Tazisong I.A. (2004): Metal contents in soils of Alabama. *Commun. Soil Sci. Plant Anal.* 35:2837–2848.
- [8] Sumner M.E. (2000): *Handbook of Soil Science*. Taylor & Francis, Boca Raton, FL.
- [9] Tejada M., Moreno J.L., Hernandez M.T., Garcia C. (2008): Soil amendments with organic waste reduce the toxicity of nickel to soil enzyme activities. *Eur. J. Soil Biol.* 44:129–140.
- [10] Vega F.A., Covelo E.F., Vazques J.J., Abdrade L. (2007): Influence of mineral and organic components on copper, lead and zinc sorption by acid soils. *J. Environ. Sci. Health. Part A-Toxic/Hazard. Subst. Environ. Eng.* 42:2167–2173.
- [11] Abirami, L., Mohamed Sirajudeen, A, Ravichandran, R. and Rengarajan, R. (2015) *International Journal of Current Research*, Vol. 7, Issue, 08, pp.19430-19435.
- [12] TEC 2003. *Traffic Engineering & Control* June 2003, page 200. Hemming Group.
- [13] American society for Testing and Materials ASTM C-127-88, 2004 Standard Test Method for specific gravity, volume 1p1-5.

## **Applications Of Geographic Information Systems In Construction Management**

Cemil Akdeniz

*Department of Civil Engineering, Ishik University, Erbil, KRG-Iraq  
cemil.akdeniz@ishik.edu.iq*

### **ABSTRACT**

Construction management is one of the fields of Civil Engineering. It includes planning, analyzing, coordinating and controlling of sequential activities in construction site. The primary goals of construction management are to minimize the loss of time and construction costs by appropriate materials, adequate labor and resource selection. These objectives can be achieved by current and updated continuous information flow between participants and departments of construction organization. When information sharing doesn't happen effectively and timely it results delays and additional costs at the construction projects. Information technology has become prominent position in the development of technology. It supplies some opportunities to construction industry. One of the important parts of information technology is geographic information systems. It provides effective solutions to the locational based problems so they are used in many areas. The possibilities of using GIS in construction management and new models have been developed in various countries in the world in recent years. In this study, using GIS in construction management is investigated and a new method in construction management is tried to develop by use of GIS. Another aim is to supervise all data related with construction on a single platform. A new office block in Erbil is determined as a case study. Project drawings of the building are brought to three-dimensional form in GIS and it is visualized according to the data in the schedule of construction. Database support and visualization feature of GIS is put forward in this paper.

**Keyword:** Construction Management, Information Technology, Geographic Information Systems.

### **1. INTRODUCTION**

Civil engineering is one of the leading branches of engineering. It includes many fields which have extensive research and applications areas. One of these fields is construction management. Construction management involves design and application of activities through planning, coordinating and control. Continuous flow of accurate and updated information between departments and individuals is an important task during these activities. Solutions of traditional methods to information-based problems of construction project are inadequate. Therefore, it is considered that, the developed information technology is essential to use in phases of a construction project. [1]

When it was realized that information management has the key function in construction management, it has resulted the widespread use of information technology in this field. GIS supplies less regulation and drawing function according to CAD technology nevertheless it provides database and spatial analysis functions for constructions. GIS have been used in geotechnical engineering, hydrology and transportation areas for many years but use of GIS in construction management has become remarkable research area in recent years.[2]

The study fields of construction management are database management, construction site design, material and cost management, route determination, real-time project tracking, 3D and 4D projections. They may be designed by using GIS applications. [3]

The essential information for design and planning are saved in different format, such as bar charts, specifications and drawing in construction industry. The information in planning has to be organized repeatedly which is taken from different resources. This process is dull and inclined to error. Thus, a system is needed in construction industry which is capable of combining different data kinds and supplies the essential data and information on time which will promote different construction operations in the end. GIS is a new instrument in information technology. It increases design efficiency and planning by combining thematic and spatial information in an all-in-one platform. [4]

An extensive range of information can be supplied to the construction industry by the construction database. Using GIS may provide the need of descriptive and spatial information which is needed in different construction process. Sun and Hasell developed the prototype system in 2002. It recommends that real time spatial data supplies precise and rapid visual data regarding to the improvement on the construction site. Effective management control systems can be supplied by the combination of spatial database and project management functions. [5] In order to produce a 3-D subsurface environment of boreholes, Camp and Brown proposed using capacity of GIS's database management in 1993. The construction method, scheduling of project and choice of equipment are affected by the surface and subsurface conditions. For this reason project team should properly specify site conditions. [6] Oloufa et al benefited a database to save the illustrative data of soil in GIS. They used it to show the boreholes locations on the map in 1994. [7]

Quantity takeoffs and cost estimation based on GIS was proposed by Cheng and Yang in 2001. In that method, they used several layers called data layers for their divided architectural drawing. They used area, quantity takeoffs and perimeter as the parameters. In this way, they transformed data layers to CAD as polygons and adopted as geometric coverage to Map/Info. Spatial information involves some features like area, spatial relationship, perimeter and coordinate. [8] However, thematic information involves floor number, identification code, beam number etc. The user enters this information. Locational and thematic information are combined by using relationships. They are accomplished by Open Database Connectivity (ODBC). Spatial processes are applied. So that essential dimensions of the graphical properties are specified. Parameters like area of windows and door, floor height, beam depth and slab are entered

to complete the quantity calculation. They used Structured Query Language to meet the information of quantity takeoffs. They were taken the related feature tables. For dynamic materials requirement plan, the material plan combines material estimates with construction schedule. They designed the system to transfer data directly to the site to arrange materials. The suggested methodology specifies the appropriate site to keep the materials by the information concerning locations and quantities of the materials desired in the project. [9]

Cheng and O'Connor stated that the manager of the project must be continually informed from different resources and sketch it on the paper in temporary facilities scheme. Short-term facilities should be established as near as to their supportive operations in order to decrease travel time. An automated site layout system was built up by Cheng and O'Connor which is called ArcSite based on GIS for short-term facilities of construction. It includes GIS which is integrated with database management system to assign available areas for location of short-term facilities. ArcSite gets data needed to find appropriate place. Then it makes complicated spatial operations and database enquiries to show ideal site. [10]

All of these studies have showed that construction industry needs a tool which is responsive to spatial problems and makes the knowledge management easy. Traditional methods cannot meet the spatial needs of construction projects; therefore delays and additional costs occur. In this respect, investigating of the use of GIS which is an effective management tool for the spatial solutions is very important for construction industry. [11]

In this study, using GIS in the construction management is researched and a new approach is tried to bring. GIS aided construction management applications briefly mentioned and animation based management structure is proposed. 3D animation based project tracking is specified and the new building was chosen as the case study. The architectural and technical design drawings are transformed into 3D layers in a GIS environment which represents project tasks. Tasks on the schedule are presented as animations according to the completion date. All qualitative and spatial data related with labor, materials, equipment, etc. are collected and combined in a single environment.

## **2. METHOD**

To produce three dimensional perspectives in GIS, architectural drawings are not enough; therefore they are separated into some layers. The aim is to establish exactly how layers indicate the complete three dimensional perspectives in GIS. So CAD based drawings are transferred to GIS environment in this study. Spatial coordinate system is assigned for the layers which are in the cartesian coordinate plane in CAD software. Thus drawing layers become spatial data. Then, 3D view is obtained by adding base height and extension data to the layers.

In the proposed animation based system, real-time data is required for monitoring the project. Therefore CPM- based (Critical Path Method) schedule is prepared. Labor, material and equipment data of the building I n the case study is collected and entered



spatial database. The spatial database of GIS makes possible of all data in a single environment to store. Eventually, 3D layers and qualifications are merged in the GIS software interface and presented as animation based.

### 3. DATA USED

The new office block in Erbil is defined as a case study for GIS-based construction management system. Architectural project drawings in AutoCAD environment were utilized on the visualization as a 3D structure stage. Foundation work, concrete work and masonry work are dealt with to prepare the project schedule. Start and finish dates of tasks are determined. Data related with labor, materials, equipment, etc. is used in the system.

### 4. SYSTEM STAGES

In the proposed GIS-based system, 3D visualization feature of GIS is used to manage the spatial and qualitative data of construction in a single environment. System frame is given below in figure 1. The system includes 3D visualization, preparation of project schedule, and design of database by saving qualification data on tables. In the end, animation based application is provided. Information about these stages will be presented in the following part.

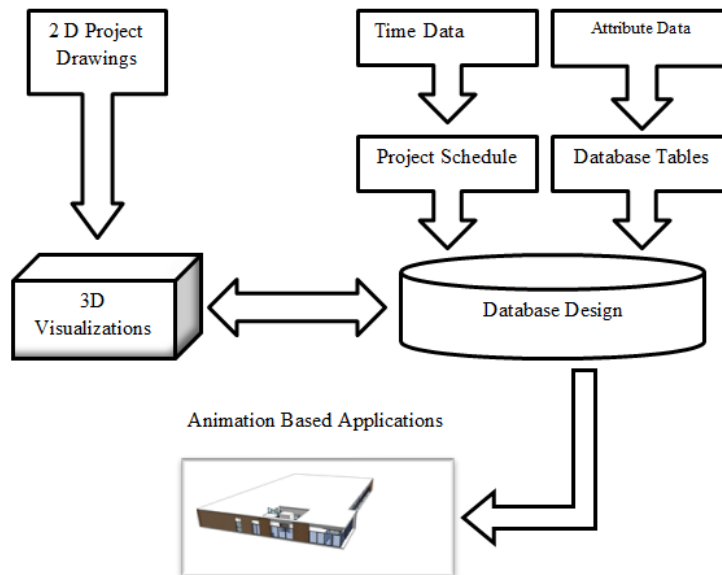

FIGURE 1. System Frame

GIS software is an effective tool for visual representation of 2D and 3D data in layers form and spatial based analysis. In this study, ArcGIS is used as GIS software. Architectural drawings which are prepared in Sketch-up Professional are transferred to ArcGIS environment by converting them to data layers which are represented project tasks. Because of the data layers don't have any geographic coordinate system; a geographic coordinate system is assigned to those layers. Later the layers are presented

in the ArcGIS as 3D. In figure 2, columns and beams of the ground floor are shown as 2D and 3D.



FIGURE 2. (a) 2D view of ground floor, (b) 3D view of ground floor

## 5. DATABASE DESIGN

### a. Preparation of project construction schedule

There are many sequential and simultaneous phases in construction projects. A CPM-based scheduling is prepared to show start time, finish time and duration of each task of rough construction. For construction scheduling, some project management software is available. In this study construction scheduling is prepared in GIS. GIS software is available for storing data in tables. Those tables have data fields such as the start and end nodes of each task, start and completion dates and duration of each task. Foundation and concrete work is sequential at building constructions. However, concrete and masonry work is performed simultaneously for some tasks at upper floors.

### b. Inserting attribute data into the tables

Many data is available at construction projects which has sequential and simultaneous applications. Storage, analysis and management of large amounts of data become a problem at construction projects. For this reason in the study, a database is designed which has construction qualifications and relation between data groups. Each set of data is stored separately in tables. In this way, data enquiry and management can be done easily by storing them in a single environment.

## 6. ANIMATION BASED APPLICATIONS

Animation based applications are made by using ArcGIS. In this study, a layer animation depends on the time data is carried out for the model construction. Construction layers are saved separately in files as animation frame. Start and finish time of each layer is determined which is associated with the construction schedule. In this way, they can be followed by the time scale. 3D animations are obtained by the combination of visual layers of work tasks. In figure 3, 3D layers of foundation, basement, concrete and masonry work of the building is shown as animation-based.

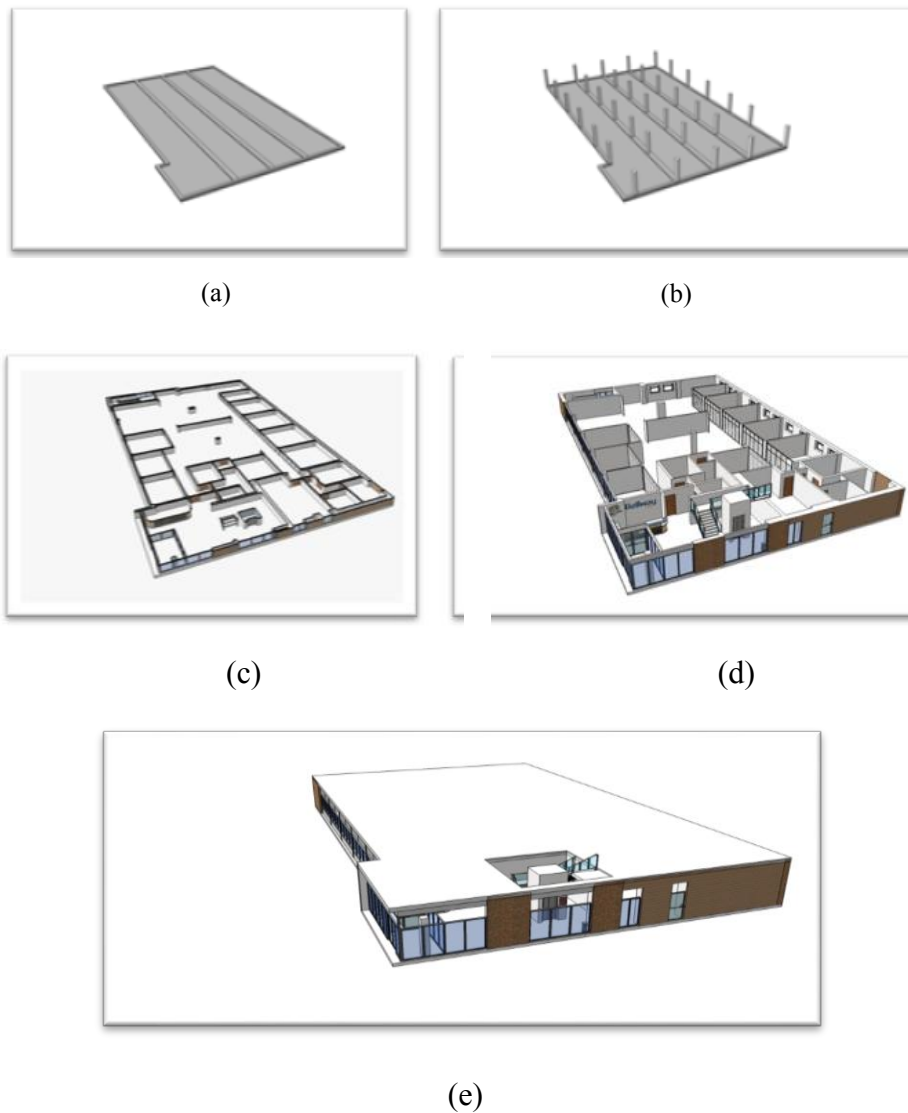

FIGURE 3. 3D animation frames: (a) the Raft foundation, (b) the basement columns, (c) the ground floor overview, (d) Internal details, (e) a bird-eye view.

## 7. CONCLUSION AND RECOMMENDATIONS

In this study, a GIS-based construction management is issued. An innovative perspective is brought to the traditional construction management methods. Some studies in this area are referred briefly and GIS-based management model is proposed. GIS is a major part of information technology. Beside this, it has spatial feature. It makes it as an effective tool for construction industry. Animation-based project tracking method is used and applied to the new building. ArcGIS is used as GIS software. The study includes 3D visualization, preparing of project schedule, database design and animation based applications. 3D visualization phase is done in the ArcGIS, animation of model structure is carried out. It has been resulted that GIS is an effective management tool for construction projects in terms of database support and

visualization. The established system provides project managers to determine the stages of construction in 3D and possible delays. Integrated schedule and design information makes easier to control the construction progression. For example, dynamic material requirements can be developed by using this integration. Also, one of the most fundamental problems in construction management process is data management. It can be achieved in a single environment by the support of developed database of GIS. Nevertheless, the CAD technologies supply visualization qualifications, varied operations on the characteristic data matched with the three dimensional model can be achieved by GIS, that isn't available in CAD, yet.

## REFERENCES

- [1] EMRE CENGİZ, YUCEL GUNEY (2011). "Cografi bilgi sistemleri tabanlı bir yapı yönetimi önerisi"
- [2] BANSAL, V.K., PAL, M. (2009). "Construction schedule review in GIS with a navigable 3D animation of project activities. "International Journal of Project Management, 27, p. 532-540
- [3] CLARK, K. (2001). Getting Started with Geographic Information Systems, Upper Saddle River, Prentice Hall N.J.
- [4] VARGHESE, K., and O'CONNOR, J.T. (1995). " Routing large vehicles on industrial construction site." Journal Construction Engineering and Management, ASCE, 121 (1), 1-12.
- [5] SUN, W., HASELL, M.J. (2002). "Exploring a GIS prototype to improve the management of the architectural design, engineering and construction building product process. "Environment Science and Research Institute (ESRI) Conference
- [6] CAMP, C.V., and BROWN, M.C. (1993). "GIS procedure for developing three-dimensional subsurface profile." Journal of Computing in Civil Engineering, ASCE, 7 (3), 296-309.
- [7] OLOUFA, A. R., ELTAHAN, A. A., and PAPACOSTAS, C. S. (1994). "Integrated GIS for construction site investigation." Journal Construction Engineering and Management, ASCE, 120 (1), 211-222.
- [8] CHENG, M.Y., and YANG, C.Y. (2001). "GIS-Based cost estimate integrated with material layout planning." Journal Construction Engineering and Management, ASCE, 127 (4), 291-299.
- [9] LI, H., CHEN, Z., YONG, L., and KONG, S.C.W. (2005). " Application of integrated GPS and GIS technology for reducing construction waste and improving construction efficiency" Automation in Construction, 14, 323-331.
- [10] CHENG, M.Y., and O'CONNOR, J.T. (1994). "Site layout of construction temporary facility using enhanced-Geographic Information System (GIS)." Automation in Construction, 3, 11-19.
- [11] JELJELI M. N., RUSSELL, J. S., MEYER, H. W. G. and VONDEROHE, A. P. (1993). "Potential applications of geographic information systems to construction industry." Journal Construction Engineering and Management, ASCE, 119 (1), 72-86.

## **Effect Of Increasing Columns Concrete Strength On Columns Reinforcement Ratio In High Rise Buildings**

Prof. Dr. Bayan S. Al-Nu'man

*Department of Civil Engineering, Ishik University, Erbil, KRG-Iraq  
bayan.salim@ishik.edu.iq*

### **ABSTRACT**

This work presents a theoretical study on the effect of using concrete with different strengths for columns on the structural behavior of integrated RC building frames. Eight-story reinforced concrete frame was analyzed employing a StaadPro program for the structural analysis of building. The obtained results indicated that under static loading, variation in the concrete strength of the columns has a negligible effect on the behavior of the studied frame. However, The values of reinforcement ratio has been changed significantly when the column concrete strength is changed from 28 MPa to 56 MPa, and to 84 MPa.

**Keywords:** Concrete Columns, Concrete Strength, Reinforcement Ratio.

### **1. INTRODUCTION**

The use of high-strength concrete for high-rise buildings has become popular due to development in concrete technology and availability of various types of mineral and chemical admixtures. High-strength concrete (HSC) could lead to smaller member sizes for compression members and therefore provide considerable savings associated with material costs and reduction of dead loads<sup>(1)</sup>.

From the economic standpoint, combination of high and normal strength concrete (NSC) in building construction is becoming common practice, where HSC is used for columns and NSC is used for the surrounding beams/slabs floor system<sup>(2)</sup>. This creates a situation where concrete strength of the column portion at the beam/slab floor level is lower than concrete strength used for rest of the column.

ACI Committee 363<sup>(3)</sup> defined HSC as a concrete of minimum strength of 6 ksi (41 MPa). More recently, compressive strengths approaching 20 ksi (138 MPa) have been used in cast-in-place buildings. The material properties of high-strength concrete differ from those of normal strength concrete in many ways. In addition to higher concrete strength, Higher elastic modulus, i.e., greater stiffness; Higher tensile strength, Increase in the strain at maximum stress and Steeper descending part of stress-strain curves are other significant features of high-strength concrete.

## 2. SCOPE AND AIM OF WORK

In this work, theoretical investigation of the Moment, Shear, Axial Forces are conducted by using computer program (Staad Pro 2007 V8i) for the columns of an eight-story reinforced concrete frame located in Erbil, when the concrete compressive strength of the columns of the first two floors is changed from 28 MPa to 56 MPa and 84 MPa.

The main purpose of the project is to determine the advantages and disadvantages of the change in concrete compressive strength of the columns of the first two floors, and this will be done by examining the change in moments, shear, axial and design of the columns, which will give the researcher a certain knowledge in order to determine which stage will be the optimum choice for building in order to get the best column design by considering the optimum columns sizes and steel percentages.

## 3. CASE STUDY MULTISTORY BUILDINGS

An eight floor multistory residential building that has four housings in each floor located in Mamostayan City is investigated. Fig 1 shows typical floor plan with columns layout.

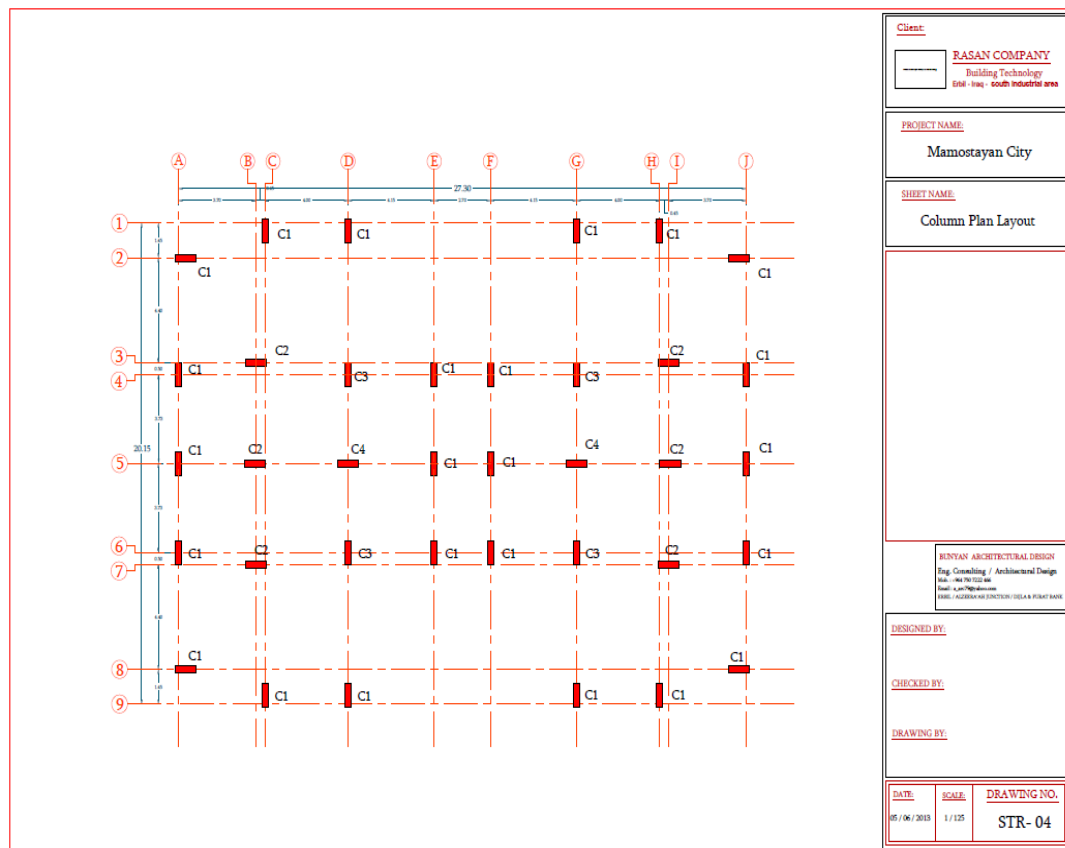

FIGURE 1. Typical floor plan with columns layout of the investigated building

#### 4. LOAD COMBINATIONS

The ACI Code <sup>(4)</sup> requires that structures be designed for a number of load combinations. Thus, for example, factored load combinations might include

1. Dead plus live load;
2. Dead plus fluid plus temperature plus live plus soil plus snow load;
3. Three possible combinations that include dead, live, and wind load
4. Two combinations that include dead load, live load, and earthquake load, with some of the combinations including snow, rain, soil, and roof live load.

While each of the combinations may be considered as an individual loading condition, experience has shown that the most efficient technique involves separate analyses for each of the basic loads without load factors, that is, a full analysis for unfactored dead load only, separate analysis for the various live load distributions, and separate analysis for each of the other loads (wind, snow, etc.). Once the separate analyses are completed, it is a simple matter to combine the results using the appropriate load factor for each type of load <sup>(5)</sup>.

#### 5. RESULTS AND DISCUSSION

Moments, shear and axial forces for all the structural members of the case study building had been conducted. The percentage of change in moments, shear and axial forces for the structural members is recorded when the compressive strength of the first and second floors has changed from 28 MPa to 56 MPa, and to 84 MPa. The same work has been done when the case study building has been subjected to wind loading of speed 108 km/h which is the case for Kurdistan wind zone <sup>(6)</sup>.

Based on the results presented in this chapter, the following findings can be listed:

1. Small changes in the values of the moments were found. Maximum column moment change was 7.69% when strength is changed from 28MPa to 84 MPa. In beams the corresponding maximum change was 7.34%.
  - a. When wind loading is introduced the percentage change in moments was maximum 8.8% percent when strength is changed from 28MPa to 84 MPa. In beams the corresponding maximum change was 10.4%.
2. Small changes in the values of the shear force were found. Maximum column shear force change was 6.35% when strength is changed from 28MPa to 84 MPa. In beams the corresponding maximum change was 3.72%.
  - a. When wind loading is introduced the percentage change in shear force was maximum 8.12% percent when strength is changed from 28MPa to 84 MPa. In beams the corresponding maximum change was 3.20%.
3. Small changes in the values of the axial force were found. Maximum column axial force change was 2.32% when strength is changed from 28 MPa to 84 MPa. In beams the corresponding maximum change was 11.76%. When wind loading is introduced the percentage change in axial force was maximum 5.99% percent when strength is changed from 28 MPa to 84 MPa. In beams the corresponding maximum change was 13.77%.

In addition, tables are presented also for the percentage of change in column steel ratios (Rho) when the columns compressive strength of the first and second floors is changed from 28 MPa to 56 MPa, and to 84 MPa.

The same work has been done when the case study building has been subjected to wind loading of speed 108 km/h which is the case for Kurdistan wind zone.

These are shown in design tables (without wind Tables 1 and 2, and with wind Tables 3 and 4). Figures 1 and 2 show the reduction of column reinforcement ratios as the compressive strength is increased from 28 MPa to 56 MPa and to 84 MPa for both analysis cases, i.e., without wind loading, and with wind loading.

Design of reinforcement was performed and the following points were recorded:

1. The values of reinforcement ratio for the case without wind loading has been changed significantly when the strength is changed from 28 MPa to 56 MPa, and to 84MPa. For the first floor column the Rho value has reduced from 4.28% to 1.25% (71%) to 1.0% (77%) for an interior first floor column No.106, corresponding to the said strength values. However for the eight floor column No.69, the corresponding values in Rho are 1.07%, 1.00% (7%), and 1.00% (7%).
2. The values of reinforcement ratio for the case with wind loading has been changed significantly when the strength is changed from 28 MPa to 56 MPa, and to 84MPa. For the first floor column the Rho value has reduced from 4.46% to 1.34% (70%) to 1.0 % (78%) (Minimum specified by the ACI code) for the same first floor column, corresponding to the said strength values. However for the eighth floor the corresponding values in Rho are 4.9%, 4.76% (3%), and 2.51% (49%).

TABLE 1. Values of Rho (without wind load)

Rho Without Wind load		Fc=28 MPa		Fc=56 MPa		Fc=84 MPa	
		Fy=420 MPa		Fy=420 MPa		Fy=420 MPa	
		As Mm <sup>2</sup>	$\rho$ %	As Mm <sup>2</sup>	$\rho$ %	As Mm <sup>2</sup>	$\rho$ %
First Floor	Beam No.509	597	0.46	400	0.31	400	0.31
	Column No.106	1432	4.28	4423	1.25	2500	1.00
Fourth Floor	Beam No.273	1000	0.77	1000	0.77	900	0.69
	Column No.126	1398	1.10	6212	1.02	1448	1.00
Eighth Floor	Beam No.534	1100	0.88	950	0.80	910	0.70
	Column No.69	1690	1.07	1512	1.00	1350	1.00



TABLE 2. Percentage change in Rho (without wind load)

% Change in Rho Without Wind load		% Change 28 to 56	% Change 28 to 84
		$\rho$	$\rho$
First Floor	Beam No.509	-33	-33
	Column No.106	-71	-77
Fourth Floor	Beam No.521	0	-10
	Column No.273	-7	-20
Eighth Floor	Beam No.534	-9	-19
	Column No.69	-7	-7

TABLE 3. Values of Rho (with wind load)

Rho With Wind load		Fc=28 MPa		Fc=56 MPa		Fc=84 MPa	
		Fy=420 MPa		Fy=420 MPa		Fy=420 MPa	
		As Mm <sup>2</sup>	$\rho$ %	As Mm <sup>2</sup>	$\rho$ %	As Mm <sup>2</sup>	$\rho$ %
First Floor	Beam No.509	796	0.61	600	0.46	600	0.46
	Column No.106	1587	4.46	4608	1.34	2500	1
Fourth Floor	Beam No.273	1500	1.15	1500	1.15	1200	0.92
	Column No.126	7724	4.90	6428	3.17	1600	1
Eighth Floor	Beam No.534	1200	0.92	1000	0.81	900	0.69
	Column No.69	6864	4.90	8120	4.76	3952	2.51

TABLE 4. Percentage change in Rho (with wind load)

% Change in Rho With Wind load		% Change 28 to 56	% Change 28 to 84
		$\rho$	$\rho$
First Floor	Beam No.509	-25	-25
	Column No.106	-70	-78
Fourth Floor	Beam No.521	0	-20
	Column No.273	-35	-80
Eighth Floor	Beam No.534	-12	-25
	Column No.69	-3	-49

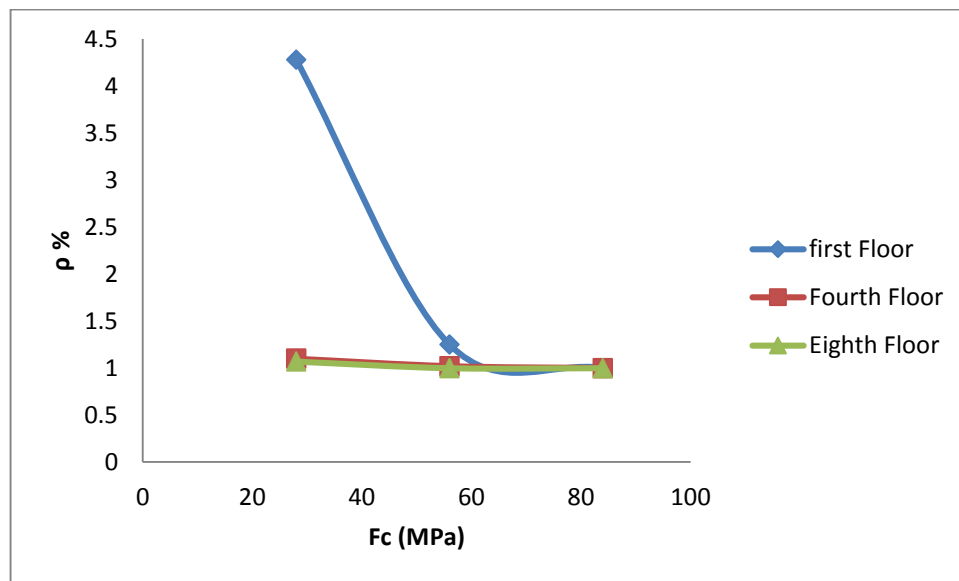

FIGURE 2. Column reinforcement ratio with compressive strength/ without wind load

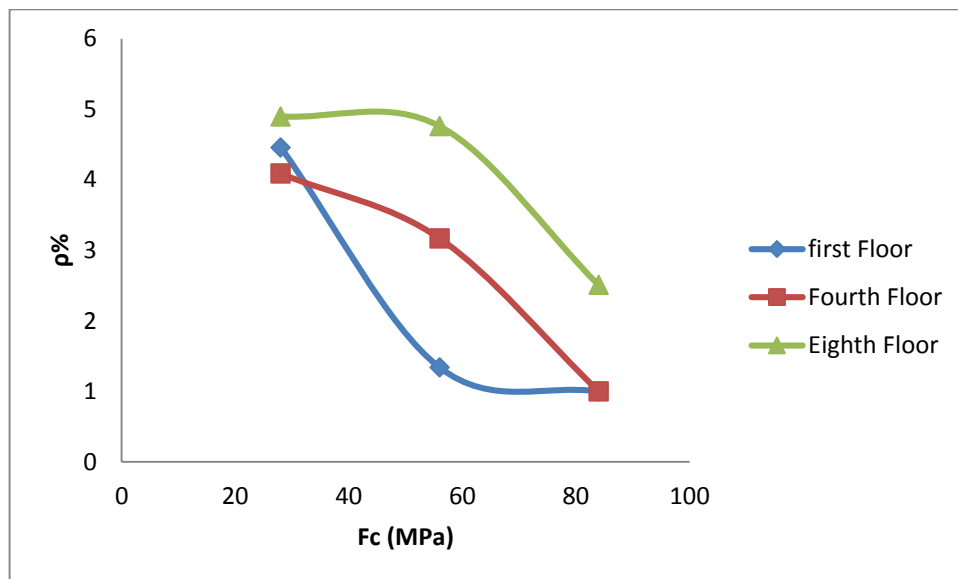

FIGURE 3. Column reinforcement ratio with compressive strength / wind load

## 6. CONCLUSIONS

Theoretical study on the effect of using concrete with different strengths for columns ranging from 28 MPa to 56 MPa, and to 84 MPa is presented in this work. Eight-story frame was analyzed as a case study representing a multi-story building in Erbil.

The following conclusions can be stated:

1. In high-rise buildings, the use of high strength concrete in column's construction is essential for resisting the high stresses resulted from heavy loading and lateral forces.
  - a. It is found in this project that the use of high strength concrete in columns may reduce the column size and increase the column capacity.
2. StaadPro 2007 v8i was used in this project to analyze the case study and it was found very suitable in applying the studied factors, especially the variation of concrete compressive strength of columns.
3. Maximum column moment change was found 7.69% when strength is changed from 28Mpa to 84 MPa. When wind loading is introduced the percentage change in column moments was maximum 8.8% percent. It can be seen that the analysis resulted in moderate change in maximum moment as expected.
4. Maximum column shear force change was found 6.35% when strength is changed from 28Mpa to 84 MPa. When wind loading is introduced the percentage change in shear force was maximum 8.12% percent. It can be seen that the analysis resulted in moderate change in maximum shear force as expected.
5. Maximum column axial force change was found 2.32% when strength is changed from 28 MPa to 84 MPa. When wind loading is introduced the

percentage change in axial force was maximum 5.99% percent. It can be seen that the analysis resulted in moderate change in maximum axial force as expected.

6. As described earlier the maximum changes in moments, shear and axial forces were detected at regions closer to the ground floor columns investigated with the change in the values of concrete strength. The percentage change was reduced as we move away from these regions.
7. The values of reinforcement ratio for the case without wind loading has been changed significantly when the strength is changed from 28MPa to 56MPa to 84MPa. For the first floor column the Rho value has reduced respectively from 4.28% to 1.25% (71%) to 1.0% (77%) for the first floor column no. 106. However for the eighth floor the corresponding values in Rho are 1.07%, 1.00% (7%), and 1.00% (7%).
8. The percent change in Rho for the case with wind load was 70% when strength is changed from 28 MPa to 56 MPa for first floor column no. 106 and was 78% when the strength changed from 28 MPa to 84 MPa. For the eighth floor column no. 69 the corresponding changes were 3.0% and 49%.
9. It can be concluded that the higher compressive strength for ground floor columns, the more saving will be obtained in the amount of reinforcement. In some cases the saving is up to 50%.

## REFERENCES

- [1] Reinforced Concrete, Mechanics and Design (6th Edition) by James K. Wight
- [2] Siao, W.B., "Reinforced Concrete Column Strength at Beam/Slab and Column Intersection" Journal of ACI Str., Vol. 91 No.1, pp 3-9, (1994).
- [3] ACI Committee 363, "363R -10 Report on High Strength Concrete," ACI 363 R-10", American Concrete Institute, Detroit 2010, 70pp.
- [4] ACI Committee 318, "Building Code Requirements for Reinforced Concrete, ACI 318-14", American Concrete Institute, Detroit 2014.
- [5] A.H. Nilson et al, "Design of Concrete Structures", McGraw Hill Book Company , 14th Edition, 2012.
- [6] Building Designers Manual, First Edition, Baghdad Central Library No. 1135, 1985.

## **Erbil Citadel Landscape Assessment In Order To Regional Best Practices**

Siba Nazem Kady<sup>1</sup>, Mahmood Hussein<sup>2</sup>

<sup>1&2</sup>*Department of Architecture and Interior Design, Ishik University, Erbil, KRG-Iraq*

<sup>1</sup>*Siba.kady@ishik.edu.iq*

<sup>2</sup>*mahmood.hussein@ishik.edu.iq*

### **ABSTRACT**

Many heritage areas around the world are suffered from neglect in maintenance or rehabilitation, and never consider their historical values as an attraction places for visitors, in addition to these problems a lot of ancient buildings were removed in different old cities and a new modern constructions were shown instead of traditional ones, and that leads to visual and structural distortion and thus a problem in tourism. The area surrounding the citadel of Erbil suffered from many of these troubles, thus we have to focus on them, and present suggestions to solve the problems by presenting a world successful experience in this field.

**Keywords:** Landscape, Erbil Citadel, Rehabilitation.

### **1. INTRODUCTION**

Many heritage areas around the world are suffered from lake in maintenance or rehabilitation, and never consider their historical values as an attraction places for visitors, in addition to these problems a lot of ancient buildings were removed in different old cities and new modern constructions were shown instead of traditional ones, and that leads to visual and structural distortion and thus a problem in tourism. The central area in Erbil is a traditional place, but it suffered from many problems in rehabilitation of the area around the citadel. Erbil Citadel and its landscape are very similar to Aleppo's citadel landscape which considered as a successful experience in restoration and rehabilitation, therefore we can present Aleppo central area as a typical regional experience, and focus on the problems of the Erbil's Citadel Landscape to get some criteria and recommendations can help us to suggest solutions could be carried out in the near future.

### **2. THE IMPORTANCE OF THE AREA SURROUNDING ALEPPO'S CITADEL**

The Citadel is the most important and distinguished land mark in the city of Aleppo. Its architectural and historical values are of local, regional, national, and international importance. By its location in the center of the lively historic district, the area surrounding the citadel is considered as the most promising for future tourism development in the city of Aleppo. [1]

Based on this value, several physical improvements have been carried out in the area such as the renewal of the landscape characteristics, rehabilitation of the old monuments and buildings around the citadel, traffic planning, and lighting.

### **3. ALEPPO'S CITADEL LANDSCAPE AND ITS CHARACTERISTICS**

The historical perspective in old cities is very important because it increases our understanding of the dynamic nature of landscapes and provides a frame of reference for assessing modern patterns and processors. [2]

So it is very important to focus on the landscaping around Aleppo Citadel and its surrounding by studying the following points: The slope and stone cladding- The moat- The entrance and Mamluk bridge tower- Street furniture. Figure (2)

#### **3.1 THE SLOPE AND STONE CLADDING**

The Citadel sits on the summit of natural mound, 40 meters above the city. This striking hill is formed partly from natural rock and partly from the layered ruins of various cultures, big areas of this slopes were covered with large lime stone slabs in Ayyubid Sultan [3]. Today only parts of the cladding remain because of the nature forces, so the rehabilitation here was to green of the resulted slope and covered some parts of it with panels of stones similar to the old ones. Figure (1) (2)

#### **3.2 THE MOAT**

The dry ditch surrounds the citadel with the depth of 22m and 30m in width, this moat in past was filled with water to prevent the penetration of the castle fortification [3]. The future suggestion here was to fill this moat with water again and use the lands around it as places for activities and relaxing. Figure (3)

#### **3.3 THE ENTRANCE AND MAMLUK BRIDGE TOWER**

The citadel's importance peaked during the period of Ayyubid rule- who they built the outer entrance of citadel - and also Mamluk rule who built the inner entrance and the main tower near the gate figure(4). These constructions restored and became ready for visitors. Figure (1)

#### **3.4 STREET FURNITURE**

The Street furniture is collective term for objects and pieces of equipment installed on streets and roads for various purposes, it included benches, light poles, canopies, trees, traffic barriers, bollards, traffic signs, street name sign, waste container, tiles, fences..... [4], but this furniture should be presented in traditional designs and materials not in modern ones, because it affects the appearance of the surrounding area. Figure (4)



FIGURE 1. Slope and Stone Cladding  
Ref.: Internet



FIGURE 2. Aleppo's Citadel  
and the moat  
Ref.: Internet



FIGURE 3. the Moat  
Ref.: Internet



FIGURE 4. Street Furniture  
Ref.: Internet

### **3.5 REHABILITATION OF THE OLD MONUMENTS AND BUILDINGS AROUND THE CITADEL**

Historical buildings have an important value to visitors as a part of their remembrance of historic times, and also as an example of cultural heritage. In general these heritage buildings divided into three main sections: public buildings, residential buildings and ancient market and old khans.

#### **3.5.1 PUBLIC BUILDINGS**

These monuments around the Aleppo Citadel such as religion places, hospitals and old public buildings became as tourist attraction areas, for that sometimes we can change the function of these buildings into tourist service places such as hotels, restaurants, cafeterias, and exhibitions....these activities enable visitors to enjoy the history of this city[5]. Figure (5)

#### **3.5.2 RESIDENTIAL BUILDINGS**

There are a lot of traditional houses around the citadel that complete the image of the old city and the landscape of the majestic castle, these buildings are renewing with local traditional materials, and the government encourages the population to restore their houses by giving them long-term loans to renew them according to the suggestion plans[3]. Figure (6)

### 3.5.3 THE ANCIENT MARKET AND OLD KHANS

The commercial buildings with their activities attract people to visit the old city and interest in shopping and walking around the citadel, so they took care about the doors, canopies, bulbs... fixing problems and unified them in traditional design [6]. Figure (7)



FIGURE 5. Example of a Public Building  
Ref.: Internet



FIGURE 6. Residential Buildings  
Ref.: Internet



FIGURE 7. the Ancient Market  
Ref.: Internet

### 3.6 TRAFFIC PLAN

The traffic plan in old cities is very important to support visitors and encourage tourists to enjoy the beautiful ancient citadel and the monuments around it in a safe way [7], so they considered these following main points which help to reach the goals

#### 3.6.1 CREATION PEDESTRIAN ZONES

The area around the citadel was equipped to become car-free but just for visitors and their activities, therefore the ground is paved with traditional stones that decrease the speed of vehicles, in addition many places are specified for squares, art, cultural and social activities such as exhibitions, cafeterias, concerts.....etc [7]. Figure (8)

#### 3.6.2 PARKING

Cars parking were considered as a very important part in the whole traffic planning, thus many outside lands and underground parking were providing in the landscape of the citadel.

#### 3.6.3 LIGHTING

The historical buildings and monuments could be an amazing architecture and engineering feats at night, fore that Development in lamp technology, providing more efficient artificial light sources and lighting the beautiful details of the structure could bring life and safety to these areas at night time [8][9]. Figure (9)



FIGURE 8. Creation Pedestrian Zones  
Ref.: Internet



FIGURE 9. Lighting at Night  
Ref.: Internet



#### **4. STUDY CENTRAL AREA IN ERBIL PROJECT**

Erbil Castle shape came from basic oval nucleus that has grown around the city of Erbil, because of the castle area of about 60,000 m<sup>2</sup>, And a height of about 35m has been a year, the city has grown around the castle in the form of start-rings from the castle and penetrate radial streets Constitute the axis leading to the city center and from the suburbs and to neighboring cities. Patten characterized castle type uses the ground Represented by the role of government and residential buildings that were used circles and official institutions, which appeared later at the bottom of the castle Made up the fabric of the new city of Erbil after it was these buildings occupies space located at the entrance of the castle and the President of the door Southern them, and these buildings can be seen as the civic center of the castle was almost complete Erbil citadel city where markets and collector School prayer and a school named after the castle has been the official residence of the castle of the city, and we have to mention that the land uses that Began to be the current city of Erbil over the years, but what are the main uses of the same, which consisted of buildings, including the castle (City (Old Erbil)) [10]

##### **4.1 DESIGN STRATEGY**

In March 2007 the House Consultative Engineering Office at the request of the Ministry of the municipality in the local government of the region of Kurdistan put the design basis report to the center of the city of Arbil [11], and in spite of the many aspects of the report, which confirmed the preservation of the historical value of the city and its identity, but executing the design stages of the analysis show follows:

- Change the parts surrounding the castle of the traditional architectural style to talk through the conversion of the northern part (who fulfill the residential area) to cultural entertainment center includes a number of cultural buildings, such as the arts center and opera house in addition to the public library with architectural contemporary characters, and build my shopping complex modern and very huge called market (Neshteman) to the south which is a very huge market in terms of space as an area as far as the area of building almost to the castle and the height of six floors above ground this except floors located underground a basement which does not carry any heritage character has to do with the castle is not in terms of materials and details.
- Destruction of the surrounding areas and the demolition of the castle Traditional shops which adjoins the castle of your hand for visitors to climb the slope and the transfer to the new owners of the shops and the market continue to dump the lands around the castle and the conversion process. (Shop owners to the new market in which to work.
- Building public transport station of the population in the basement of the crypt inside the market and find a new movement knot roads linking the bottom of the market and the new node converted to the movement of public transport.
- Conversion of open areas to sit outside for visitors and tourists areas.

## 4.2 REHABILITATION OF THE OLD MONUMENTS AND BUILDINGS AROUND THE CITADEL

As we documented in 2014 after 7 years of implementing project and with compared with Aleppo citadel surroundings area according to research topics is listed below:

### 4.2.1 PUBLIC BUILDINGS

There is an standing project convert to ( Citadel Hotel ) (Qalat Hotel) and it seems not big enough to have more than 30 visitors & it have 4 Stars m the character of this hotel is traditional & it's still have the same elevations as it was, but it is not suitable to much visitors, the area surrounded to citadel have many Hotels.

### 4.2.2 RESIDENTIAL BUILDINGS

All buildings around the citadel, the Kurdistan Regional Government, KRG start to change their elevations to have the same traditional faces, all buildings have the same tradition material (Brick) but also need to force the Shops owners to have the same Doors, some of them are metal, some of them are glass...etc



FIGURE 10. Qalat Hotel  
Ref: Researcher photos



FIGURE 11. Hotels around Qalat  
Ref: Researcher photos

### 4.2.3 THE ANCIENT MARKET

The commercial buildings with their activities attract people to visit the old city and interest in Shopping and walking around the citadel, so we have to take care of the doors, canopies, bulbs...fixing problems and unified them in traditional design.



FIGURE 12. the Ancient Market  
Ref: Researcher photos



FIGURE 13. Pedestrian Zone  
Ref: Researcher photos

### 4.3 TRAFFIC PLAN

As we noticed there is no planning for traffic, there is mixed in traffic between cars and pedestrian and there is no distribution between them and this is not safe for both.

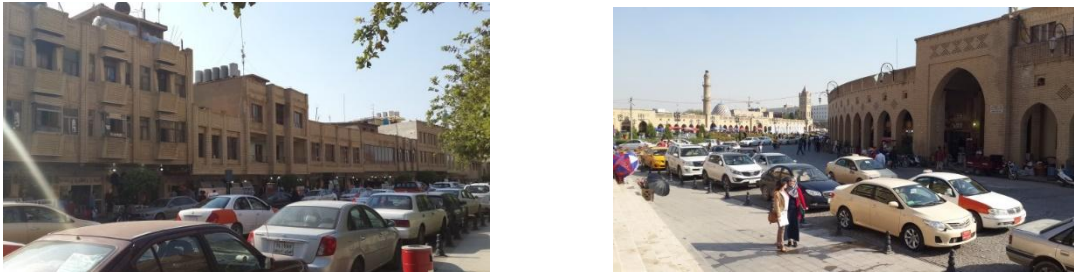

FIGURE 14. Traffic near Citadel  
Ref.: Researcher photos

#### 4.3.1 CREATION PEDESTRIAN ZONES

There are 2 places for pedestrian's creations zone one of them is fully with water fountains and it is crowded all the time, the other one most of the time is empty cause it is far away from local market.



FIGURE 15. Creation & Pedestrian Zone near Citadel  
Ref.: Researcher photos

#### 4.3.2 PARKING

There is lack of parking in this area, the Neshteman mall have a market but it is too far from the center area, also the cars used the side of streets for parking in 2 or 3 lanes this effect on traffic.

### 4.4 LIGHTING

There is no professional lighting in this area it is some of economic lighting without sense of art.



FIGURE 16. Night lighting  
Ref.: Researcher photos

## 5. RESULTS AND RECOMMENDATION

- Leaders and Planners have to provide laws and legislation to prevent using modern materials instead of traditional ones in buildings elevations around the citadel.
- Increasing the awareness of the importance of citadel landscape as one of the effective ways to increase the tourism in the city.
- It is possible to propose an environment-friendly and aesthetic solution for the citadel landscape by greening the slope of the citadel to increase the green area around it and give the surrounding a beautiful view.
- In order to have a long lasting tourism improvement in Erbil and around the citadel, pedestrian zones with various activities, street furniture and parking (outside and underground) should be considered in every future planning.
- Further studies should consider various lighting technology to support and provide more efficient artificial light sources to bring life and safety to the citadel zone.
- Planners and designers should take procedures to attract tourists by changing the function of some traditional distinct buildings into entertainment places such as hotels, restaurants, cafes.

## REFERENCES

- [1] [www.akdn.org/hcp/syria.asp](http://www.akdn.org/hcp/syria.asp) accessed date 1/2/2016
- [2] Holland Marjorie, Risser Paul, Naiman Robert, 1991- The Role of Landscape Boundaries in the Management and Restoration of Changing Environments, 1st ed, Chapman&Hall, Inc, New York
- [3] Agh Khan Trust for Culture, 2008- The Citadel of Aleppo, PDF
- [4] Stefano Bianca., Jean Claude David, 1980- The Conservation of the Old City of Aleppo, 1st ed, Paris, France.
- [5] Agh Khan Trust for Culture, 2008- Revitalizing The Citadels of Syria , PDF
- [6] Mike Jenks., Nicola Dempsey, 2005- Future Form and Design for sustainable cities, 1st ed, Elsevier, oxford, united states.
- [7] Directorate of the rehabilitation of the old city of Aleppo
- [8] Derek Philips, 2004- Day Lighting. 1st ed, Elsevier, Paris, France.
- [9] Derek Philips, 2004- Lighting Historic Building, 1st ed, McGraw-Hill.

## Experimental Investigation on Pressure Coefficients along Bottom Surface of Dam Tunnel Gate With aid of Mapping Presentations

Assoc.prof.Dr.Thamir M. Ahmed

*Department of Civil Engineering, Ishik University, Erbil,KRG-Iraq  
thamir.ahmed@ishik.edu.iq*

### ABSTRACT

Vertical lift gate is almost installed within the dam tunnel to control the water heads and quantity .The major function of such gate are to satisfy the requirements of power generation and demand of water downstream the dam. The bottom gate surface exposed to high pressure induced by water jet issuing below the gate and uplift force is produced and effect the operation and stability of the gate. In present research the physical hydraulic model was used to study the behavior of water flow pattern below the gate and the generation of pressure for two different lip gate geometries .The measurements upstream head ,downstream head ,jet velocity and peizometric heads distribution along and across the bottom gate surface were involved .The results were analyzed and expressed by using three dimensions presentation .The main conclusion states that the bottom pressure coefficient is influenced clearly by the lip gate shapes and gate openings .

**Keywords:** pressure coefficient ,hydraulic force ,tunnel dam gate.

### 1. INTRODUCTION

The hydrodynamic forces on vertical gates are commonly exerted by high heads water of dam reservoir and impacted the upstream face, top and bottom surfaces of the gate .The operation and safety of the gates are directly affected by these forces and hence the prediction of such forces have been received much more attention from researchers and designers.

The parameters affected the bottom pressure coefficient on high head gate has been studied by the Reclamation Hydraulic Laboratory Colgate Donald (1959), the pressure area computation method was used to estimate the pressure head distributions and it was found that the not all parameters can be presented through a mathematical analysis with a certain extend.

The main parameters affected the bottom pressure coefficient are summarized by Sagar (1977) which can be expressed by the following form:

$$K_b = f \left( \frac{x}{x_o}, H_i, H_d, \frac{v_j^2}{2g}, \frac{y}{y_o} \right) \quad (1)$$

Where

$K_b$ : Bottom pressure coefficient,

$\frac{x}{x_0}$ : Distance ratio along bottom gate Surface,  
 $\frac{Y}{Y_0}$ : Opening ratio,  
 $H_i$ : Peizometric head on bottom gate surface,  
 $\frac{V_j^2}{2g}$ : Jet velocity head, and  
 $H_d$ : Downstream peizometric head.

The flow conditions and gate geometry were studied by Naudascher et al (1964) to evaluate the bottom pressure coefficient .It is found that the bottom pressure coefficient can determined as follows:

$$K_b = \left(\frac{1}{B \cdot d}\right) \iint [(H_i - Y_s) / \left(\frac{V_j^2}{2g}\right)] dB \cdot dx \quad (2)$$

Where:

$Y_s$ : Pressure head in the section of contracted jet,  
 $B$ : Gate width, and  
 $d$ : Gate thickness.

The design of the 3-leaf intake gate as a result of experimental study simulating the TVAS Melton Hill Dam was presented by Elder, R. A. and Garrison (1964). The experiments involved the examination of five proposed gate lip shapes and nine other basic shapes. Some difficulties were encountered due to the large hydraulic forces induced by lip forms, oscillation and prevention of the leaves to close.

The effects of different flow conditions on the bottom surface local pressure of intake gate was studied by Thang (1983) . The study indicates that the values of downpull and discharge coefficients are sensitive due to the flow separation from the gate bottom surface.

The behavior of flow pattern and its effects on pressure fluctuations along the bottom gate surface were investigated by Bhargava (1989).The study include the measurements of many hydraulic parameters with respect to different gate openings. The study reveals that the values of hydraulic force is influenced by the pressure fluctuation and consequent vibration.

Thang (1990); studied the effects different geometrics of bottom gates and discharge conditions on dynamic loads applied by water flow on vertical-lift gates with in an open channel and at a conduit inlet. The study was included the observation of vibrations which it may happened according flow fluctuated between complete attachment and re-attachment at the gate bottom. It was concluded that the slope of the average lift curve acting on the gate bottom will contribute the determination of critical range of gate openings with respect to potential gate vibration.

A one dimensional analyses were used by Al-Kadi (1997); to predict the effects of many hydraulic parameters on downpull forces acting on the bottom of vertical lift gate The analysis were based upon the methodology of finite element program by considered two models,one with constant eddy viscosity, and the other of variable

eddy viscosity which is important or estimating the upward downpull for large gate openings. The model was verified with actual records and gave good results.

The effects of many gate geometries with different gap width ratios on downpull force are examined by Ahmed (1999) was used the hydraulic model to measure all required parameters to estimate the downpull .It is found that the downpull force is influenced manly by gate geometries, gate openings and gap ratios of gate shaft .

## 2. EXPERIMENTAL WORK

The bottom pressure coefficient ( $K_b$ ) is affected by numerous parameters which are mentioned earlier by equation (1).The estimation of ( $K_b$ ) is required principally the measurements of pressure heads along the bottom gate surface , pressure heads downstream the gate shaft and velocity in contracted section below the gate. In present study, the model gate made by a thick plate with a thickness of 5 mm was connected by steel rode to permit its vertical movements through gate shaft which has been installed in the middle of tunnel (4m long, 0.2 m width and 0.3 m Height).The openings of gate and it can be adjustable by a screw placed on the top of the shaft. The gate was provided with two sets of taps located along the lip parallel to the direction of flow, first set with five taps fixed at a distance 0.25 B from right gate edge with equal interval distance from each to other, the second set located at 0.5 B with five taps of equal interval distance. These taps have been connected to the manometer board through plastic tubes to measure the peizometric heads along and across the bottom gate surface ( $H_i$ ).

## 3. RESULTS AND DISCUSSIONS

In present research, the results of ( $K_b$ ) values are based upon the experimental measurements and represented by using three dimensional model software. Two inclined lip gate shape with ( $\theta=35^\circ$ ) were examined. The principles of pressure fluctuations according to the values of ( $k_b$ ) along the bottom gate surface were used to indicate the effects of flow pattern on hydraulic forces and vibration impact on lift gate surface. However, the bottom pressure coefficient ( $K_b$ ) is calculated using the following expression:

$$K_b = \frac{(H_i - H_d)}{\frac{v_j^2}{2g}} \quad (3)$$

It can be seen from figure (1) that for ( $Y/Y_o=10\%$ ) and ( $X/d$ ) from leading edge up to 40%, the ( $K_b$ ) values are varied uniformly and some changes in distribution occurred when the increased values have been located on both sides of bottom gate surface and the maximum value of ( $K_b$ ) observed on middle of last third of gate. Hence, the flow behavior is seemed to be with attachment mode along the gate surface which may cause less probability for problem due to vibrations.

Figure (2) indicates that in general, the values of ( $K_b$ ) for ( $Y/Y_o=20\%$ ) becomes less and increased from leading edge ( $X/d=20\%$ ) with small interval difference toward the maximum value of ( $K_b$ ) which has also been appeared near the last third of gate surface. The low values of ( $K_b$ ) revealed a poor attachment of flow stream lines with gate surface.



The values of  $(K_b)$  for  $(Y/Y_o=30\%)$  are uniformly increased from leading edge up to  $(X/d=35\%)$  as shown in figure (3) and then decreased from the middle part toward the both sides of gate surface up to  $(X/d=70\%)$ . It can also be observed, that around  $(X/d=80\%)$ , the values of  $(K_b)$  are increased across the gate surface and reach the maximum value just near the side edges. Thereafter, the  $(K_b)$  values are decreased beyond  $(X/d=85\%)$  up to trailing edge of gate surface. Such fluctuations in the values of  $(K_b)$  assured that the phenomenon of attachment and reattachment of stream lines flow have been established and the problems of vibration will be more probable occurred.

Figure (4) is indicated the for  $(Y/Y_o=40\%)$ , the values of  $(K_b)$  are relatively becomes less. The figure shows that the high values of  $(K_b)$  are collected with the region of  $(X/d=45\%$  and  $X/d=90\%$ ) and the maximum values concentrated at  $(X/d=80\%)$  near the side edges. The significant reattachment can be observed within the middle part and especially on both side edges of  $(X/d=80\%)$ .

Figure (5) is indicates that for  $(Y/Y_o=60\%)$ , the values of  $(K_b)$  are increased throughout the bottom gate surface with a little bit changes in interval differences. Hereby, the high values of  $(K_b)$  can be seen between  $(X/d=75\%$  and  $X/d=90\%)$  whereas, the maximum values of  $(K_b)$  can be observed in two positions near the side edges, at  $(X/d=40\%)$  and  $(X/d=80\%)$  which reflects the strong attachment impact.

It can be seen from figure (6), that for  $(Y/Y_o=70\%)$ , the low values of  $(K_b)$  are observed at the beginning part of gate from leading edge up to  $(X/d=20\%)$  and last part beyond  $(X/d=90\%)$ . The more uniform high values of  $(K_b)$  are located mostly on part of bottom surface between  $(X/d=30\%$  and  $X/d=80\%)$ . The maximum values of  $(K_b)$  are observed on both side edges of the same mentioned region.

For  $(Y/Y_o=80\%)$ , the uniform distribution of increased  $(K_b)$  values can be seen in figure (7). The flow attachment is started from the leading edge up to trailing edge and the maximum values are indicated between  $(X/d=85\%)$  and  $(X/d=100\%)$ . In such case, the uniform increase of  $(K_b)$  values along the bottom surface of gate will reduce the probability of variation problems.

#### 4. CONCLUSIONS

For  $(Y/Y_o=10\%)$  and  $(X/d)$  from leading edge up to 40%, the  $(K_b)$  values are varied uniformly and some changes in distribution occurred when the increased values have been located on both sides. The maximum value of  $(K_b)$  observed on middle of last third of gate.

The attachment mode along the gate surface which may cause less probability for problem due to vibrations.

The values of  $(K_b)$  for  $(Y/Y_o=20\%)$  becomes less and increased from leading edge  $(X/d=20\%)$  with small interval.

For  $(Y/Y_o=30\%)$ , the values of  $(K_b)$  are increased across the gate surface and reach the maximum value just near the side edges. The fluctuations in the values of  $(K_b)$  assured that the phenomenon of attachment and reattachment of stream lines



flow have been established and the problems of vibration will be more probable occurred.

For ( $Y/Y_o=40\%$ ), the values of ( $K_b$ ) are relatively become less.

For ( $Y/Y_o=60\%$ ), the values of ( $K_b$ ) are increased throughout the bottom gate surface with a little bit changes, the maximum values of ( $K_b$ ) can be observed in two positions near the side edges ,at ( $X/d=40\%$ ) and ( $X/d=80\%$ ) which reflects the strong attachment impact.

For ( $Y/Y_o=70\%$ ), the low values of ( $K_b$ ) are observed at the beginning part of gate from leading edge up to ( $X/d=20\%$ ) and last part beyond ( $X/d=90\%$ ).

For ( $Y/Y_o=80\%$ ), , the uniform increase of ( $K_b$ ) values along the bottom surface of gate will reduce the probability of variation problems.

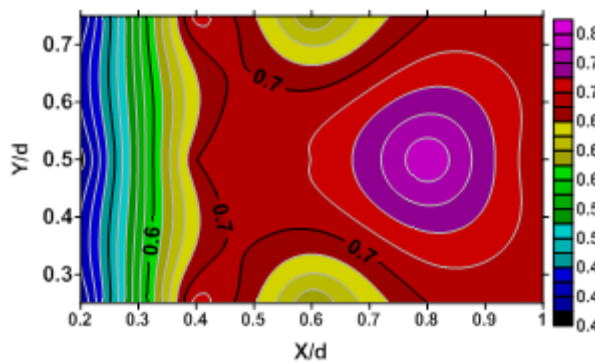

FIGURE 1.Variation of ( $K_b$ ) for ( $Y/Y_o=10\%$ )

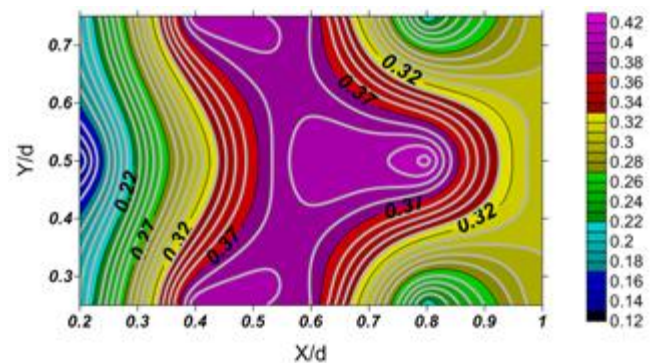

FIGURE 2.Variation of ( $K_b$ ) for ( $Y/Y_o=20\%$ )

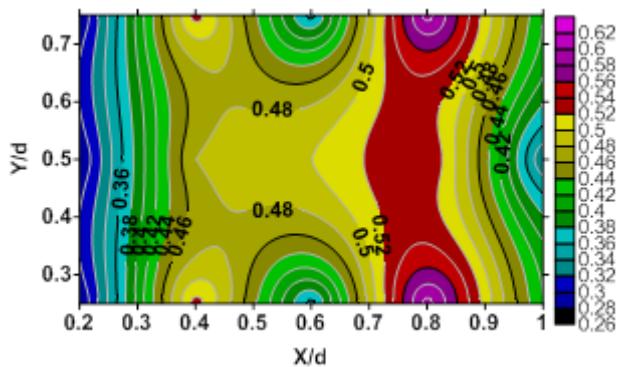

FIGURE 3.Variation of ( $K_b$ ) for ( $Y/Y_o=30\%$ )

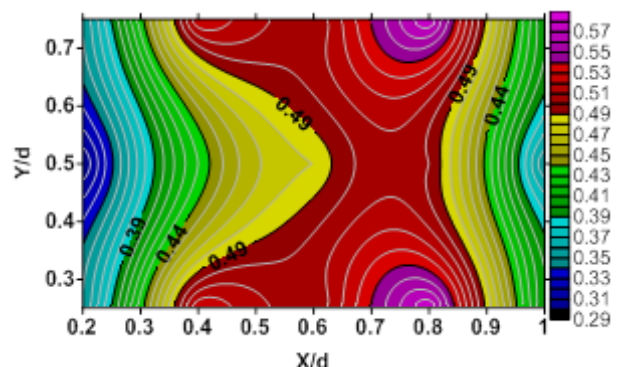

FIGURE 4.Variation of ( $K_b$ ) for ( $Y/Y_o=40\%$ )

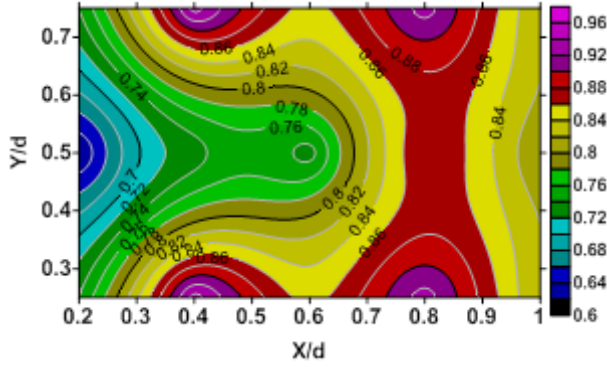

FIGURE 5. Variation of ( $K_b$ )

for ( $Y/Y_o=60\%$ )

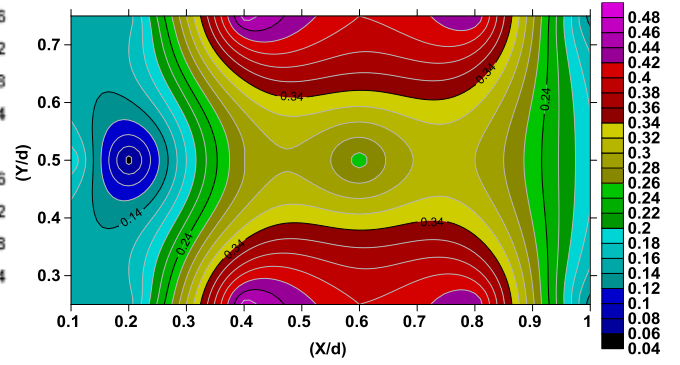

FIGURE 6. Variation of ( $K_b$ )

for ( $Y/Y_o=70\%$ )

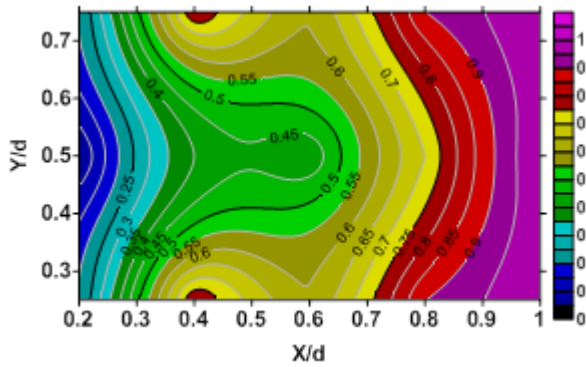

FIGURE 7. Variation of ( $K_b$ ) for ( $Y/Y_o=80\%$ )

## REFERENCES

- [1] Ahmed, T. M., "Effect of Gate Lip Shapes on the Downpull Force in Tunnel Gates", Ph. D Thesis Submitted to the College of Engineering, University of Baghdad, 1999.
- [2] Al-Kadi, B. T., "Numerical Evaluation of Downpull Force in Tunnel Gates", Ph. D Thesis Submitted to the College of Engineering, University of Baghdad, 1997.
- [3] Bhargava, V. P., and Narasimhan, S., "Pressure Fluctuations on Gates", Journal of Hydraulic Research, Vol. 27, No. 2, 1989.
- [4] Colgate Donald. "Hydraulic Down pull Forces on High Head Gates", ASCE HY 11, November, (1959).
- [5] Elder, R. A. and Garrison, J. M., "Flow Induced Hydraulic Forces on Three Leaf Intake Gates", ASCE, Vol. 90, No. 3, 1964.
- [6] Naudascher, E., Kobus, H. E. and Rao, R.R., "Hydrodynamic Analysis for High- Head Leaf Gates". ASCE, Journal of the Hydraulic Division. Vol. 90, No. 3, Pp. 155- 192, 1964.
- [7] Sagar, B. T. A., "Downpull in High Head Gate Installation", Water Power and Dam Construction, March, April and May 1977.
- [8] Thang, N. D. and Naudascher, E., "Approach Flow Effect on Downpull of Gates", ASCE, Vol. 109, No. 11, November .1983.
- [9] Thang, Nguyen D., "Gate vibration Due to Unstable Flow Separation " ASCE VOL. 116, No. HY3, March 1990.

## Can Image Processing Technique Be Used as a Non-destructive Test In Predicting Concrete Compressive Strength

Khalid B. Najim

*Civil Engineering Department, College of Engineering, University of Anbar-Iraq  
dr.khalid.najim@gmail.com*

### ABSTRACT

The use of non-destructive tests in evaluating concrete strength has received increasing attention during the last decades. Ultrasonic Pulse Velocity (UPV) and Rebound Number (RN) have been using in this regard. The aim of this study is to examine the use of image analysis technique represented by gray color value (GV) as a non-destructive test. 150 cubes were casted and non-destructively tested in terms of UPV, RN, and GV and destructively and the experimental results were correlated using regression analysis. Single variable regression models were used to predict concrete compressive strength. The statistical analysis and the experimental validation revealed that GV is not recommended to be used as a non-destructive.

**Keywords:** Concrete compressive strength, image processing technique, Gray value, Non-destructive tests, imageJ.

### 1. INTRODUCTION

Compressive strength  $f_{cu}$  is important, in reinforced concrete design, in determining both structural member dimensions and steel reinforcement ration ( $\rho$ ). Therefore, the test result ( $f_{cu}$  value) should satisfy the requirements of structural integrity. Namely, the average of the tested specimens' compressive strength should be equal or exceed the design compressive strength [1]. In some cases; however, the laboratory test reveals that the tested specimens do not provide the required strength i.e. < design compressive strength. In such case, the used concrete should be evaluated to conserve the structural integrity as the tested specimens, sometimes, do not represent the casted concrete for many reasons such as human mistakes in terms of both sampling and testing, poor curing, etc. Additionally, old and damaged structures need, sometimes, to be assessed for safety and constructional (repairing) reasons during their surface life which, again, compressive strength is the crucial factor.

Unlike the destructive tests like core and loading tests, Non-destructive Tests (NDTs) are considered economical and time-save tests which can be used to predict the concrete compressive strength. These tests are Ultrasonic Pulse Velocity (UPV), Schmidt Hammer Test (Rebound number (RN)), resonance frequency, pin penetration, pull-out, and radiative and magnetic [2-5]. Gregor *et al* [6] concluded that concrete compressive strength is usually determined using empirical relations or charts between compressive strength and NDT parameters. However, these relations could be not suitable for wide range of concrete classes as the concrete is not a homogenous material and its strength

is affected by many factors such as aggregate type and quantity, cement and water content, curing method and age, etc.

Image processing technique is characterized by a computer- based process including image provision, digitalization, segmentation, following by image enhancement, classification, recording and recalling. In concrete engineering, it has firstly been used in assessing physico-mechanical properties of concrete where, the nature of pore structure of concrete was observed by Lange et al [7] using images of back-scattered electrons with luminous sections. Whereas, the location of steel reinforcement into a concrete body was studied by Gaydecki et al [8] using a portative scanning system with an inductive sensor. Huon et al. [9] analysed the mechanical behavior of normal and high-strength concretes under semi-static loading employing infrared thermography and digital image correlation. Recently, Concrete compressive strength value was estimated with a "high correlation" based on aggregate and cement matrix percentage in the concrete mix using regression analysis. The aggregate, air-gaps, and cement percentages were calculated from processing the images of concrete sections using imageJ software [10]. More recently, the compressive strength of a modified mortar was predicted using a relation between the actual (measured) compressive strength and a non-destructive parameter called gray colour value (GV) obtained from analyzing a captured image of a mortar specimen using image processing technique [11]. The aim of this study is to examine the use of image processing technique indicated by GV as a non-destructive test to predict concrete compressive strength. Experimental validation for the proposed model will be also carried out.

## **2. EXPERIMENTAL PROGRAM**

Thirty different mixes (different proportions, w/c, and cement content) were designed to provide  $f_{cu}$  between 25-50 MPa. Ordinary Portland Cement (OPC) type I from same patch was used for all mixes in order to neglect the potential effect of cement color on the concrete GV. Mineral coarse aggregate with different maximum sizes of 12, 14, and 20mm in addition to natural sand with 4.75mm maximum size were used. 150 cubic samples of 150×150×150 mm (5 samples for each mix) were casted, water-cured for 28-days and then tested in terms of compressive strength UPV, RN and image analysis to obtain GV (as it would be later explained). UPV (direct) was measured using a commercially available Portable Ultrasonic Nondestructive Digital Indicator Tester as commercially known (PUNDIT) according to BS 1881-203[12]. Compressive strength test has been carried out based on BS 1881-116 [13] while RN was tested in accordance with BS 1881:202 [14]. The record UPV and RN were the average of four and thirty-six readings respectively where it was recommended that the number of minimum measurements should be at least 4 for UPV and 9 for RN [15].

## **3. IMAGE PROCESSING TECHNIQUE**

After 28 days water-curing of the tested concrete samples, which is the usual age, the cubic samples were placed inside an oven for an hour at about 50°C (after many trials) to make the photographed surface is totally dry. This was to remove moisture effect on

the gray color value as the moisture increases the darkness of concrete. The digital images of the tested specimens were photographed using a 14 mega pixel canon camera and same photographing system that used elsewhere [10] has been adopted, as seen in Fig1. The captured images were firstly imported to imageJ software by drag and drop and then rectangular icon tool was applied to crop the image using 'crop' edit feature that installed in 'image' icon tool in order to minimise edge effects. The cropped images have constant dimensions of 1500 ×1500 pixels, which mean that each image is composed of a matrix with 1500 rows and 1500 columns. It means that each image has constant count of 2,250,000 pixels.

The imported images were then converted from RGB colour feature to 8-bit greyscale (binary) followed by applying 'histograms' feature that installed in 'analyze icon' of imageJ software tool, which represents the graphical expressions of pixel values on the examined image. Histogram analysis has been carried out for each imported images in a grayscale image, hence, the number of pixels for each analysed point was obtained, which represents the (GV) that directly shown at the software page as seen in Fig 2. Grayscale values of a binary image consists of 256 different hue values i.e. ( $G = \{0, 1, 2, \dots, 255\}$ ), which means that (256 gray values), a byte (1 byte = 8 bit and  $2^8 = 256$ ). This means that 0 and 255 values correspond to black and white respectively and the gray tones spread in between these values [16]. The GV in this study is representing the average of sixty readings i.e. ten in each face of the concrete cubic specimen.

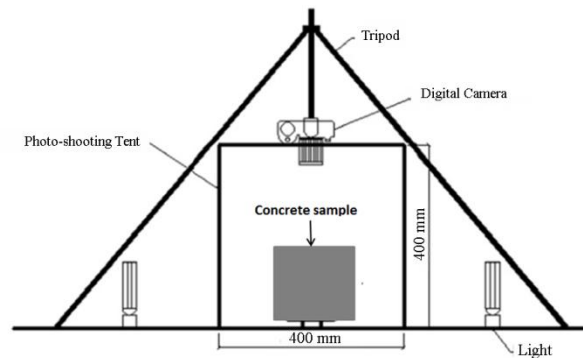

FIGURE 1. Set-up to photograph digital images [16]

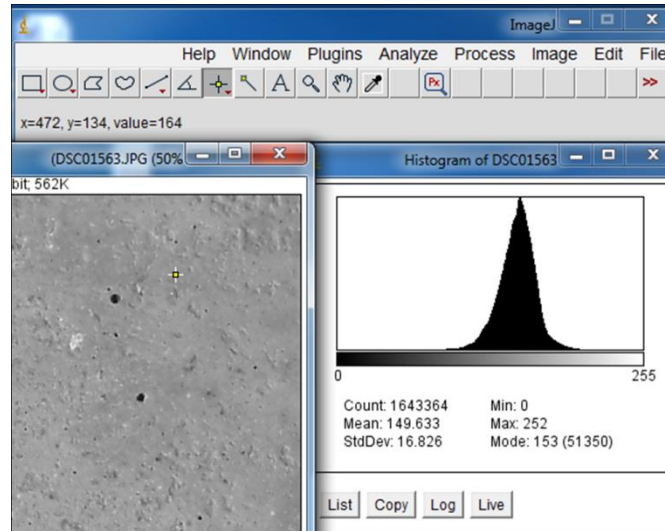

FIGURE 2. Gray color value (GV) calculation

#### 4. REGRESSION MODELS AND THEIR EXPERIMENTAL VALIDATION

It was well-documented that concrete compressive strength can be correlated with UPV and hence the first can be arguably predicted using numerous formulas. The mostly agreed formula is a single-variable exponential regression model, as seen in Eq. 1 [6].

$$f_{cu} = a * \exp(b * UPV) \quad (1)$$

Where a and b are empirical parameters determined by least square method. Although, there is no unique relationship between concrete compressive strength and rebound number, as a physical measurement of the concrete surface hardness, experimental relationships can be presented for a given concrete [17]. In order to examine the possibility of using image processing technique represented by GV as a non-destructive test in predicting concrete compressive strength, regression analysis has been carried out on the experimental results. Actual concrete compressive strength was correlated with UPV, RN, and GV using best fit-curve to build single-variable regression models to predict concrete compressive strength and these models are respectively presented in Eqs 2, 3, and 4. The relationships between the actual compressive strengths and the results of the used non-destructive tests i.e. UPV, RN, and GV were illustrated in Figs 3, 4, and 5 respectively.

$$f_{cu} = 7.3487 * e^{0.0004 * UPV} \quad (2)$$

$$f_{cu} = 1.3741 * RN^{1.0207} \quad (3)$$

$$f_{cu} = 10.482 * e^{0.0077 * GV} \quad (4)$$

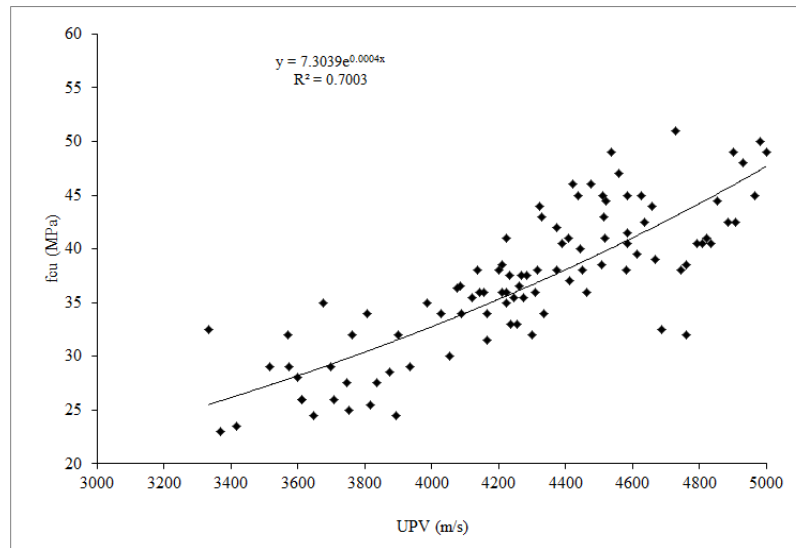

FIGURE 3. The relationship between  $UPV$  and actual  $f_{cu}$

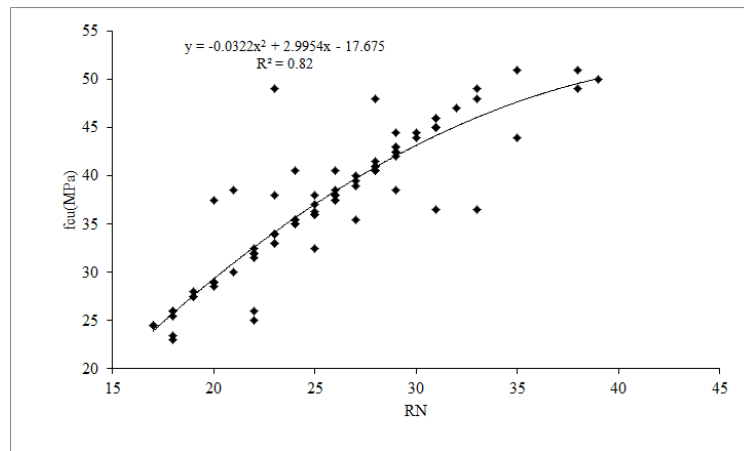

FIGURE 4. The relationship between  $RN$  and actual  $f_{cu}$

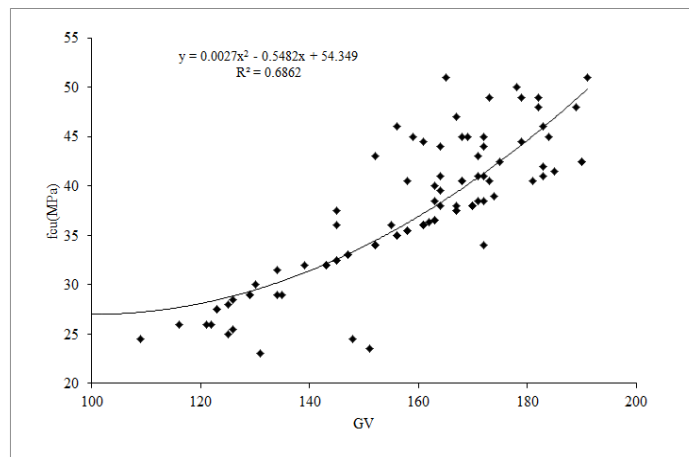

FIGURE 5. The relationship between  $GV$  and  $f_{cu}$



The relationship between the actual and determined/ predicted compressive strength by the proposed models was shown in Fig.6. Statistical analysis has been made for the results (compressive strengths) that obtained by the proposed regression models as presented in Table 1. UPV and RN as non-destructive tests have widely been used; GV model (Eq. 4) has statistically been compared with these models i.e. Eqs 2 and 3. It can be seen that the coefficient of correlation  $R^2$  was very low for GV model (Eq.4) in comparison with Eqs 2 and 3. Descriptive statistic tool that installed in Data Analysis feature in Microsoft Excel was used to determine the standard deviation (SD), standard error (SE), and sample variance (SV) for compressive strengths that calculated using the propose regression models. Table 1 shows that standard error (the average distance that the observed values fall from the regression line) values are less than 2 and for GV regression is less than 1(smaller values are better because it indicates that the observations are closer to the fitted line). It means that all regressions are statistically acceptable in this regard. Variance of Eq. 4 is far small than that for other models which indicates that the data points tend to be very close to the mean and hence to each other. Unlike for Eqs 2 and 3that indicates the data points are very spread out around the mean and from each other. Same trend can be observed for SD which is expected as it represents the square root of the variance. It seems that GV models that presented in Eq.4 is statistically representing the data better that others, as seen in Table 1;however, it cannot be reliably used in predicting concrete compressive strength as  $R^2$  value is very low.

To experimentally validate the suggested regression models (Eqs 2, 3, and 4) and also to compare GV model with the others, in terms of their accuracy, additional 15 specimens of 150 mm cube were prepared using same materials and under same condition. They were water-cured and tested at age of 28 days. They had different compressive strengths as shown in Table 2 and they were non-destructively tested i.e. UPV, RN, and GV as previously explained before destructively tasted (crush test) to obtain actual compressive strength. Table 2 shows that the predicted compressive strengths using Eq.4 have less accuracy in comparison with Eqs 2 and 3. Whilst the number of the predicted  $f_{cu}$  that having greater than 80% accuracy in comparison with corresponding actual value is only 6 (out of 15) for Eq.4, it was 15 and 12 for Eqs 2 and 3 respectively. This is an experimental confirmation of the previous conclusion that states GV not recommended to be used alone as a non-destructive test to evaluate concrete compressive strength.

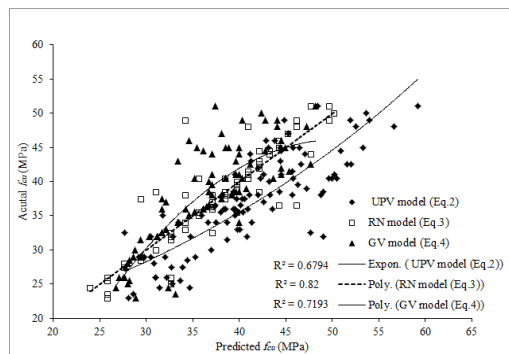

FIGURE 6. The relationship between actual and determined  $f_{cu}$

TABLE 1. Statistical analysis of the regression models

Regression models	Eq.2	Eq.3	Eq.4
Coefficient of correlation	0.842	0.803	0.204
Standard Deviation	6.58	7.53	3.69
Standard Error	1.700	1.943	0.950
Variance	43.35	56.66	13.59

TABLE 2. Results of experimental validation of all models

	NDTs results			Predicted compressive strength (MPa) based on			
	UPV	RN	CV	Actual $f_{cu}$	Eq.2	Eq.3	Eq.4
150 mm cubic samples results (Laboratory validation)	3920	25	138	35	35.3(99)*	36.7(95)	30.3(84)
	4950	33	168	56	53.2(95)	48.7(87)	38.2(53)
	5076	34	146	57	56.0(98)	50.3(88)	32.3(23)
	4178	23	161	33	39.1(82)	33.7(98)	36.2(91)
	3978	26	143	36	36.1(99)	38.2(94)	31.5(86)
	4717	27	171	40.5	48.5(80)	39.7(98)	39.1(96)
	4717	29	178	43.5	48.5(88)	42.7(98)	41.3(95)
	4808	27	183	46	50.3(91)	39.7(86)	42.9(93)
	4644	25	161	48.5	47.1(97)	36.7(75)	36.2(66)
	4824	30	166	50.5	50.6(99)	44.2(87)	37.6(65)
	4839	27	173	53	50.9(96)	39.7(75)	39.7(66)
	4886	30	173	56.5	51.9(91)	44.2(78)	39.7(58)
	4966	36	178	65	53.5(82)	53.3(82)	41.3(42)
	5019	39	164	64	54.7(85)	57.8(90)	37.1(28)
	4950	38	161	62	53.2(86)	56.3(90)	36.2(29)

— >90%

9 7 4

80%-90%	6	5	2
70%-80%	0	3	0
<70%	0	0	9

\*X(Y): X is the predicted  $f_{cu}$  (MPa), Y is (%) of accuracy in comparison with the actual  $f_{cu}$

## 5. CONCLUSION

A handful of previous studies have conducted to employ the image processing technique as a non-destructive test to evaluate concrete strength. Most of these studies required some details about the mix design in terms of used materials properties and their proportions which are not always available. Image processing technique can provide many parameters that can be used in predicting concrete compressive strength such as gray color value (GV) which has not yet been examined. In this study, regression analysis was used in correlating actual (tested) compressive strength with GV to propose single and triple (with UPV and RN) variable regression models to predict concrete compressive strength. The proposed models were statistically analyzed and experimentally validated in addition to compare with other models i.e. single variable (GV) model was compared with UPV and RN models. Based on the results of this study, the suggested test (GV) is not recommended to be used in predicting concrete compressive strength as a single test. Nevertheless, this conclusion needs to be confirmed in addition to study the use of this test as an added-test to other NDTs to establish multi-regression models to predict concrete compressive strength.

## REFERENCES

- [1] ACI 318-11, Building code requirements for reinforced concrete, American Concrete Institute, Michigan, USA, 2011.
- [2] R. Demirboga, and M. Karakoc "Relationship between ultrasonic velocity and compressive strength for high-volume mineral-admixtured concrete," *Cement & Concrete Research*, vol. 34 pp. 2329-36, 2004.
- [3] A. M. Hassan, and S. Jones "Non-destructive testing of ultra-high performance fibre reinforced concrete (UHPFRC): a feasibility study for using ultrasonic and resonant frequency testing techniques" *Construction and Building Materials*, vol 35 pp. 361-7, 2012.
- [4] Subasi S, I. Sahin, and B. Comak "Prediction of compressive strength of concretes containing fly ash using non-destructive test results by anfis" *SDU Int. J. TechnolSci*, vol. 2(3) pp. 91-6, 2010.
- [5] T. Uomoto "Non-destructive testing in civil engineering" Tokyo: Elsevier Science Ltd, 2000.
- [6] G. Trtnik, F. Kavc, and G. Turk "Prediction of concrete strength using ultrasonic pulse velocity and artificial neural networks," *Ultrasonic*, vol. 49 pp. 53-60, 2009.

- [7] D. Lange, H. Jennings, S. Shah "Image analysis techniques for characterization of pore structure of cement-based materials" *Cement and Concrete Research*, vol. 24(5), pp. 841–53, 1994.
- [8] P. Gaydecki, I. Seliva, B. Fernandes, and Z. Yu "A portable inductive scanning system for imaging steel-reinforcing bars embedded with in concrete," *Sens Actuators*, vol. (84) pp. 25-32, 2000.
- [9] V. Huon, B. Wattrisse, and B. Maisonneuve "Investigating the thermo-mechanical behaviour of cementitious materials using image processing techniques" *Cement and Concrete Research*, vol. 39(6), pp. 529-7, 2009.
- [10] C. Basyigit, C. Bekir, K. Semsettin, and S. smail "Assessment of concrete compressive strength by image processing technique," *Construction and Building Materials*, vol. 37, pp. 526-6 , 2012.
- [11] K.B. Najim, Z.S. Mahmod, and A.M. Atea "Experimental investigation on using Cement Kiln Dust (CKD) as a cement replacement material in producing modified cement mortar," *Construction and Building Materials*, vol. 55, PP 5-12, 2014.
- [12] BS 1881-203" Recommendations for measurement of velocity of ultrasonic pulses in concrete" British standard Institution, 1986.
- [13] BS 1881-116 "Method for determination of compressive strength of concrete cubes" British standard Institution, 1983.
- [14] BS 1881:202 "Testing concrete Recommendations for surface hardness testing by rebound hammer" British standard Institution 1986.
- [15] N.T. Nguyen, Z. M. Sbartal, J. F. Lataste, D. Breysse, and F. Bos "Assessing the spatial variability of concrete structures using NDT techniques: Laboratory tests and case study," *Construction and Building Materials*, vol. 49 pp. 240-10, 2012.
- [16] [16] R. Castelman, *Digital image processing*, Englewood Cliffs: Prentice Hall, 1996.
- [17] [17] A.M. Neville, *Properties of Concrete*, London: Longman1995.

## Challenges of Network Management in Cloud Computing

Shivan Fazil Sabr

*Erbil Polytechnic University, Erbil*  
*shivan.fazill@gmail.com*

### ABSTRACT

Cloud computing is the latest trend in information technology that promises potential flexibilities. However network management in a virtual environment is different than management in a physical one. Invisibility of infrastructure creates management difficulties and consequently cloud computing is subject to many potential weaknesses. Providing analysis from a management perspective, this paper will first introduce cloud computing and its attributes. Secondly provide a literature review of network management requirements to support cloud computing. Thirdly critically evaluate the requirements, and addresses cloud weaknesses and their impact, providing key recommendations for network management in the cloud. Concluding with results achieved from current research.

**Keywords:** Cloud computing, FCAPS, Network Management, Security.

### 1. INTRODUCTION

The National Institute of Standards and Technology (NIST), defines cloud computing as a model for achieving universal, suitable, network access to a collective of configurable computing resources, to be accessed when needed, in such cases as: networks, servers, storage applications and services, quickly increased or decreased with least managerial effort or vendor interaction [1]. Anything which consists of service delivery over the internet is cloud computing, and the name is believed to be inspired by the cloud symbol, usually used to depict the internet in drawings. This technology enhances availability and is comprised of three service models, four deployment models and five essential characteristics. Cloud computing service models are: Software as a Service (SaaS), Platform as a Service (PaaS), and Infrastructure as a Service (IaaS).

**SaaS:** The client can use the provider's applications running through cloud infrastructure; these applications are accessed by multiple devices through interfaces such as browsers. The client does not have the control or ability to manage the cloud infrastructure encompassing networks, servers, operating systems, storage, or application capabilities. This tends to reduce cost of hardware and software development, operation, and maintenance [2].

**PaaS:** The client can use the cloud infrastructure to deploy its own developed or requested applications developed via programming languages and tools provided by vendor. The client cannot control or manage the provided infrastructure such as network, servers, operating systems, or storage. Instead the client can only control deployed applications and the configured environment where the application is hosted. This reduces the cost of buying and managing software and hardware components of the given platform [2].

**IaaS:** The client can increase processing power, memory, networks, and additional essential resources for client to deploy and run software such as operating systems and application programs. Although client cannot manage or run the given infrastructure, it can control operating systems, storage, deployed applications and may be control over some network components. This is to avoid buying, managing and housing hardware and software components [2].

### 1.1 DEPLOYMENT MODELS

- **PRIVATE CLOUD:** The cloud exclusively runs for an organization. The organization manages it or by a third party and may exists on premise or off premise [1].
- **COMMUNITY CLOUD:** The cloud shared by group of organizations to support their community with common concerns such as: mission, security requirements, policy, and compliance concerns. The organizations or a third party manage it and may exist either on or off premise [1].
- **PUBLIC CLOUD:** The cloud is for the public or big groups of industries and it is possessed by an organization providing cloud services as a business [1].
- **HYBRID CLOUD:** Comprises of two or more of the above cloud models (private, community and public) each with their unique entities however bound by standards or proprietary technology to ensure data and application portability [1].

### 1.2 CHARACTERISTICS

- **ON DEMAND SELF-SERVICE:** Computing resource capabilities such as network storage and server time unilaterally provisioned by consumers when required automatically, without human interaction [1].
- **BROAD NETWORK ACCESS:** Capabilities made available on the network and can be retrieved via standard mechanisms to stimulate use via different client platforms such as: personal computer, laptops, and mobile phones [1].
- **RESOURCE POOLING:** The sharing of provider resources for several clients in a multitenant fashion. Resources dynamically assigned based on demand. It is location independent, in which client may have no idea about the actual location of the given resources. Examples of resources are storage, memory, processing power, network bandwidth and virtual machines [1].
- **RAPID ELASTICITY:** Capabilities are instantly and elastically provisioned, sometimes automatically scaled out and rapidly released to scale in. These capabilities are often unlimited so as to be used by the client at any time [1].
- **MEASURED SERVICES:** Clients are charged based on their usage of computing power, bandwidth use and/or storage in a metric model. In order to provide transparency for the client and the provider, resource usage can be monitored, controlled and reported [1]. Enterprises are interested in cloud computing, because there are several reasons and constraints driving them to look for more innovative, cheaper and more flexible ways of conducting business. With cloud computing, they benefit from lower implementation and management costs, save on initial investment costs and operational cost reduction.

## 2. LITERATURE REVIEW

Cloud computing promises an omnipresent access to shared resources such as services and applications that are delivered over a network to various customers. These resources are available via interfaces deployed within the cloud, not spread over single machines connected to the internet. However due to the high level of abstraction in cloud infrastructures, it potentially introduces unpredicted performance behaviours. Nonetheless, for network management to support cloud computing infrastructure, a very high performance is required to fulfill the need of all workloads [3]. Sharing resources on a large scale distributed infrastructure may reduce distinct workload variability and only a high performance can facilitate the execution of all the tasks. Varying individual workloads and resource demands at given workload conditions leads to performance prediction difficulties. Enabling users and applications to store data on network, thus dealing and transporting large volumes of data on the cloud or among clients is a challenging issue, network management must be capable and guarantee that data is automatically processed and transferred when and where it is needed [2]. Automation of tasks is another requirement of a network management to support cloud computing. An environment with human interference to assign bandwidth, communication links or resources to process tasks cannot be considered as cloud computing [2]. Therefore an accurate network view is fundamental and must be integrated to cloud management; to support and enable these services which provide flexibility to cloud and also augment the use of the available resources and communication infrastructure efficiently. Speedy connections are also required to run at the ultimate bandwidth with least transmission latency [4]. Generally users and providers should understand performance redundancy and different option costs, since applications do not have the same features. Some need basic capability, and others may need enforcement of specific network performance. An efficient configuration management to facilitate and ease software deployment process is essential, as it is usually a major challenge. Therefore the client must be able to revert to the previous image, shape or able to upload a new one efficiently during bug problems facing the software running in the cloud. [4]. Cloud computing is about service monitoring as computing capacity increases and decreases based on weight and traffic, meanwhile network and server infrastructure remain invisible. While current network management is about ensuring if network and server infrastructure are functioning appropriately, but in cloud computing network management focus moves from infrastructure management to managing service availability and performance. The need for provision, scalable network and management encourages migration to cloud. However, the client is reliant on the vendor in a network management system to trace the breakdowns [5]. Standard cloud usage information statistics by vendor should be in a format compatible to a client's network management software. The client must use network management systems with capabilities so that they connect their network management system to the vendor's one. Sometimes the vendor and client may use the same cloud computing infrastructure. Managing in a cloud environment has drawbacks if vendors are not transparent about the way they have deployed their infrastructure, because there is a possibility that both management and managed services to use the same infrastructure. Network management systems are used to concentrate on monitoring and measuring of technical metrics and separate node trends and infrastructure components. Yet to ensure that business

operations run smoothly in the cloud environment, the network management has to shift its focus from monitoring technical infrastructure to business service availability and performance monitoring [6]. In fact, network management must include a complete service monitoring view rather than only monitoring individual node performance or components.

### 3. CRITICAL EVALUAION

Advancements in virtualization and virtualization software have led to the emergence of cloud computing during the recent years [7], and with virtualization the user has access to seemingly endless amounts of resources. Achieving the true potential benefits of cloud computing, there has to be successful application delivery and around the clock service availability. In cloud computing, the responsibility of network management is delegated to the cloud service provider to ensure successful delivery and availability. But the virtual network becomes the real target of network management, as it may be harder to manage a virtual network in comparison to a physical one [8]. Clients may have no clue about network management in cloud, since managing unseen virtualized infrastructure is more difficult than the physical infrastructure and clients are used to having staff managing it for them. While hereinafter the responsibility is shifted and delegated to the vendor to look after infrastructure, security and application delivery [10]. It is difficult to state how these resources are available, seeing as everything is virtualized in cloud computing. The invisibility of infrastructure makes it difficult to ensure that the infrastructure works properly, as there is no physical hardware on client's premises. Thus monitoring performance is challenging. Therefore, to ensure reliability and application delivery, network management needs access to the routing and traffic dynamics spanning both enterprise and inter domains, but traditional network management techniques are incapable of providing that sort of visibility [9]. Unlike the traditional model of computing, in cloud computing clients are no longer able to imply their security control [11]. Service providers are tasked instead with security controls and preventing clients from accessing another's data. Clients face difficulties in checking whether appropriate security measures are implemented and if certain services are available around the clock. The enhancement and maintenance of security functionalities raise clients concerns, since the applications are hosted on provider owned servers or deployed on a third party cloud infrastructure. Data is perhaps the most valuable asset for businesses nowadays; organizations protect data by imposing access control policies. But in cloud computing, many clients' data is stored together in a service provider's storage. Providers often supply public cloud services to the general public, i.e. many clients share the same boundary. Moreover to maintain high availability, providers replicate data across several locations and clients will lose visibility and control of their data. Consequently in cloud computing there exists several weaknesses and security issues which require detailed consideration. Some of these weaknesses and security issues are discussed below:

- **DATA SECURITY:** Prior to the emergence of cloud computing technology, specifically in the on-premise application deployment model; sensitive data resided within an organization's boundaries. Therefore, data policies are developed by organizations to address physical, logical, and access control. Adoption of cloud computing has the implication of the potential release of ownership of data, as the data is no longer within the firm's boundaries. Security concerns rise as data owners cannot place or impose their security



policies anymore. As a result, it is the responsibility of the cloud service provider to implement and enforce data security policies to prevent unauthenticated and unauthorized access to data, and from malicious insiders. This can be done via strong user authentication methods. Otherwise any vulnerability is subject to be exploited by a malicious user to obtain unauthorized access [12].

- **DATA SEGREGATION:** The multi-tenant environment of cloud enables many users to stock their data using applications in the SaaS cloud model. Accordingly, various user data is stored in the same data repositories. This makes data intrusion possible where one user can access another user's data. Intrusion can be achieved through hacking techniques exploiting application loopholes or by inserting client executable codes into the system. The capability of intruders to access other's data would be high, if the targeted application permitted execution of such programs without further verification. Each user's limit within the service model should be assured on both the physical and application level, so that data is adequately isolated between different users to prevent intrusion. Segregation vulnerabilities can enable malicious intruders to avoid security checks and as a result another user's sensitive data can be accessed by an unauthorized user [13].
- **DATA BACKUP AND RECOVERY:** A major security issue in cloud computing technology is data loss. Disasters can potentially be very harmful to enterprises especially when resulting in loss of sensitive data. Hence, quick data recovery ought to be facilitated and the client's data must be regularly backed up with the service provider being accountable for this. Meanwhile when disaster strikes, clients need to know about the fate of their data. This can be prevented via appropriate replication of data and providing a reliable media storage. Sometimes insecure storage and insecure configuration in a given service raise vulnerabilities that may be exploited in order to achieve access to an enterprises sensitive data, stored in backup repositories [14].
- **CONFIDENTIALITY AND PRIVACY:** only authorized parties or systems must be able to access protected data. Any unauthorized disclosure of information may implicate the data owner. Cloud computing augments the risk of data compromise, because of the large number of parties and architectures involved, consequently the number of access points are increased. In such a situation if data control is assigned to the cloud, the risk of data compromise increases because data may be accessible by an increased number of parties. Sometimes the content of user's storage might be stored by a single or multiple cloud service providers. Thus organizations sharing their information on the cloud face confidentiality issues as well [13].
- **AVAILABILITY:** System availability is the capacity of any system to continue functioning even when misbehaviours by authorities take place. The system must continue operate even during security breach circumstances. It includes availability of software, data, and hardware to be available for authorized users upon demand. Cloud computing depends on ubiquitous network availability so that users hardware infrastructure needs to be leveraged. Therefore, the network is loaded with data retrieval and processing. The service provider must guarantee the availability of information and information processing to clients when demanded, because cloud services are heavily depend on network availability and resource

infrastructure. The cloud architecture should be multi-tier, support load-balanced application instances and be able to run various servers. It should be resilient to hardware and software failures and denial of service attacks [15].

- **DATA ACCESS:** Data access is about security policies provided to the user during data access. Business organizations use cloud provided by a provider to carry out their business processes. Assuming that an organization has its own security policies about data access such as which employee can access what sort of data, as there might be employees not allowed accessing certain sets of data, security policies must be enforced by the cloud to prevent data intrusion from unauthorized users. Therefore, the provided service must be flexible enough to integrate policies forwarded by the organizations. Organizational boundaries need enforcement in the SaaS model amongst organizations sharing cloud, because each will forward different security policies regarding data access [14].
- **DATA BREACH:** Often various users and business organizations share the same cloud to store their data, thus any breach to the cloud environment can potentially attack all clients data. This makes any cloud environment a valuable target. Even though cloud computing providers can claim to provide better security procedures than traditional mean, yet the risk of intruders is still high. Because insiders still have access to data but in different way. Although insiders may not be able to directly access any databases, this cannot guarantee against insider breaches which can have severe impacts on cloud security. Insiders have access to a lot of data and one breach can be enough to disclose client information [13]. Moreover, the International Standard Organization (ISO) has a model which defines five functional areas for network management: Fault management, Configuration management, Accounting management, Performance management, and Security management (FCAPS) [8]. Although FCAPS is a standard and straightforward model for network management, there seems to be differences when normal network management is compared to network management in the cloud environment. In order to provide a clear insight, functional areas are separately compared in both normal network management and cloud computing network management. Firstly for fault management in normal network management, there is information about faults and their types and there is a need for the initial cost of physical hardware, but in the cloud computing environment the client has no information about fault occurrences and there is no need for the initial cost of hardware [8]. Secondly in configuration management for normal environment, everyday operations are controlled and monitored, coordination of hardware and programming changes. New programs, adjustment of existing, and the elimination of outdated systems and programs are also coordinated. But in cloud environment the responsibility of all daily operations including control and monitoring are delegated to a vendor and both hardware and software modifications are automatically coordinated. For new programs, adjustment of existing ones or deletion of outdated ones are all automatically aligned.

Thirdly the role of accounting management in normal network management is to distribute resources among users, reduce or minimize operation costs via the effective use of system availability and ensure appropriate billing for users. While in

cloud computing resources and services are distributed among clients and the client is not responsible for any operational costs. It is a pay per use fashion and the client is charged for used storage, bandwidth and processing power. Moreover for performance management, performance is not flexible in a normal network but still full performance log and data can be accessed, and analysis can be performed when needed. However network in cloud environment has a flexible performance with limited access to performance data collection and performance is consistent. Finally security management in normal network management is responsible for the network's physical security. Security breaches can be analyzed and reported, and security alerts may be provided. However in cloud environment, security is managed by vendor and only the cloud provider has physical access. Security breaches might not be reported, and no security alerts provided. From these differentiations in both normal network management and network management in cloud environment, it can be concluded that FCAPS is still limited in its capacity to address all management tasks even in normal network management, yet it is more difficult to imply it on network management in cloud computing.

#### **4. RECOMMENDATIONS**

Network management in cloud computing remains a crucial aspect requiring detailed attention from both client and vendor. Despite relinquishing much of the physical control and management to the vendor, it is highly recommended for clients to assume their share of responsibility and oversight in respect to network management. Some key recommendations for improving network management in cloud computing are:

- Managing network traffic is key to improving network performance (who is using it, how much they are using, and what they are using it for) to assess the impact on the performance of business critical apps and services.
- Monitoring your network performance is paramount, excess latency or jitter can have significant negative impact on service availability and performance.
- Utilize Quality of Service (QoS) for multitenant networking to accommodate the needs of users with different QoS requirements.
- Both client and vendor should keep track of configuration changes when made for auditing purposes and a clearer oversight.
- Documenting how network configuration changes is important as it allows the client to know how a device is currently configured and how it was configured. Past configurations can often help in troubleshooting should a problem occur after specific changes have been implemented; current configurations are important should a device fail.

#### **5. CONCLUSION**

Cloud computing is a new computing paradigm promising many potential benefits especially in eliminating the initial cost in the present day's fluctuating economic situation. Similar to other new technologies cloud computing has a weakness in terms of security issues. However there ought to be appropriate solutions to tackle these weaknesses in order to utilize this computing architecture. Since clouds are hosted and managed by vendors, there ought to be more collaboration between clients and vendors. Clients can help by managing equipment on their premises and on the other end it is the vendor's duty to ensure that the end

applications are functioning well. An end to end management of the cloud infrastructure requires collaboration of both client and vendor to achieve a high level fault and configuration management automation. Moreover standards are required for measurement of cloud computing and other standards to guarantee quality of service in cloud. Training and educating staff is also helpful to make personnel aware of the latest trends, developments and issues in cloud computing. Current research has achieved different ways of securing cloud environment such as using cryptographic techniques for securing data, and it is expected that new researches will continue to address standardization issues more.

## REFERENCES

- [1] Peter M., Timothy G., (2011) “The definition of cloud computing”, National Institute of Standards and Technology special publication 800-145, 7 pages.
- [2] Jim, Metzler. (2015.) “A guide for understanding cloud computing” [online] available at: [Http://it.bluecoat.com/doc/12437\\_](Http://it.bluecoat.com/doc/12437_) [accessed 11 January 2016].
- [3] Antonopoulos Nick, Gillam, Lee (Eds.) (2010). “Cloud computing, principles, systems and applications”, London, Springer.
- [4] Nabil Damouny, (2015). “Networking processor requirements in cloud computing environments” [online] available at: <http://esj.com/articles/2011/02/01/processor-requirements-cloud-computing.aspx> [accessed 11 January 2016].
- [5] Jack Hughes. (2013). “How will cloud computing change network management” [online] available at: <http://www.openxtra.co.uk/blog/how-will-cloud-computing-change-network-management/> [accessed 11 January 2016].
- [6] Vikas Aggarwal, (2015). “Will cloud computing confuse network management?” [online] available at: <http://soa.sys-con.com/node/1203518> [accessed 12 January 2016].
- [7] Marston, S., Li, Z., Bandyopadhyay, S., Zhang, J., Ghalsasi, A., (2011) “Cloud computing - The business perspective”. *Journal of Decision Support Systems* 51 (2011) 176–189.
- [8] Richard J. Burke. (2014), *Network management concepts and practice: A hands-on approach*, New Jersey, pearson prentice hall.
- [9] Jim Metzler, (2014). “Virtualization: Benefits, challenges and solutions”, [online] available at: [http://www.vioptim.co.uk/storage/Virtualization\\_Benefits\\_Challenges\\_and\\_Solutions\\_WP.pdf](http://www.vioptim.co.uk/storage/Virtualization_Benefits_Challenges_and_Solutions_WP.pdf) [accessed 13 January 2016].
- [10] Greg Ferro, (2013) “Networking is cloud ready, but where is network management?” [online] available at: <http://etherealmind.com/networking-cloud-ready-software-needed/> [accessed 12 January 2016].
- [11] Wayne A. Jansen, “Cloud Hooks: Security and privacy issues in cloud computing”, *Proceedings of the 44th Hawaii International Conference on System Sciences – 2011*, IEEE Computer Society.
- [12] Dorey PG, Leite A, “Commentary: Cloud computing – A security problem or solution?” *Information Security Technical Report* (2011), doi:10.1016/j.istr.2011.08.004.
- [13] S. Subashini, V. Kavitha, “A survey on security issues in service delivery models of cloud computing”, *Journal of Network and Computer Applications* 34 (2011).

- [14] Teneyuca D, “Internet cloud security: The illusion of inclusion”, Information Security Technical Report (2011), doi:10.1016/j.istr.2011.08.005
- [15] D. Zisis, D. Lekkas, “Addressing cloud computing security issues”, Future Generation Computing Systems (2011), doi: 10.1016/j.future.2010.12.006

## Comparing Routing Protocols in Opportunistic Networks

Shivan Fazil Sabr

*Erbil Polytechnic University, Erbil*  
*shivan.fazill@gmail.com*

### ABSTRACT

In opportunistic networks (OppNets) nodes are only intermittently connected and there is no existing end to end path between the sender and the receiver. Disconnections among the nodes are considered as norm, not exception. Mobile objects exploit direct contact for message transmission without relying on an existing end to end infrastructure, therefore in such circumstances routing is considered to be a challenging issue. This paper reviews the main routing approaches in OppNets and the algorithms laying in each approach: context-oblivious, mobility-based, and social context-aware routing. Context-oblivious routing contains flooding algorithms that route blindly. The mobility-based algorithms exploit node mobility information and patterns to make forwarding decisions. Social context-aware protocols, besides exploiting a nodes mobility information, also consider the social aspect of each node as an important parameter to route messages. The first section of this paper briefly introduces the concept of OppNets and its routing approaches. The three subsequent sections cover the three main routing categories by looking at individual algorithms that lay in each class and how they work. The fifth section compares and evaluates the categories against each other and considers the ideal circumstances for each protocol. The final section draws conclusions covering the major protocols of each class.

**Keywords:** Opportunistic Networks, Routing in Opportunistic Networks, Routing Protocols.

### 1. INTRODUCTION

OppNets are made with an assumption that people, animals or devices are carrying mobile devices without depending on existing network topology. Disconnections and mobility in OppNets are considered the norm, not exceptions, unlike the internet[1]. The main challenge in OppNets is how to route messages from their source to their destination, when the end-to-end link is absent or does not exist during transmission. During node mobility, when nodes come close to each other, devices can create a small mobile ad hoc network. This might not last for a long time, since nodes may be frequently isolated from each other. In other words nodes are only intermittently connected to each other, and this can change dynamically with time. End-to-end paths can only exist when the sequence of connectivity graphs over time intervals overlap. This implies a message can be sent over an existing link which might not last for long. Sometimes end-to-end connectivity between both the source and the destination nodes is absent during message transmission. Thus the message is buffered at the next hop waiting for the next link to come up; this is repeated until the message reaches the destination node. This is known as a store-carry-forward routing pattern and has imposed a new model

of routing in which forwarding decisions are made locally, and future connectivity is to be predicted. In brief, OppNets use mobility as a technique to enable communication between disconnected nodes [1]. Hoang & Silvia[2] state that routing schemes in OppNets should provide reliability even when network connection in intermittent or end-to-end connectivity is temporarily absent. Since communications exist arbitrarily in OppNets and without prior knowledge, circumstances dictate that neither scheduling routing, nor mobile relay approaches can be implemented. Nonetheless, in these circumstances, flooding based protocols seem to be the best option. However, this scheme can be costly in terms of energy consumption and traffic overheads. Routing performance improves when information on network topology and nodes mobility patterns are exploited for taking forwarding decisions: that is the context information of the networks. Context information can include a variety of parameters based on distinct protocols. It can be a nodes mobility patterns, the communities which they belong to, or a nodes occupation information such as workplace, profession and so on. In the following section this paper provides detail review of the primary routing protocols in OppNets from blindly routing approaches to intelligent ones. Thereby critically reviewing and comparing routing in OppNets in three ways: context-oblivious routing, mobility-based routing and social context-based routing.

## **2. CONTEXT-OBVIOUS ROUTING**

The context-oblivious routing category comprises of flooding based algorithms, where the algorithms route blindly, or sometimes with techniques to control the flood. In flooding based routing, a source node sends a request packet to all outgoing links. Each node then receives a request packet and forwards the packet to its outgoing links, except the node equivalent to the incoming link where the packet originally came from. Request packets may arrive to the destination taking different route at a different time. Routing protocols in the context-oblivious category generates high overheads and leads to network congestion. Flooding based routing technique is advantageous due to the simplicity of finding a route, especially as it has the lowest delay ratio for connection requests as it does not require any information regarding network topology or context information. Yet in contrast, it causes network congestion due to the large number of control packets in the control channels. In addition, flooding based routing is costly in terms of memory and energy consumption, as it floods all the nodes across the network. However, performance remains of the utmost importance in OppNets due to device constraints.

Epidemic protocols are the classic example of algorithms in this class, where nodes in the network contact each other and perform a pairwise exchange of information to deliver the message to the destination. In this routing scheme, when a node receives a message, it forwards a copy of it to all encountered nodes. The mobile nodes spread the message all over the network and eventually all the nodes have a copy of the same message. This algorithm does not supply delivery assurance, yet it is believed to be the best approach to reach the destination node [3]. Epidemic algorithms detect the optimal path for message delivery to the destination when there is an adequate node buffer and bandwidth for communication between the nodes. This is due to the capability of the epidemic scheme to explore available paths for message delivery and enable redundancy to avoid node failures [4]. There are some attempts to address this issue. One way is to use a hop counter, in each

packet's header and decrement it at every hop, when packet counter become zero, it has to be discarded. Another way is to set Time To Live (TTL) on every packet similar to an epidemic algorithm. Epidemic routing adjusts basic flooding to mobile OppNets, where each node has a list of messages it carries to be delivered. When a node encounters another, they exchange the messages they do not have in common, this way messages spread to all the nodes across the network. The packet is delivered to its destination when one of the nodes carrying a copy of the message first meets the destination node. The packet continues to be copied from one node to another until its TTL expires. Another flooding based technique is network coding scheme. In this scheme, a message to be transmitted is transformed to another format before transmission. The design of the coding based scheme embeds additional information within the coded blocks to enable the reconstruction of the original message when delivered. Unlike to other schemes, which depend on the successful delivery of entire blocks, this scheme considers a delivery to be successful when a sufficient number of blocks have been transmitted to rebuild the original data. This scheme is more robust in conditions where network connectivity is very poor, such as in the worst performance delay situation, but less efficient when the network is well connected and delay performance is very low [2].

Spray and Wait is another method for routing in sparse networks which is a controlled replication. In this approach a small number of message copies are distributed to some relays. Each relay carries the message until it encounters with the destination node or the TTL of the message expires. This scheme explores the sparse network efficiently with specific number of relays in parallel to the destination with a low resource usage per a packet [2]. This algorithm consists of two phases, spray phase and wait phase. In the spray phase the source node forwards L copies of the message to the first L encountered nodes. Then it reaches the wait phase, waiting for the delivery confirmation. In this phase all nodes that received a copy of the message wait to meet the destination node directly to deliver data to it. When data is delivered to the destination node, delivery acknowledgement is sent back via the same method.

### **3. MOBILITY-BASED ROUTING**

Routing protocols in the mobility-based class of OppNets exploit node mobility information and patterns to make forwarding decisions. The effectiveness of routing in OppNets is highly dependent on node mobility. It has been proven that ad hoc networks performance in message routing is improved with node mobility, especially when efficient routing techniques are deployed [2]. Routing in the mobility-based routing class comprises of various protocols. Protocols that lay in this category exploit context information such as mobility patterns and places nodes often visit. Thus availability of context information is vital for algorithms, since that is what they base their forwarding decisions on. The protocols that fall in this category are Probabilistic Routing Protocol using History of Encounters and Transitivity (PRoPHET), Meeting and Visits (MV), Moby-Space, Bubble Rap, MaxProb and Context-aware Adaptive Routing (CAR). PRoPHET is the evolved version of epidemic algorithms, introducing the concept of delivery predictability. This algorithm is similar to epidemic in its manner of functioning when two nodes meet as it exchanges its vector summary identically to an epidemic algorithm. Additionally they also exchange another piece of information which is their probabilistic metric delivery predictability [5]. Lindgren et al. reject the concept that node movement is random. Instead they claim that node movement can be predicted



according to its repetitive behavior pattern. For instance a node having already visited a location for several times, it is more likely to visit that location again. MV exploits information on node mobility patterns and places nodes repeatedly visit. It also explores information regarding meeting with peer nodes and locations they visit. The information on meetings and visiting places is stored in each node and it is used to estimate probability of message delivery [6]. MV realizes meeting frequency between nodes, in which nodes remember their paths (visits), as well as other nodes they met along the way. Each node saves a variable for the nodes they have encountered indicating the likelihood of delivery to that particular node. When node A meets B directly, they set the delivery probability for each other to 1 and eventually synchronize their set of variables. The delivery probability decreases in time, and is refreshed occasionally when meeting other nodes with higher probability. If A meets B again, synchronization takes place again and their delivery predictability is reset to 1. Message selection for forwarding is based on the probability of an encountered node to successfully deliver a message to its destination. Hoang & Silvia [2] believe that delivery probability depends on previous observations of both meetings between the nodes and their visits to specific geographical locations. The Moby-Space algorithm explores node mobility patterns as context information. It uses a multidimensional Euclidian space to represent possible contact between two nodes on each axis. The probability of contact to take place is measured by distance along the axis. Nodes close to each other in Moby-Space have similar sets of contacts, and the best node for forwarding the message is the one which is as close as possible to the destination node in this space [1]. Bubble Rap exploits context information assuming nodes belong to social communities [7]. This algorithm prefers nodes that belong to the same community of the destinations as good forwarders. In case the preferred node is not found, the message is then forwarded to an increasingly sociable node with a higher probability of contact with nodes belonging to the same community as the destination node. Communities are automatically detected and labeled through the contact patterns existing among the nodes.

MaxProp is used by nodes to schedule packet transmissions to their peers in order to find out which packet to delete when their buffer space is nearly full. Packet scheduling determines the path likelihood to other peers according to historical data. This algorithm uses other complimentary mechanisms such as acknowledgements, head-start for new packets, and lists of previous intermediaries[8]. This algorithm also exploits some context information such as frequency of meeting between the nodes and frequency of visits to specific physical locations. The Context-aware Adaptive Routing algorithm uses Kalman filters to combine and evaluate various dimensions of the context to make routing decision. The context is based on a measurement performed by nodes periodically which sometimes relate to connectivity. The multi-attribute framework defined by CAR encompasses context information regarding the rate of connectivity change, a neighbor node's delivery probability to the destination, and device related information such as battery life [6].

#### **4. SOCIAL CONTEXT-BASED ROUTING**

The Social context-aware routing technique produces a way to overcome the process of routing that leads to delays in the OppNets and the probability of information could reach the destination is very low that occur due to the inconsistent

mobility network. This technique is different from the previous techniques in opportunistic routing because it keeps exploiting the context information of the users similar to mobility-based class, but it creates the relationship by exchanging context information between the nodes to achieve end to end communication. The relationship plays an important role between nodes; their interaction will result in sending information to the destination. It is a very general approach because the algorithms that lie in this technique can actually work in any environment according to their needs. In this approach routing algorithms search for those peers that have similar attributes so the message can be delivered to the destination. This technique eliminates flooding routing which is used in context-oblivious routing, which leads to congestion in bandwidth and exposes high utilization to the network. In social context-aware routing only the content information is sent to the neighbor who has the highest probability to send the message further to the desired destination [7].

A History Based Routing Protocol for Opportunistic Networks (HIBOp) is one of the algorithms in context-aware class of routing. The main purpose of this routing technique is to collect and manage the context information and create a way through which the user can interact and create a relationship with every user. It keeps the entirety of the users information in order to produce end-to-end messages. HIBOp maintains pairs of attributes for exposing any node in the network and these details are stored in the identity table. The node's information is then used to achieve end-to-end communication. The HIBOp believe in the automatic methodology used to gather and manage the context information, and nodes share their information with each other when they meet with other nodes. Thus every node has all context information regarding the past and updated information of each node, allowing the interaction and message sending becomes easier. HIBOp gives idea three types of tables for the context information of users. The first one is the identity table in which the node's own attributes and features are stored like name, address, and city. Secondly, the current context table that indicates data regarding the neighbors of the user or node and makes a combination of the set of identity tables. Current context tables provide the most up to date story of the table of users in the networks. The third table is the history table that shows the idea of past information of the node [9]. HIBOp route the messages in a way where there is a correlation between attributes of the destination nodes and the information of each node. When routing occurs if the peer shows that the attributes it contains are the highest matching in the identity table attributes, then this peer or node can directly send the messages to the destination. But, if the attributes match with current context table and the history table then it shows that peer is no more than a good forwarder. Higher matches also depend on the attributes, because not all the attributes are equal. For example 'home addresses' will show high probability towards the destination rather than the 'city' attribute in which both sender and receiver may exist. That's why HIBOp introduces a weight system to each attribute [10].

The Probabilistic Routing Protocol for Intermittently Connected Mobile Ad hoc Network (PROPICMAN) algorithm is another class of social context-aware routing approach. This algorithm is based on the context information, permitting the sender to select the neighbor through which the message has the highest probability of reaching the destination. Routing protocol traditionally forwards the message in a simple way, choosing the neighbor that has the best path to the destination. However, due to the arrival of mobility routing and opportunistic routing networks,

the routing behavior have been changed. There are some goals of the PROPICMAN algorithm which include distributing the information opportunistic routing, in a probabilistic manner, efficiently [11]. It minimizes the amount of resources consumed in sending any information and maximizes the percentage of messages that are delivered to the destination. To handle this task the utilization of the probability of nodes is required so that it can reach the destination. In this algorithm the sender does not carry any information regarding other nodes. It only knows the decision that is to be taken against the routing for the destination. PROPICMAN treats the user profile as a very flexible element, so the attributes of the user profile are called evidences. In the PROPICMAN algorithm if the sender wants to send the data the sender must have attributes regarding its destination node, for reaching the destination the algorithm must create some strategy to select the best forwarder to the destination. To implement the strategy the sender must have some attribute-related information of the destination profile. From the evidences or attributes the sender builds the message header. Then this header is sent to each neighbor node. Each neighbor receives it and compares it with all values. All the nodes will inform their matching elements and weight of attributes. From this point the highest probability node will be obtained, through which the message could be sent to the destination [11].

## **5. COMPARISON**

Context-oblivious protocols provide a very good delivery ratio, with low delay and are easy to implement, but at the cost of excessive transmission. Something that leads to high network congestion and resource consumption. They are a wise choice in circumstances where network congestion and resource consumption are not constraints, and where information on nodes mobility patterns and network topology cannot be exploited. On the one hand, the mobility-based protocols are more suitable in circumstances where device and network bandwidth are important constraints. On the other hand, they are more difficult to implement and often provide an average delivery ratio. They are particularly useful when device constraints and network traffic are taken into account. Mobility-based protocols are better for conditions where information regarding network topology and nodes mobility patterns are available, given that routing performance improves when information about network topology and node behavior are efficiently exploited. Finally, the social context-aware class is suitable when a node's social behaviors are known and where memory and bandwidth are important constraints. The table below summarizes and compares the various routing protocols in context-oblivious, mobility-based and social context-based routing protocols in OppNets.

TABLE 1.  
Comparing Routing Protocols in Opportunistic Networks

	Algorithm	Decision based on	Disadvantages	Advantages
CONTEXT-OBLIVIOUS	Flooding	Route blindly or sometimes with techniques to control the flood.	Network congestion, consumes memory, energy.	High delivery ratio.
	Epidemic	Forwards a copy of message to all encountered nodes.	No delivery assurance	Detects the optimal path for messages delivery.
	Spray & Wait	Distributing message copies via relays	Excessive transmission	Delivery acknowledgement
MOBILITY-BASED	PRoPHET	Probability obtained from previous meetings	High message overhead	Moderate delivery ratio.
	MV	Encountered node can successfully deliver to destination	Excessive buffer space usage	Good link capacity,
	MobySpace	Forwarding is done to nodes with similar mobility patterns to the destination node	High bandwidth consumption	Good delivery ratio, moderate delay
	Bubble Rap	Nodes belonging to same community of destination node	Message delay with excessive cost	Low overhead
	CAR	Node's delivery probability to the destination	Low prediction accuracy when context information is unavailable	Efficient with context information
	MaxProp	Previous node meetings and updated route estimation	High processing cost	Efficient buffer storage, delivery acknowledgement
	SOCIAL CONTEXT	HIBOp	Shares information when meet with other nodes	Network congestion
PROPICMAN		Forwarding to the node with the best path to the destination	High message overhead	Minimum resources consumption

## 6. CONCLUSION

This paper provides a review on routing in OppNets and how routing decisions are taken on the basis of assumptions rather than relying on an existing network. The main challenge is transmission on a consistent basis instead of occurring on an intermittent basis. To cover up the challenge of sending messages to the destination without the existence of communication between them, opportunistic routing techniques are used to stabilize the communication between the nodes. These techniques provide reliability even when there is no connectivity. During the forwarding phase, if the context information about the network topology is exploited, routing performance improves. This review focused on the study of the primary routing protocols and how routing is improved from naïve in context-oblivious to intelligent in mobility-based and social context-aware. The protocols of each class of OppNets is reviewed and covered in detail. Context-oblivious techniques have been discussed, in flooding approach messages are forwarded to all nodes except the incoming. This shows that flooding is simple approach in finding the routes, but due to that, network congestion from controlling packets and routing heightens energy consumption. Epidemic routing approach is classic example in which nodes update all encountered nodes with a copy of the message, but it does not provide delivery status. For the detection of the optimal path in epidemic routing, a hop counter is introduced in the header of the packet and it decrements at every hop and discarded when it reaches zero. The other approach is TTL, where only uncommon messages between the nodes are exchanged and spread to the other nodes. The network coding scheme is very useful where there are delay situations in the network as actual messages have to be transformed before transmission to the destination. Multiple copies of the messages are distributed and the message is copied until received at the destination node.

Several techniques in mobility-based routing were reviewed and consequently effective routing is very much dependent on node mobility in this class. Through mobility-based routing, network performance is improved whenever their techniques are applied in the network. Basically mobility-based protocols exploit context information and the availability of context information is crucial. PROPHET is quite similar to epidemic in forwarding, but it differs when the nodes exchange their probabilistic metric. The other technique, MV, also exploits the context of a node's visit and information on a node's visit to locations. In Moby-Space similar techniques are applied, and the best node was the one which is closest to the destination node. Bubble Rap prefers nodes belonging to the same community of the destination node and is the best node to forward the message to the destination. The last class, social context-aware, has two protocols: HIBOp and PROPICMAN. These approaches are used to overcome delays due to the inconsistent mobility network. The main purpose of both protocols is to collect and manage the context information and to exchange the same information amongst the nodes. Social context based routing is a new approach and it requires more attention. The first section of this paper briefly introduced the concept of OppNets and its routing approaches. The three subsequent sections covered the three main routing categories by looking at

individual algorithms that lay in each class and how they work. The forth section compared and evaluated the categories against each other and considering the ideal circumstances for each protocol. The final section draws a conclusion covering the major protocols of each class.

## REFERENCES

- [1] A. Verma and A. Srivastava, "Integrated routing protocol for opportunistic networks", *International Journal of Advanced Computer Science and Applications*, vol. 2, no. 3, pp. 85-92, March 2011.
- [2] A. N. Hoang and G. Silvia, "Routing in opportunistic networks", *International Journal of Ambient Computing and Intelligence*, Vol. 1, no. 3, pp. 1-4, 2009.
- [3] R. Zhi., et al, "A high-efficiency low-delay routing algorithm for opportunistic networks", *Network Infrastructure and Digital Content*, 2nd IEEE International Conference, pp.1035-1041, September. 2010.
- [4] X. Zhang., et al, "Performance modeling of epidemic routing", *Computer Networks*, vol. 51, pp. 2867–2891, 2007.
- [5] A. Lindgren., et al, "Probabilistic routing in intermittently connected networks", *Mobile Computing and Communication Review*, vol. 7, no. 3, pp. 19-20, July, 2003.
- [6] Kurdi, Shivan Fazil. "Mobility-Based Routing in Opportunistic Networks," *International Journal of Technology Diffusion (IJTD)* 3 (2012): 2, accessed (January 17, 2016), doi:10.4018/jtd.2012040103
- [7] A. N. Hoang and G. Silvia, "Context information prediction for social-based routing in opportunistic networks", *Journal of Ad Hoc Networks*, vol. 30, pp. 1-3, May, 2011.
- [8] B. Chiara, C. Marco and P. Andrea, "Social-based autonomic routing in opportunistic networks", Springer *Autonomic Communications*, pp. 45-48., 2009.
- [9] C. Boldrini., M. Conti and A. Passarella, "Exploiting users' social relations to forward data in opportunistic, Pervasive and Mobile Computing, 4(5), pp. 633-657, 2008.
- [10] C. Boldrini, "Design and Analysis of Context-aware Forwarding Protocols for Opportunistic Networks" *MobiOpp '10* proceeding of the second international workshop on Mobile opportunistic networks, 2010.
- [11] H. A. Nguyen., S. Giordano., and A. Puiatti, "Probabilistic Routing Protocol for Intermittently Connected Mobile Ad Hoc Network (PROPICMAN)", *World of Wireless, Mobile and Multimedia Networks*, 2007. *WoWMoM* 2007, pp. 1-6, 2007.

## Performance Evaluation of MIMO Receivers in Two-way Decode and Forward Relaying

Mete Yıldırım<sup>1</sup>, Cumhuri Aksu<sup>2</sup>, Selcuk Cankurt<sup>3</sup>

<sup>1</sup>*Gediz University, Izmir, Turkey*

<sup>2&3</sup> *Department of IT, Ishik University, Erbil, KRG-Iraq.*

<sup>1</sup>*meteyildirim2005@gmail.com, <sup>2</sup>cumhur.aksu@ishik.edu.iq, <sup>3</sup>selcuk.cankurt@ishik.edu.iq*

### ABSTRACT

In this paper, error performance analysis of two-way cooperative communication system with decode-and-forward (DF) relaying is examined over frequency selective Rayleigh fading channels. It is considered that all the nodes in the system are equipped with two antennas. Zero forcing, maximum likelihood, minimum mean square estimator receiver are employed at the nodes. As mapping method Binary phase-shift keying (BPSK) is used. The end user node's bit error performance is studied. The system is simulated. The simulation plots are provided. The results show that for BPSK mapping maximum likelihood receiver produces better bit error rate performance.

**Keywords:** Two-way DF relaying, Rayleigh-m fading channels, MIMO, BER performance.

### 1. INTRODUCTION

Digital communication over wireless channels increases every day. Recent works enabled wireless network data transmission speed over Gigabit per second rate. Even though these achievements satisfy majority of users, the wireless communication has some disadvantages too. As an example, if a device is located far away from an ad-hoc hub or there are some obstacles between the wireless devices, the communication can be problematic. Actually, it may not connect the network due to very weak signal reception power. For a possible solution it is considered that any other wireless device between the hub and the destination can help which is a two-way communication (TWC) [1]. When there is no direct connection or signal is very weak, other devices located at midway receive signals, process and forward to the destination. This in-the-middle device is called as relay. When there is not a fixed relay device and each device is also relay to other systems, it becomes a cooperative network. TWC is one type of cooperative relaying. In contemporary TWC, physical layer network coding (PNC) is used [2]. PNC significantly increases the capacity of the transmission by reducing time slots required to exchange information down-to two time slots.

In cooperative two-way relaying, the data processing method at relay device names the type of used protocol. The two general cooperative protocols are; amplify and forward (AF) and decode and forward (DF). AF uses the available channel knowledge to amplify the received signal. The amplified signal is then sent to the destination. In DF, the received signal is first decoded then the decoded bits are mapped into symbols again and retransmitted to the destination [3], [4].

The cooperative system is also known as virtual multi-input multi-output (MIMO). It is well-known fact that when the received signal to noise power is low or the signal is distorted badly due to frequency selective fading, the bit error rate (BER) performance becomes very low. MIMO provides spatial diversity by employing more than one antenna at transceivers [5]. Spatial diversity significantly increases the system BER performance without having extra power or bandwidth cost. MIMO cannot be used in small size devices due to lack of spaces required to locate antennas. Antennas must be spaced such that one can make sure there is no correlation on the received signals at different antennas. Since this space cannot be provided, MIMO is not applicable to the small electronic devices. When there is a chance of using MIMO, the cooperative system can be employed. In CS, the wireless devices let their resources cooperate in order to create a virtual MIMO. Modern systems combine the power of MIMO with virtual MIMO [6], [7]. That is to say that a device can be a part of MIMO as well as a cooperative system.

The different versions of MIMO are; single-input multiple-output (SIMO), multi-input single-output (MISO). SIMO is the same with receiver diversity and MISO is used instead of transmitting diversity. The transmitting diversity is realized with the help of Alamouti code [7]. Signal combining technics employed at the receiver side led the diversity as a rather useful option. Selection combiner, maximum ratio combiner, and equal gain combiner are three well-known combining techniques [8].

The recent studies combine MIMO and CS to employ a different type of receiver. In [9], zero forcing receivers in MIMO two-way system is examined. In [10], MMSE receiver is examined only in MIMO two-way system with three phase communication. There is a need to compare the BER performance of the different type of receivers and to the best of our knowledge, it lacks on comparing zero-forcing, MMSE and ML in MIMO two-way decode and forward with PNC. Hence, in this study, we examined the MIMO-based two-way DF with PNC systems' bit error rate performance for three well-known receiver types [11].

The rest of paper is organized as follows. The next section, introduces a system model in which the receiver models of MIMO and CS protocols are given. Section III discusses simulation results and in the last section the work evaluation is given as conclusion.

## **2. THE SYSTEM MODEL**

We consider three computers as computer one as the Transmitting computer (C1), computer two as the Relaying computer (CR) and computer three as the receiving computer (C3). This can be in reverse order too. Actually, all the computers do receive and transmit but to make it simple to explain we choose it as given. C1 has to communicate C3 through CR. CR receives the signal from C1 and forwards it to C3 by using DF protocol. This is given as in Fig.1. CR is the relaying computer and uses DF protocol. The system model is given as in Fig.2. As seen in the figure, DF will digitize or restore the signal back to original state and if the distortion on the signal is not much, the signal will be completely restored.



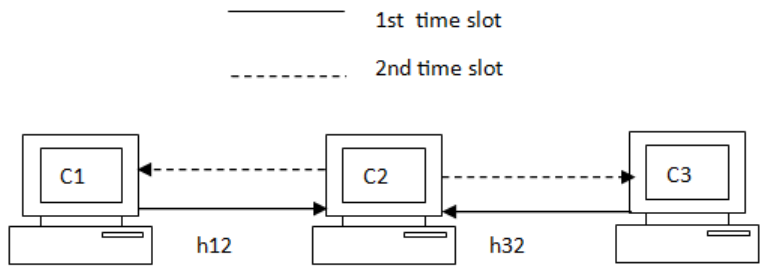

FIGURE 1. The System Model

In the first time slot, C1 and C3 broadcast to CR and in the second time slot CR broadcast back to C1 and C3. C2 separates two signals with PNC. In this example, we consider each computer has a wireless transceiver with two antennas.

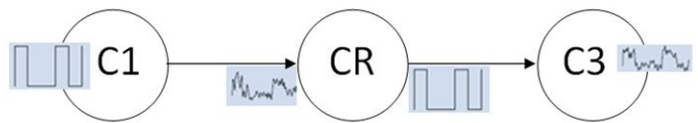

FIGURE 2. DF Protocol

Assuming a photo is to be transmitted, it will be converted to bits and mapped with binary phase shift keying (BPSK). The BPSK symbol vector is given as  $X_n = \{x_1, x_2, \dots, x_n\}$ .

The symbols of message signal  $X_n$  is sent the transmitter antennas at C1 two by two. That means at the first time interval  $x_1, x_2$  and at the second time interval,  $x_3, x_4$ , and so on. Since each computer has two antennas, between any two computers, there are available four channels. This can be shown as in Fig.3 where, for example,  $h_{11}$  means the channel between the first antenna of CR and the first antenna of C1. In the following, all the channels  $h_{ij}$  coefficients (the one causes distortion effect on the signal) have Rayleigh distribution with probability density function of

$$p(z) = \frac{z}{\sigma^2} e^{-\frac{z^2}{2\sigma^2}}, z \geq 0$$

and  $n_{C_{ij}}$  is the independent and identically distributed additive white Gaussian noise with normal distribution.

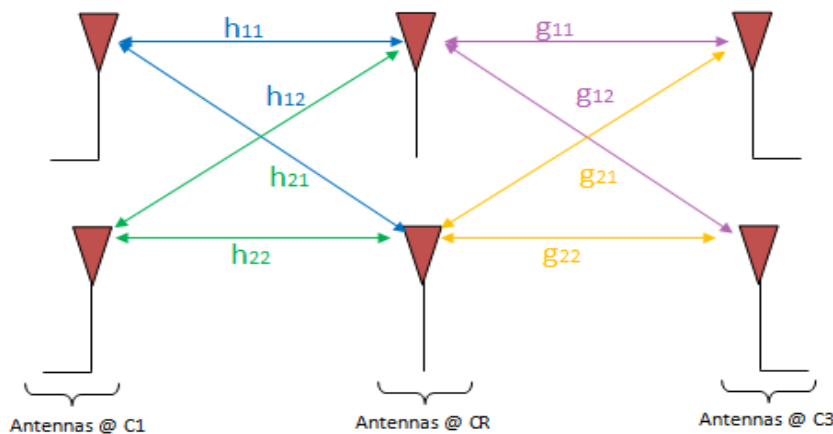

FIGURE 3. Two-way with MIMO with each node having two antennas

The received signal at first antenna of CR from C1 can be written as

$$\gamma_1 = h_{11} \cdot x_1 + h_{12} \cdot x_2 + n_{C1_1} \quad (1)$$

The received signal at second antenna of CR from C1 can be written as

$$\gamma_2 = h_{21} \cdot x_1 + h_{22} \cdot x_2 + n_{C1_2} \quad (2)$$

(1) and (2) can be put in matrix notation as

$$\begin{bmatrix} \gamma_1 \\ \gamma_2 \end{bmatrix} = \begin{bmatrix} h_{11} & h_{12} \\ h_{21} & h_{22} \end{bmatrix} \begin{bmatrix} x_1 \\ x_2 \end{bmatrix} + \begin{bmatrix} n_{C1_1} \\ n_{C1_2} \end{bmatrix} \quad (3)$$

The received signal at first antenna of CR from C3 can be written as

$$\lambda_1 = g_{11} \cdot y_1 + g_{12} \cdot y_2 + n_{C3_1} \quad (4)$$

The received signal at second antenna of CR from C3 can be written as

$$\lambda_2 = g_{21} \cdot y_1 + g_{22} \cdot y_2 + n_{C3_2} \quad (5)$$

(4) and (5) can be put in matrix notation as

$$\begin{bmatrix} \lambda_1 \\ \lambda_2 \end{bmatrix} = \begin{bmatrix} g_{11} & g_{12} \\ g_{21} & g_{22} \end{bmatrix} \begin{bmatrix} y_1 \\ y_2 \end{bmatrix} + \begin{bmatrix} n_{C3_1} \\ n_{C3_2} \end{bmatrix} \quad (6)$$

The signal sum up at antennas of C3 given as

$$\begin{bmatrix} h_{11} & h_{12} \\ h_{21} & h_{22} \end{bmatrix} \begin{bmatrix} x_1 \\ x_2 \end{bmatrix} + \begin{bmatrix} g_{11} & g_{12} \\ g_{21} & g_{22} \end{bmatrix} \begin{bmatrix} y_1 \\ y_2 \end{bmatrix} + \begin{bmatrix} n_1 \\ n_2 \end{bmatrix} \quad (7)$$

The C3 can separate the signals with PNC. Hence, the obtained signals re-encoded and send to the destination. The destination is used to indicate C3 if the sender is C1 or vice versa. The arrived signal from C1 at C3 can be given as

$$\begin{bmatrix} \hat{\lambda}_1 \\ \hat{\lambda}_2 \end{bmatrix} = \begin{bmatrix} g_{11} & g_{12} \\ g_{21} & g_{22} \end{bmatrix} \begin{bmatrix} \hat{y}_1 \\ \hat{y}_2 \end{bmatrix} + \begin{bmatrix} n_{C3_1} \\ n_{C3_2} \end{bmatrix} \quad (8)$$

where we assume the channel  $g_{ij}$  is stable for two time slot and  $\hat{y}_i$  represent the re-encoded symbols sent from C1.

Below three most used receivers models are explained by decoding received signal at the destination.

## A. ZERO FORCING RECEIVER

The receiver at the relaying computer has the data sent from C1 and separated from the one C3 can be given, in short form, as  $\gamma = Hx + n$ . The pseudo inverse of H is given  $W = (H^H H)^{-1} H^H$  where

$$H^H H = \begin{bmatrix} |h_{11}|^2 + |h_{22}|^2 & h_{11}^* h_{12} + h_{21}^* h_{22} \\ h_{12}^* h_{11} + h_{22}^* h_{21} & |h_{12}|^2 + |h_{22}|^2 \end{bmatrix}$$

where the off-diagonals are not zero, hence zero-forcing can experience noise amplification ( $(.)^H$  is hermitian operator).

$$\gamma = (H^H H)^{-1} H^H H x + (H^H H)^{-1} H^H n = I x + \tilde{n} = \tilde{x} \quad (9)$$

In (9),  $\tilde{x}$  is estimated symbol at the relaying computer.  $\tilde{x}$  is sent to the destination terminal. The received symbols at the destination are given as  $\tilde{\gamma} = G \tilde{x} + n$ . The zero forcing receivers is used once again at the destination and the estimated symbols can be given as

$$\tilde{\gamma} = (G^H G)^{-1} G^H G x + (G^H G)^{-1} G^H n = I \tilde{x} + \tilde{n} = \tilde{\tilde{x}}$$

## B. MMSE RECEIVER

The zero-forcing receiver may have poor performance due to noise amplification. This problem is handled in MMSE. Given that  $\gamma = Hx + n$  is the received at relay, MMSE minimize  $E\{[W\gamma - x] \cdot [W\gamma - x]^H\}$  where  $W = [H^H H + N_0 I]^{-1} H^H$  which acts as zero-forcing receiver when the noise is zero.

This gives the estimated symbol  $\tilde{x}$  which is sent to the destination terminal and received again with MMSE receiver, given as  $\tilde{\gamma} = G\tilde{x} + n$ . The MMSE receiver seeks to minimize  $E\{[W\tilde{\gamma} - \tilde{x}] \cdot [W\tilde{\gamma} - \tilde{x}]^H\}$  where  $W = [G^H + N_0 I]^{-1} G^H$  and the estimated symbols  $\tilde{\tilde{x}}$  is found.

## C. ML RECEIVER

The maximum likelihood receiver looks for  $\bar{x}$ , to minimize  $\epsilon = |\gamma - H\bar{x}|$ . Since the BPSK is used, there are four possible options for  $\bar{x}$  which are  $[(1,1), (-1, -1), (1, -1), (-1,1)]$ . The  $\epsilon$  for all values of  $\bar{x}$  is given as

$$\epsilon_{X_i, X_j} = \left| \begin{bmatrix} \gamma_1 \\ \gamma_2 \end{bmatrix} - \begin{bmatrix} h_{11} & h_{12} \\ h_{21} & h_{22} \end{bmatrix} \begin{bmatrix} X_i \\ X_j \end{bmatrix} \right|^2$$

The estimated transmit symbols are chosen based on  $\min(\epsilon_{i,j})$  which is, for example, if the minimum is  $\epsilon_{1,1}$ , then the symbols  $[1, 1]$  are transmitted.

The estimated symbols retransmitted again to the destination and received with ML as explained above.

## 3. SIMULATION RESULTS

In Fig.4, bit error rate performance of the proposed system for three receivers is given at relay station. There is also provided analytic results SIMO and SISO systems for comparison. It is seen that zero forcing performs like SISO which can be considered low performance taking into account that two antennas are located at the receiver. When we apply MMSE receiver instead of zero forcing, the performance

increases. The best results are offered by ML receiver. For example, the ML receiver shows 20 times better performance at 10dB.

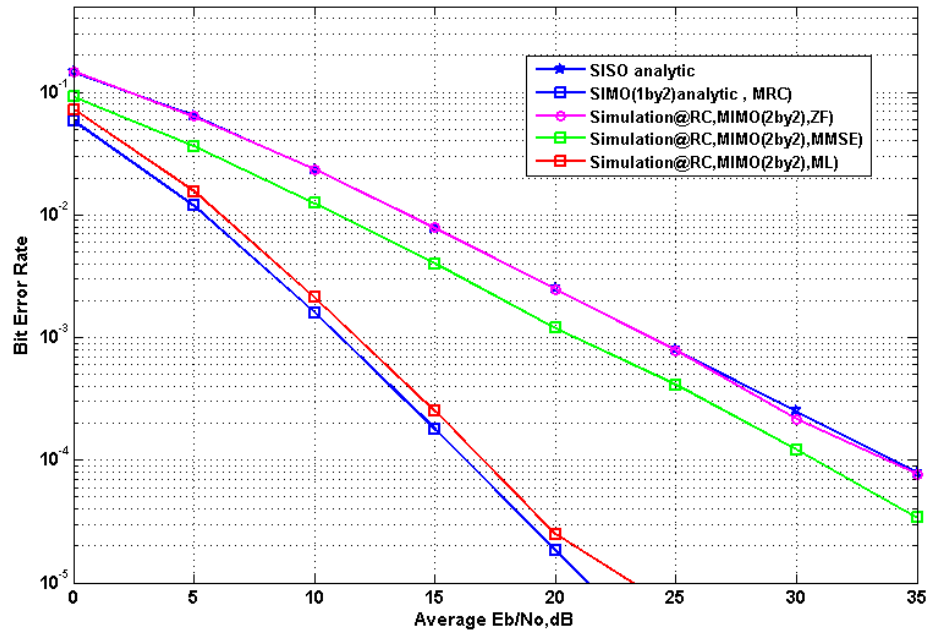

FIGURE 4. Three receiver's performance at the Relay

In Fig.5 bit error rate performance of the proposed system is given at destination station. The performance degrades for all receivers at D. The ML performance at 20dB is  $10^{-4}$  meaning that one-bit error in ten thousand bit which is in acceptable level.

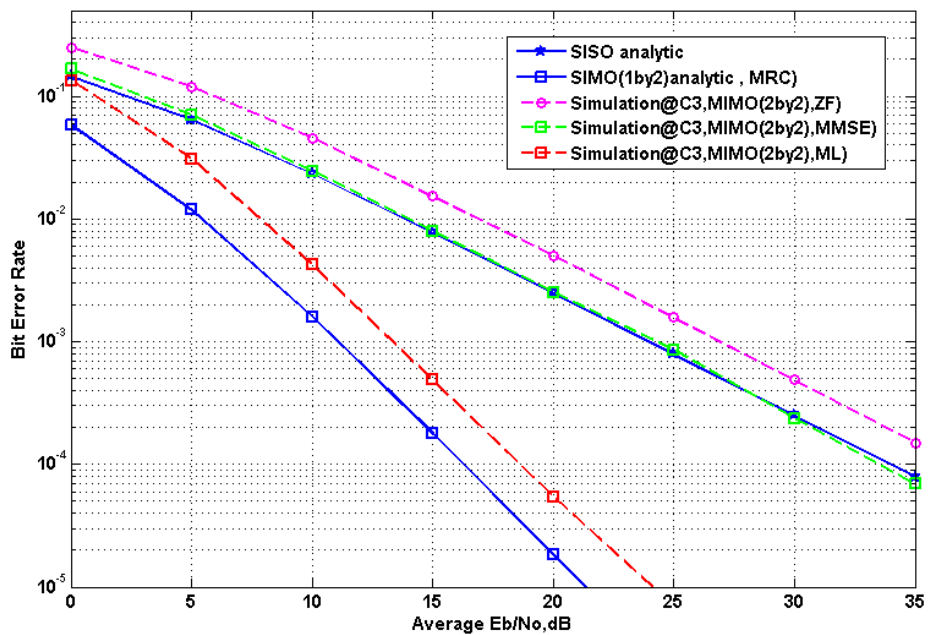

FIGURE 5. Three receiver's performance at the Destination

The last figure shows the performance of relay and destination node together for giving perspective in performance degrading from relay station to destination station. In the figure, it is clearly seen that ML in MIMO with 2 by 2 antennas can achieve the SISO direct transmission.

#### 4. CONCLUSIONS

Two-way communication system with MIMO is implemented over Rayleigh fading channels where we have assumed each node has two antennas.

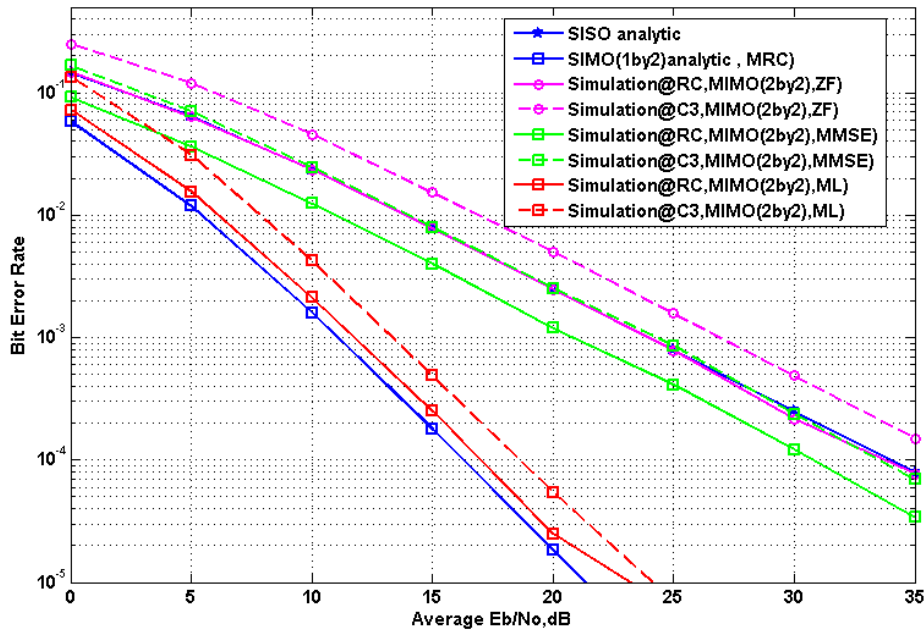

FIGURE 6. Three receiver's performance at the Relay and Destination

By employing MIMO, first of all the data transmission speed is doubled since two antennas send two different symbols for a given time. Considering the ML performance at the destination, it is seen the last station will have the bit error rate as low as a relay station of SIMO system with the diversity order of two. This shows that by employing MIMO, two-way communication can offer a healthy communication for a node which cannot receive service directly.

## REFERENCES

- [1] Y. Li, R. H. Louie, and B. Vucetic, "Relay selection with network coding in two-way relay channels," *Vehicular Technology, IEEE Transactions on*, vol. 59, no. 9, pp. 4489–4499, 2010.
- [2] Zhang, Shengli, Soung Chang Liew, and Patrick P. Lam. "Hot topic: physical-layer network coding." *Proceedings of the 12th annual international conference on Mobile computing and networking*. ACM, 2006.
- [3] A. Nosratinia, T. E. Hunter, and A. Hedayat, "Cooperative communication in wireless networks," *Communications Magazine, IEEE*, vol. 42, no. 10, pp. 74–80, 2004.
- [4] J. N. Laneman, D. N. Tse, and G. W. Wornell, "Cooperative diversity in wireless networks: Efficient protocols and outage behavior," *Information Theory, IEEE Transactions on*, vol. 50, no. 12, pp. 3062–3080, 2004.
- [5] E. Telatar, "Capacity of multi-antenna gaussian channels," AT&T Bell Labs, Tech. Rep, 1995.
- [6] Yu, Yuehua, et al. "Computationally efficient relay-source antenna selection for MIMO two-way relay networks." *Communications (ICC), 2015 IEEE International Conference on*. IEEE, 2015.
- [7] Wang, Rui, and Meixia Tao. "Joint source and relay precoding design for MIMO two-way relaying based on MSE criterion." *Signal Processing, IEEE Transactions on* 60.3 (2012): 1352-1365.
- [8] Alamouti, Siavash M. "A simple transmit diversity technique for wireless communications." *Selected Areas in Communications, IEEE Journal on* 16.8 (1998): 1451-1458.
- [9] Gao, Hui, et al. "Zero-forcing based MIMO two-way relay with relay antenna selection: Transmission scheme and diversity analysis." *Wireless Communications, IEEE Transactions on* 11.12 (2012): 4426-4437.
- [10] Li, Gen, Ying Wang, and Ping Zhang. "Linear MMSE processing design for 3-phase two-way cooperative MIMO relay systems." *Signal Processing Letters, IEEE* 19.7 (2012): 443-446.
- [11] A. Goldsmith, *Wireless communications*. Cambridge, 2005.

## **Mechanical Performance of Concrete Reinforced with Steel Fibres Extracted from Post-Consumer Tyres**

Khaleel H. Younis

*Lecturer at Erbil Polytechnic University (EPU), Erbil, KRG-Iraq  
khaleelyounis@epu.edu.krd*

### **ABSTRACT**

The utilization of recycled materials in the production of concrete could enhance sustainability of concrete. This study aims at examining the influence of using recycled steel fibres (RSF) derived from post-consumer tyres on the mechanical performance of concrete. The examined properties included compressive strength, splitting tensile strength and flexural strength of concrete. Seven mixes: one plain, three with industrial steel fibres (ISF) and three with RSF were investigated. The results show that RSF can improve the mechanical performance of concrete. Mixes with RSF can exhibit comparable performance to that of ISF at the same fibre content or better performance when the fibre content is higher than that of ISF. The strength increase in the case of flexural and splitting tensile was higher than that of compressive strength.

**Keywords:** Concrete, Mechanical properties, Industrial fibre, Recycled steel fibre.

### **1. INTRODUCTION**

The increasing generation of massive quantities of waste materials is becoming a global sustainability and environmental issue the world is currently facing. The disposal of this waste leads to serious environmental concerns such as consumption of limited landfills area [1]. An example is the disposal of the post-consumer tyres. According to European Tyre Recycling Association [2], 300 million of post-consumer tyres are discarded each year in the European Union alone. Nonetheless, the impact of such environmental problems can be mitigated through the utilization of waste materials in the production of concrete.

The utilization of recycled steel fibres (RSF) derived from post-consumer tyres in new constructions could enhance sustainability of concrete. This enhancement of concrete sustainability can be achieved through eliminating consumption of limited landfill areas and reducing energy consumption which in turn diminish the damage to the environment.

It is well known that plain concrete is characterized by low tensile strength [3]. This has led to the use of reinforcing bars to enhance the structural performance of concrete. In some applications, in order to increase the mechanical performance of concrete and also for more cost-effective and less time of construction, fibre reinforced concrete (FRC) was developed [3], [4]. Replacing rebars by fibres in reinforcing concrete reduces the cost and time of placing of the steel bars as well as decreases the depth of the section of concrete elements. In addition, fibres may enhance post-cracking (toughness) behavior, shrinkage, fatigue and impact resistance behaviour of plain concrete [3], [4]. Due to their high stiffness, randomly distributed steel fibres have been reported to improve the mechanical properties of

concrete. Because of the random distribution of fibres in concrete, larger volumes (than rebar) are required in order to obtain the same performance as conventional reinforced concrete [3]. Thus, this in some cases leads to that the use of fibres, particularly industrial steel fibres (ISF), becomes uneconomical. Therefore, RSF recovered from post-consumer tyres have been put forward as a cheaper alternative to ISF.

Many studies have been conducted on the effect of ISF on the mechanical properties of concrete [4-7]. However, few studies [8-10] can be found on the mechanical behavior of concrete with RSF. The first investigations on the mechanical properties of concrete mixes incorporating RSF derived from waste tyres were started at the University of Sheffield in early 2000 [9].

The studies on the behavior of concrete with ISF reveal that the strength improvement due to adding ISF is not the same among compression, splitting tensile and flexural strength [11]. The presence of steel fibre (up to certain content) causes marginal increase in compressive strength. The observed strength increases are ranging from (6 - 15%). For tensile strength, higher strength improvement (20-40)% were reported [11]. Significant strength enhancement achieved in the case of flexural strength of concrete with up to 50 % strength increase [5], [11].

This study is part of a research which examines the effect of utilizing RSF extracted from post-consumer tyres on the mechanical properties (compressive, splitting tensile and flexural strength), the post cracking behavior and shrinkage of concrete. In this paper, only the results of the mechanical behavior are presented and discussed. For comparison purposes the study includes mixes with ISF.

## 2. MATERIALS AND EXPERIMENTAL PROGRAMME

### 2.1 MATERIALS

- **CEMENT**

The type of cement used throughout this study was Portland Cement CEM I, meeting the requirements of BS EN 197 [12]. The chemical analysis of the cement (as given by the supplier) is shown in Table 1.

TABLE 1. Chemical analysis of OPC

SiO <sub>2</sub>	Al <sub>2</sub> O <sub>3</sub>	Fe <sub>2</sub> O <sub>3</sub>	CaO	MgO	SO <sub>3</sub>	Na <sub>2</sub> O	K <sub>2</sub> O	Na <sub>2</sub> O <sub>eq</sub>
20.96	4.97	2.86	65.9	0.78	2.8	0.24	0.43	0.52

- **AGGREGATES**

The fine aggregate used in this study was sand with a maximum size of 5 mm. The coarse aggregate was rounded fully water-worn river aggregate with maximum size of 20 mm.



- **FIBRES**

Two types of steel fibres were used in this study, one type of recycled and one type of industrially produced steel fibres. The properties of both types are described herein.

Industrial steel fibres (ISF) from a cold-drawn process were used and they had a deformed shape as shown in Figure 1. The fibre length was 30 mm and the diameter was 0.5 mm. The fibres had nominal tensile strength of 1100 MPa.

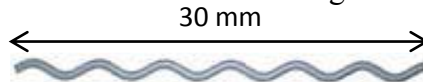

FIGURE 1. Industrial steel fibres (ISF)

The RSF utilized in this study were obtained by post-processing tyre wire derived from the mechanical processing of post-consumer tyres [13]. Recycled steel fibres with a diameter around 0.2 mm (see Figure 2a) and a tensile strength of around 2000 MPa were used in this study. The recycled steel fibres had variable lengths ranging from 3-28 mm (5% of the fibres had length shorter than 3 mm and 5% longer than 28 mm). The distribution of the length of RSF as determined using a specially developed image analysis technique is shown in Figure 2b. This technique was first developed by The University of Sheffield in the UK [14]. The sample utilized to obtain the length distribution contained more than 1150 fibres.

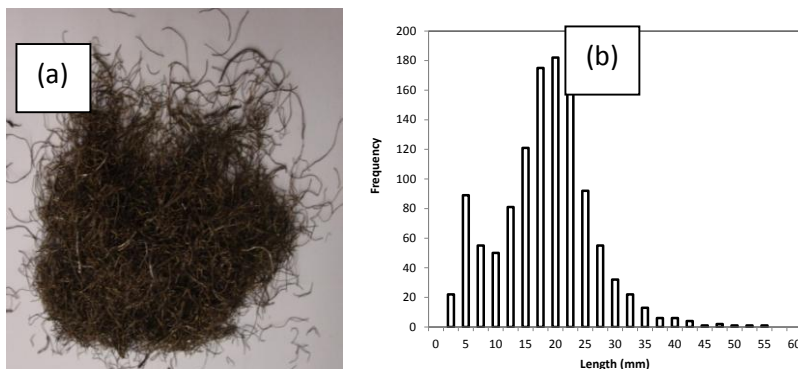

FIGURE 2. a- Recycled steel fibres (RSF) b- Length distribution of recycled steel fibres.

- **SUPERPLASTISIZERS**

Superplasticizers were used to achieve concrete with acceptable workability which was assessed using slump test. The superplasticizer used in this study was an aqueous solution containing polycarboxylate ether (PCE) polymers.

## 2.2 MIX PROPORTIONS, VARIABLES AND SPECIMENS PREPARATION

Seven different mixes were prepared. The code of mixes and the variables of the study are shown in Table 2. All mixes prepared with the same water/cement (w/c) ratio (0.45). The mixes can be divided into two groups according to the type of steel fibres used in the concrete mix (three mixes contain ISF and the other three mixes contain RSF) and a reference mix which was plain concrete. Fibres were added with

different contents as can be seen in Table 2. All mixes had the same quantity of cement ( $350 \text{ kg/m}^3$ ), water ( $157.5 \text{ kg/m}^3$ ) and fine aggregate ( $565 \text{ kg/m}^3$ ), whilst the quantity of coarse aggregate used was  $1270 \text{ kg/m}^3$ . Superplasticizers were added to all mixes with a content of 0.3 % of cement mass to achieve workability of 60-100 mm slump.

TABLE 2. Code of mixes, variables of study

Mix no.	Mix code	Fibre type	Fibre content % <sup>a</sup>	Fibre mass (kg/ m <sup>3</sup> of concrete)
1	M1	-	0	0
2	M2	Industrial	2	48
3	M3	Industrial	4	96
4	M4	Industrial	6	144
5	M5	Recycled	2	48
6	M6	Recycled	4	96
7	M7	Recycled	6	144

<sup>a</sup> By concrete mass.

For each mix: three (100 mm) cubes, three cylinders (100×200 mm) and three prisms 100×100×500 mm, were cast. The concrete was mixed using a pan mixer and compacted using a vibrating table. After casting, the specimens were then covered by plastic sheets and allowed to cure for 24 hours before being demoulded. Then, the specimens were kept in water tanks for 27 days for further curing.

## 2.3 TESTS

- **COMPRESSIVE STRENGTH TEST.**

The compressive strength was obtained at age of 28 days using the (100 mm cubes) and BS EN 12390-3 [15].

- **SPLITTING TENSILE STRENGTH TEST.**

The splitting tensile strength was obtained at age of 28 days using the (100×200 mm cylinders) and BS EN 12390-6 [16].

- **FLEXURAL STRENGTH TEST.**

The flexural strength was obtained at 28 days using the (100×100 ×500) mm prisms). All prisms were tested in four-point loading over a length of 300 mm following the recommendations of the BS EN 12390-5 [17].

## 3. RESULTS AND DISCUSSION

### 3.1 COMPRESSIVE STRENGTH

Table 3 present the results of the 28 days compressive, splitting tensile and flexural strength for all mixes. The result of each mix is the average of 3 specimens. The table also shows the normalized strength (to that of the plain concrete, mix M1) and the standard deviation (SD) of all results. Fig. 3a shows the normalized compressive strength of all mixes.

TABLE 3. Results of compressive, splitting tensile and flexural strength with the standard deviation (SD)

Mix	Compressive strength		Splitting tensile strength		Flexural strength	
	Strength in MPa (SD)	Normalized Strength	Strength in MPa (SD)	Normalized Strength	Strength in MPa (SD)	Normalized Strength
M1	45.3 (0.4)	1.00	3.6 (0.1)	1.00	4.2 (0.2)	1.00
M2	50.1 (1.0)	1.10	4.4 (0.2)	1.22	4.8 (0.2)	1.12
M3	48.6 (1.1)	1.07	4.7 (0.4)	1.29	5.1 (0.5)	1.21
M4	46.1 (2.1)	1.02	4.7 (0.1)	1.31	4.9 (0.1)	1.16
M5	47.6 (1.8)	1.05	4.2 (0.4)	1.17	4.6 (0.3)	1.09
M6	50.4 (1.6)	1.11	4.6 (0.1)	1.27	5.0 (0.1)	1.18
M7	47.2 (1.8)	1.04	4.6 (0.2)	1.26	4.8 (0.2)	1.14

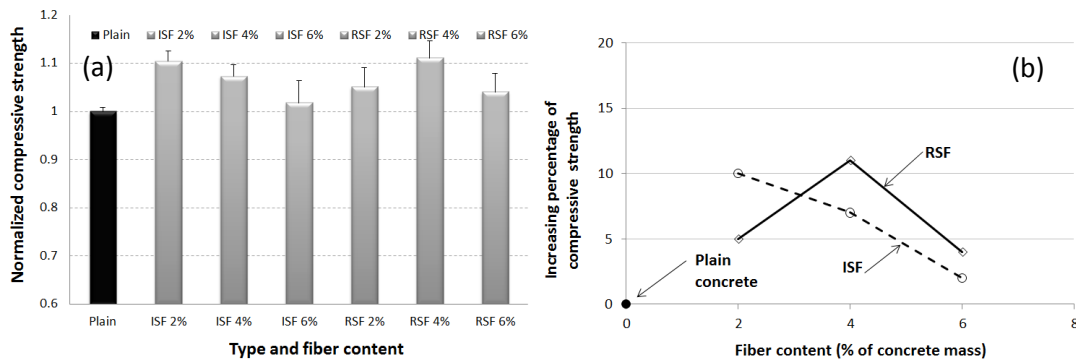

FIGURE 3. a-Normalized compressive strength of all mixes b- Effect of fiber content on the increase of compressive strength.

Table 3 and Fig. 3a show that the addition of fibres resulted in a margin increase (2%-11%) in the compressive strength regardless the type of fibres. The addition of 2%, 4% and 6% of ISF to the concrete led to a strength improvement of 10%, 7% and 2% respectively, in comparison to the plain concrete. Almost similar strength enhancement was achieved with the mixes incorporating RSF (5%, 11% and 4% for 2%, 4% and 6% content of RSF, respectively). It can be seen that the Mix 6 which includes 4% RSF exhibits similar strength increase to that of Mix 2 which includes

2% ISF. It seems that the RSF can show comparable performance to that of ISF by increasing the content of fibre.

Fig. 3b shows the effect of fibre content on the percentage of compressive strength increase (in comparison to the plain concrete) of both ISF and RSF mixes. For the mixes with ISF, a trend can be seen as with increasing the fibre content, the strength improvement decreases. This can be attributed to the effect of increased porosity of the fibre reinforced concrete mixes. During mixing and compaction, fibres may entrap large air voids especially with high content of fibres [18]. This increase in the content of air voids can lead to lower strength enhancement. For mixes with RSF, it seems that the addition of fibre is beneficial up to certain fibre content (4%) after that the increase in strength starts to decrease and this could be due to the same effect of entrapped air voids.

### 3.2 SPLITTING TENSILE STRENGTH

The results of the splitting tensile strength for all mixes are presented in Table 3. Regardless of the type of fibres, the strength increase in the case of splitting tensile is higher than the compressive strength. This is expected as it is known that fibre can delay the development and the propagation of tensile induced cracks [11]. For the mixes with ISF, increasing the addition of fibre from 2% to 4% led to a strength enhancement of 7%, whereas a further 2% increase of fibre content (from 4% to 6%) showed only 2% strength improvement as can be seen in Fig. 4 which shows the effect of fibre content on the percentage increase in splitting tensile strength. This may be attributed to the effect of high air voids content mentioned above due to the high content of fibres. The mixes reinforced with RSF shows comparable behavior to those reinforced with ISF up to 4% fibre content. However, for 6% fiber content, the tensile strength decreases slightly. This could be because that RSF are shorter than the ISF which means higher number of fiber for the same content of fibers which in turn may lead to a higher entrapped air voids ratio causing reduction in the strength.

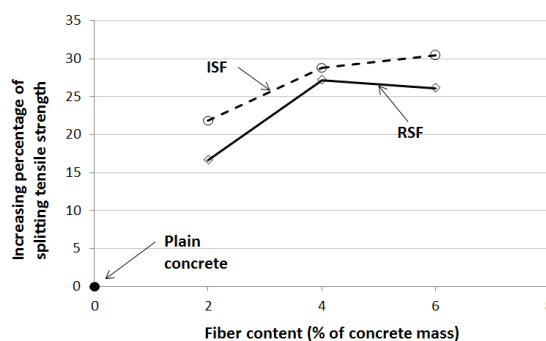

FIGURE 4. Effect of fiber content on the increase in splitting tensile strength

### 3.3 FLEXURAL STRENGTH

The results of the flexural strength are shown in Table 3. Similar to that of splitting strength, the increase in flexural strength of the mixes with fibres is higher than the increase in compressive strength. This may be due to the effectiveness of fibres in delaying the development of micro-cracks. Mixes incorporating ISF showed

strength increase up to 21% at 4% fiber content. Mixes made with RSF exhibited strength improvement up to 18% at 4% fiber content. Hence, RSF can demonstrate comparable behavior to that of ISF at same fiber content or better behavior with increasing the fiber content.

Fig. 5 shows the effect of fibre content on the percentage increase in flexural strength. It can be seen that, regardless of the type of fibre, the addition of fibres is beneficial up to certain content (4%) after that the increase in strength starts to decrease yet still higher than the plain concrete. This may be attributed to the effect of high air voids content mention above due to the high content of fibres.

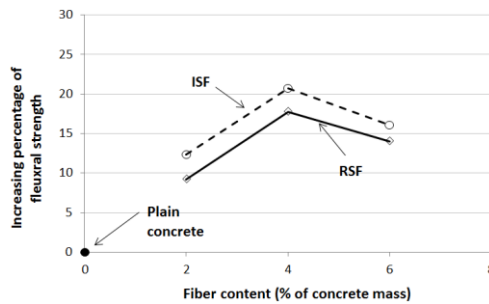

FIGURE 5. Effect of fiber content on the increase in flexural strength

#### 4. CONCLUSIONS

This study examined the effect of utilizing recycled steel fibre derived from post-consumer tyres on the mechanical behavior (compressive, splitting tensile and flexural strength) of fiber reinforced concrete. The following conclusions can be drawn based on the results and discussion:

1. The addition of fibres can increase the compressive strength of concrete. However, the strength enhancement is less than that achieved in splitting tensile and flexural strength. High contents of fibres show lower strength improvement than low fiber. This can be attributed to the effect of increased air voids ratio.
2. Higher strength increase was observed in the case of splitting strength. At 4% fibre content, strength improvements up to 29% (for the mix with ISF) and 27% (for the mix with RSF) were obtained.
3. The addition of RSF can increase the flexural strength of concrete up to 18% at 4% fibre content showing comparable strength enhancement to that of mixes with ISF at the same fiber content and higher than that of mix with 2% ISF.
4. RSF can demonstrate comparable behavior to that of ISF at same fiber content or better behavior with increasing the fiber content.
5. Further research is recommended to examine the effect of air voids content on the mechanical behavior of concrete with RSF.

#### REFERENCES

- [1] Younis, K. H. and K. Pilakoutas, Strength prediction model and methods for improving recycled aggregate concrete. *Construction and Building Materials*, Vol. 49, No. 0, pp. 688-701, 2013.

- [2] European Tyre Recycling Association (ETRA),. Introduction to Tyre Recycling:2010. Paris, France, 2010.
- [3] Concrete Society TR 34, Concrete Industrial Ground Floors - A Guide to their Design and Construction.3<sup>rd</sup> ed., London , 2003.
- [4] Tlemat, H., Steel fibres from waste tyres to concrete: testing, modelling and design. PhD.thesis, The University of Sheffield, UK, 2004.
- [5] Khaloo, Ali R., and Majid Afshari. "Flexural behaviour of small steel fibre reinforced concrete slabs." *Cement and Concrete Composites*, vol. 27.1, p 141-149, 2005.
- [6] Altun, Fatih, Tefaruk Haktanir, and Kamura Ari. "Effects of steel fiber addition on mechanical properties of concrete and RC beams." *Construction and Building Materials*, vol. 21, 3 ,p. 654-661, 2007.
- [7] Boulekbache, B., Hamrat, M., Chemrouk, M. and Amziane, S., Flowability of fibre-reinforced concrete and its effect on the mechanical properties of the material. *Construction and Building Materials*, vol. 24(9), pp. 1664-1671, 2010.
- [8] Pilakoutas, K., K., Neocleous, Tlemat, H., Reuse of steel fibres as concrete reinforcement. *Engineering Sustainability*, Vol. 157, No. ES3, pp. 131-138, (2004)
- [9] Pilakoutas, K. and R. Strube, Re-use of Tyres fibres in concrete. *Proceedings of the International Symposium on Recycling and Reuse of Used Tyres*, Thomas Telford, University of Dundee, Dundee, UK, 2001.
- [10] Graeff, A., Long-term performance of recycled steel fibre reinforced concrete for pavement application. PhD. dissertaion, The University of Sheffield, Sheffield,UK, 2011.
- [11] ACI Committee 544.1R, Fiber reinforces concrete, American concrete institute, Michigan, USA, 1996.
- [12] BS EN 197-1, Cement: Composition, specifications and conformity criteria for common cements. British Standard Institution, London, UK, 2011.
- [13] Musacchi, E., P. Iacobucci, Potential process for cleaning and sorting of the recycled fibres, Deliverable report 13, FB6 STREP Project Ecolanes (031530). Deliverable report 13, 2008.
- [14] Neocleous. K., Angelakopoulos, H., Pilakoutas, K. and Guadagnini, M., Fiber reinforced roller-compacted concrete transport pavement, in *proceedings of the ICE- Transport vol 164(2)*, p. 79-109, 2011.
- [15] BS EN 12390-3, Testing hardened concrete Part 3: Compressive strength of test specimens. British Standard Institution, London, UK, 2009.
- [16] BS EN 12390-6, Testing hardened concrete Part 6: Splitting tensile strength of test specimens. British Standard Institution, London, UK, 2000.
- [17] BS EN 12390-5:2009, Testing hardened concrete Part 5: Flexural strength of test specimens. British Standard Institution, London, UK, 2009.
- [18] Hannant, P. J. *Fibre cements and fibre concretes*. No. Monograph. 1978.

## **A Two Dimensional GIS Model for Highway Alignment Corridor Search**

Botan M AL-Hadad<sup>1</sup>, Mohammed D Allaf<sup>2</sup>, Glpa A Mahmood<sup>3</sup>, Wrya H Nadir<sup>4</sup>

<sup>1,2,3&4</sup> *Erbil Technology Institute, Erbil Polytechnic University (EPU), Erbil, KRG-Iraq*

<sup>1</sup>*botan@epu.edu.krd*, <sup>2</sup>*mohammed.dler@gmail.com*, <sup>3</sup>*galaligilpa@yahoo.com*,

<sup>4</sup>*wrya.hade@yahoo.com*

### **ABSTRACT**

Highway alignment development is a complex, iterative, and time-consuming process. In an area where an alignment is built thousands of alternatives need to be searched so that the final result is optimum. This study uses Geographic Information System (GIS) capabilities as an assistant tool to search for a corridor where the best possible highway alignment can be found. The study aims to narrow down search spaces for highway alignment development into a corridor based user/planner/designer defined width using GIS. A GIS model, considering the construction and land use costs as an objective function, was built and successfully located a path between two fixed termini points. The results were validated using a Genetic Algorithm (GA) model, which was previously developed by AL-Hadad (2011)[1], and the path results were promising as potential corridor search space centerlines. Narrowing down search spaces from the whole study area to a specific corridor reduces the time required to locate global optimum alignment solutions. Further investigations are required to generate highway alignments within the corridor in such a way that the optimality of the solutions is enhanced efficiently.

**Keywords:** GIS, GA, Highway Corridor, Optimization.

### **1. INTRODUCTION**

Highway alignment optimization aims to connect two terminal points at minimum possible cost subject to a number of design constraints. The traditional approach for highway alignment development results in a local optimum solution. The approach is manual and is able to assign only a handful number of candidates with which the final result is local optima. Trying to consider the study area for a countless number of candidates is a very expensive process and time consuming.

Researchers have tried to represent search spaces into mathematical and computerized model. Different algorithms were used to locate best alignment alternatives exploiting and utilizing the overall study area. Despite the time, as shown in these studies, searching in a very wide area results in overburdening the process and may not be able to locate the global solution.

Researchers have also tried to benefit from GIS as a repository for geographical and spatial data. Road researchers used GIS to represent areas where the proposed road project is located. The study area is then represented and integrated with optimization models.

This research study uses GIS as an assistant tool for optimum highway alignment corridor determination. A mathematical model has been built using GIS so that a two dimensional study area, based on a customized objective function, is searched. The model searches the area until the least cost centerline path is specified. A buffer is

then defined on both, right and left, hand sides of the centerline path forming a search corridor. The width of the buffer may depend on the user/planner's preferences. The buffered area is then considered as a corridor where the potential/proposed global optimum highway alignment solution is found.

### **1.1 THE CONVENTIONAL APPROACH**

In conventional highway design projects, highway engineers and planners select several candidates as alternative solutions and evaluate their suitability for the region's environment until coming up with the most suitable one [2].

Using the conventional approach only a number of candidate alignments are generated where thousands are possible to exist. These alignments, in an iterative process, undergo evaluation through which the best alignment is determined. Therefore, the process is considered very expensive in terms of time.

Attempts have been made by researchers trying to computerize the process described by the conventional approach. Calculus of variations [3], numerical analysis [4], linear programming [5], and genetic algorithms [6, 7, 8] are some of the techniques that have been used. [9, 10, 11] have incorporated GIS just to digitally represent the area and to make the spatial information/data handy.

It was noted that the GIS based researches added no novelty to the quality of the final result and the speed of the process. GIS was exploited to make the area digital for integration with the mathematical models only.

The question is to what extent the search space between two termini points can be reduced with which thousands of worthless candidates are eliminated? This study, through the GIS capabilities, tries to define a zone/corridor within which the best alignment candidate is searched. It is expected that the time required for search is considerably reduced and the quality of the final solution is enhanced. It is also expected that the process avoid being stuck at local optima and avoids search misleading especially where the study area is very wide with numerous entities and complex configurations. GIS as a new technology may add beneficial inputs for the planners in highway alignment development.

### **1.2 THE NEW APPROACH WITH GIS**

This study suggests the use of GIS for establishing a search corridor where best highway alignment can be found. Narrowing down the study area reduces the time required to search in areas where no best solution is available. Thus, the wasted search time is eliminated.

The GIS path results is validated using Genetic Algorithms (GA). GA is an efficient evolutionary adaptive search technique [6, 7, 8, 12, 13, 14, 15] used to perform searches in relatively complex areas. The GA search is done using a model that was previously developed by AL-Hadad (2011) [1]. The results of GIS and GA models are then compared.

## **2. THE GIS MODEL FORMULATION**

### **2.1 THE STUDY BOUNDARY**

Several 2D study areas (worlds) have been extracted from GIS from very simple to complex ones. The simple areas with already known solutions were used for



visual inspection of the results and to make sure that the GIS model and the formulation is valid. For each world, features and land uses are represented through rectangular grid cells (pixels). The size of the grid cells falls within the user preferences and depends on the desired accuracy. Each grid cell may handle one or more than one average value (data).

World sizes of 4000mx8000m with grid cell sizes 200mx200m are defined for this research study. The average cost of the land use for highway alignment land acquisition and construction is calculated and attached to each cell. For each world and test, the termini points are considered known and fixed prior to the test runs.

Figure 1 shows the GIS model case study area. The area has different land uses with different cost values.

## 2.2 THE GIS COST MODEL

A GIS model is developed to search for a path that incurs least cost. The model relies on a cost function that considers land use and path length costs. This function leads the GIS model to move from a grid cell/pixel center to another. Thus, a piecewise linear trajectory lines are formed from successive interconnected cells between the two termini points representing the desired path. The goodness of the path is evaluated in terms of the assigned costs. Different cost values may be used for better representation of the study.

## 3. THE GA MODEL FORMULATION

### 3.1 THE STUDY BOUNDARY (SEARCH AREA)

The study area produced from the GIS is re-produced in the GA model with the same land use configuration and cost values. Figure 2 is the study area from the GA model.

### 3.2 THE GA OPERATORS

A GA model that was previously produced by the author [1] is used to search for a path in the defined area. The use of the model has two objectives. First, to verify the validity of both the GIS and GA models. Second, is to study the possibility of integrating both models in one. Details of the GA model are found in [1].

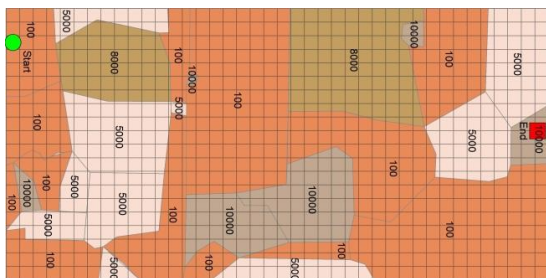

FIGURE 1. Study area format with grid cells from GIS model

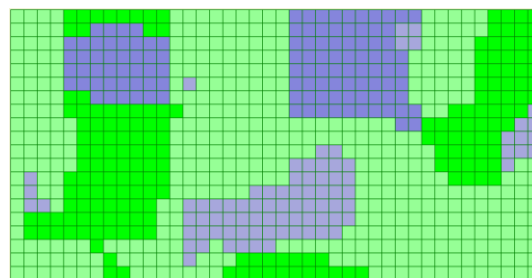

FIGURE 2. The study area re-produced from GA model

### 3.2.1 CHROMOSOME REPRESENTATION

A previous research study [1] defines alignment through station points along the centerline of the path. The X and Y coordinate of the points used as decision variables representing the centerline along the path.

In genetic algorithms, a chromosome (also sometimes called a genotype) is a set of parameters which define a proposed solution to the problem that the genetic algorithm is trying to solve. The set of all solutions is known as the population [16].

The candidate solutions are represented in chromosomes as in Figure 3. The station points appear in the order in which they occur along the length of the path.

Individual (j)	X <sub>0</sub>	X <sub>1</sub>	X <sub>2</sub>		X <sub>i</sub>				X <sub>n</sub>
	Y <sub>0</sub>	Y <sub>1</sub>	Y <sub>2</sub>		Y <sub>i</sub>				Y <sub>n</sub>

FIGURE 3. Solution/Chromosome representation

### 3.2.2 INITIAL POPULATION AND REPRODUCTION

An initial population of random individuals is generated such that all station points are within the study area and the genes (X and Y) are encoded using floating numbers. The termini points are assumed known.

The reproduction process selects the individual based on their fitness (ranking based selection). The selected parents undergo multiple point crossover to swap a number of genes (segments) of the individuals to produce two new offspring [17].

Modified uniform mutation (MUM) based on that described by [18] is used. It is designed to link a number of selected station points with a single mutated one. This operator selects a gene position ( $p$ ) randomly and assigns a new random value for its X and Y coordinates. Then the operator generates two more locations ( $l_1$  and  $l_2$ ) provided that  $l_1 < p < l_2$ . Then, all the genes (station points) that locate between  $l_1$  and  $p$ , and  $l_2$  and  $p$  on the other side are reallocated and put on a straight line connecting the newly generated gene at  $p$  with the selected genes at  $l_1$  and  $l_2$ .

### 3.3 THE FITNESS FUNCTION

Fitness function is a function through which the suitability of the solution with regard to the defined environment of the study area is evaluated.

In this study, the fitness function is formulated so that it incurs the same cost on the resulted path as the GIS cost model does. The construction cost of the path is linked with locations (land use) where the path passes through. The aim of the process is therefore to minimize;

$$C_{Total} = Cost_{Location} + Cost_{Construction} \quad (1)$$

The total cost is calculated:

$$C_{total} = \sum_{k=1}^p l_k \times UC_{Cell}C \quad (2)$$

Where:  $C_{total}$  is the total path cost;  $l_k$  is the length of the path located in grid cell  $k$  with a specific cost value;  $UCellC$  is the unit cell cost of that cell; and  $p$  is the total number of cells that the path passes through. Thus,  $(\sum_{k=1}^{k=p} l_k = L)$ .  $L$  is the total length of the path, and  $n$  is the total number of the points along the path (the points represents and configures the path).

The length of the path is calculated using the X and Y coordinates of the successive predetermined station points along the path as:

$$L = \sum_{i=0}^{n-1} \sqrt{(X_{i+1} - X_i)^2 + (Y_{i+1} - Y_i)^2} \quad (3)$$

for all  $i = 0, 1, 2 \dots (n-1)$

#### 4. EXPERIMENTAL RESULTS

##### 4.1 THE GIS MODEL TEST RESULTS

The results from the GIS model are as depicted in Figures 4, 5, and 6. The results connect the two termini points through the least cost lands. As shown, the paths are the shortest and avoids the high cost lands. The results depict a centerline for a possible corridor.

Figure 4 represents a land use with uniform cost configuration and the result is straight, as expected, between the two termini. Figure 5 represents a uniform land configuration having a cost barrier land at the middle. The path, as shown, is winding around the high cost area so that the path cost result is minimal. These two test scenarios were used for the verification of the GIS model formulation.

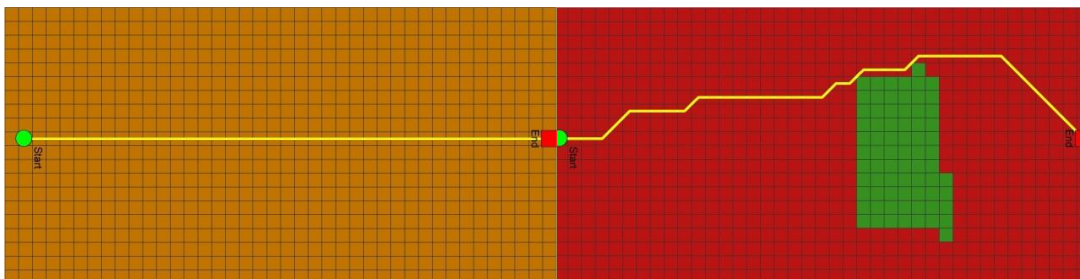

FIGURE 4. A study area with uniform cost land use

FIGURE 5. A study area with a high cost land at the middle

Figure 6 represents a result of the case study where different land use configurations are represented. The path result avoids the high cost lands. The length of the path is 12,525.48m with a cost amounting 4,222,548 unit cost. It was also noticed that the model is able to locate the least cost path in real time efficiently (15 seconds). Then the path can be represented by the X and Y coordinates of a user defined number of station points along the path (e.g. 60 station points).



FIGURE 6. A case study area with different land configuration

#### 4.2 VALIDATION TEST USING GA MODEL

As mentioned above, the same study area is redefined in the GA model. This is done so that the comparison and the verification between the two models are valid. The input parameters for the GA operators were as found by AL-Hadad (2011) [1] and are listed in below:

Population size (5000), individual length (60 station points), selection (based ranking scheme), multiple crossover points (up to 8 points, 4 segments), Mutation (8% individual rate, 4% uniform point mutation, 15% modified mutation point rate), termination criteria (up to 400 generation).

Figure 7 is the path result generated by the GA model. The path length was 12,013m, cost path amount 4,177,785 unit cost, and the running time was 385 seconds. A comparison table for the results of the two models is shown in Table 1.

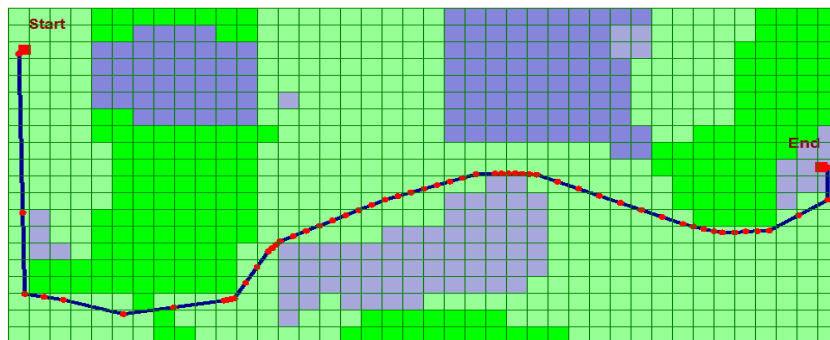

FIGURE 7. Path result from the GA model

TABLE 1. GIS and GA result parameters comparison

Comparison parameters	GIS model result	GA model result	% difference
Length, m	12,525.5	12,013	4
Cost path, unit cost	4,222,548	4,177,785	1.07
Process Time, seconds	15	385	96.1

It can be seen from the results of both GIS and GA that the two paths have common characteristics. However, the GIS process time is more efficient than the GA model. The GIS process time is 96.1% faster than the GA model process time.

## 5. CONCLUSIONS

A two dimensional GIS path search model has been developed. The cost function was based on land use and construction costs. A study area of 4000x8000m has been defined in terms of 200x200m grid cells. The cost of each land use and the construction cost at each cell are combined and attached to each cell through which the cost matrix of the whole study area is generated. Preliminary tests have been made upon known path result study areas and it was found successful. Then more case studies have been tested and the results were found promising.

Verification tests were also performed using a previously developed GA model [1]. The common characteristics of the results from both models verify the credibility and validity of both the GA and GIS models.

Thus, the GIS model result path can represent a centerline for a search corridor constrained by a user defined buffer or width.

From the analyzing the results of the model and the optimum horizontal alignment solution the following brief bullet points are concluded:

- The GIS model is able to locate a minimum cost path efficiently and effectively.
- The GIS model efficiently reduced the time required to search for a minimum cost path that makes the process of highway development cheaper in term of time.
- The GIS can provide a centerline path for a search corridor where the best horizontal highway alignment is located.
- GIS is able to produce a user defined number of point coordinates along the resulted path between the two termini points.
- GIS is capable to handle different cost models for further representation.
- GIS can make spatial data handy and areas of considerations are easily represented.
- The GIS may form an input to the GA model so that only smaller areas area searched.
- Reducing the search space from the whole study area to a corridor increases the efficiency of the GA search model.
- The GA model is no longer necessary to search the whole study area if it is assisted by a GIS search model.

## RECOMMENDATIONS

- The comparison of the results from the two models is promising and eagerly asks for further formulations and investigations.
- It is highly recommended to continue investigations on the possibilities for generating global highway alignments within the obtained corridor search space.
- Different buffer widths and cost entities based result comparisons are required.
- Further investigations are recommended for both horizontal and vertical highway alignments simultaneously as a 3D case.
- More costs and more possibilities like accessibility and environmental consideration inclusions may also need verifications on its important impacts on highway alignment development studies.

## REFERENCES

- [1] B. M. AL-Hadad, "An approach to the highway alignment development process using genetic algorithm based optimization," PhD thesis, The University of Nottingham, UK, 2011.
- [2] Wright, P.H. & Ashford, N.J., 1998. *Transportation Engineering: Planning and Design*, John Wiley and Sons, USA.
- [3] Shaw, J.F.B. and Howard, B.E., 1982. Expressway Route Optimization by OCP, *Journal of Transportation Engineering*, ASCE, 108(3), 227-243.
- [4] E.P. Chew, C.J. Goh and T.F. Fwa, "Simultaneous optimization of horizontal and vertical alignments of highways," *Transportation research, Part B*, vol. 23(5), pp. 315-329, 1989.
- [5] S.M. Easa, "Selection of roadway grades that minimise earthwork cost using linear programming, *Transportation Research*, Vol. 22A (2), pp. 121-136, 1988.
- [6] J. C. Jong, "Optimizing highway alignments with genetic algorithms," Ph.D. dissertation, University of Maryland, College Park, USA, 1998.
- [7] T. F. Fwa, W. T. Chan and Y. P. Sim, "Optimal vertical alignment analysis for highway design," *Journal of Transportation Engineering*, Vol. 128(5), pp. 395 – 402, 2002.
- [8] C.W. Tat and F. Tao, "Using GIS and genetic algorithms in highway alignment optimization, intelligent transportation system," vol. 2, pp. 1563-1567, 2003.
- [9] J. C. Jong and P. Schonfeld, "Cost functions for optimizing highway alignments," *Transportation Research Record*, 1659, 58-67, 1999.
- [10] M.K. Jha and P. Schonfeld, "Integrating genetic algorithms and geographic information system to optimize highway alignments," *Transportation Research Record*, 1719, pp. 233-240, 2000.
- [11] A. Maji and M.K. Jha, "Multi objective highway alignment optimization using a genetic algorithm," *Journal of Advanced Transportation*, vol.43 (4), pp.481-504, 2009.
- [12] D. Beasley, D. R. Bull and R.R. Martin, "An overview of genetic algorithms: Part 1 fundamentals," *University of Computing*, vol. 15(2), pp. 58-69, 1993.
- [13] K.B. Mathews, S. Craws, I. Mackenzie, S. Elder and A.R. Sibbald, "Applying genetic algorithms to land use planning," *Proceedings of the 18th workshop of the UK planning and scheduling spatial interest group*, University of Salford, UK, 1999.
- [14] M.J. Mawdesley, S.H. AL-Jibouri and H. Yang, "Genetic algorithms for construction site layout in project planning," *Journal of Construction Engineering and Management*, vol.128 (5), pp.418-426, 2002.
- [15] M.W. Kang, "An alignment optimisation model for a simple highway Network," PhD Thesis, University of Maryland, College Park, USA, 2008.
- [16] Wikipedia, [online] 2015, [https://en.wikipedia.org/wiki/Chromosome\\_\(genetic\\_algorithm\)](https://en.wikipedia.org/wiki/Chromosome_(genetic_algorithm)) (Accessed: 9 December 2015).
- [17] L. Davis, "Handbook of genetic algorithms," Van Nostrand Reinhold, New York, USA, 1991.
- [18] Z. Michalewicz, "Genetic algorithms + data structures = evolution programs," springer-verlag, USA, 1999.

## Evaluation of Using Total Station Instead of Level in Determining Elevations

Soran Polus Khorani<sup>1</sup>, Assist Prof. Kubad Zeki Henari<sup>2</sup>

<sup>1</sup>Erbil Technology Institute, EPU-K.R.-Iraq

<sup>2</sup>University of Salahaddin -Erbil, KRG-Iraq

<sup>1</sup>s.khorany61@yahoo.com

<sup>2</sup>kzhenari@yahoo.com

### ABSTRACT

The research is about the possibility of replacing Total Station for leveling instead of differential leveling for measurements of elevations during the preparation of Topographic maps. A site of 18.9km located in Erbil city was chosen to conduct the research. The study was undertaken for the same site using both level and total station instruments. The results obtained from both instruments were analyzed and arranged in tables. The comparison between the results of the two instruments revealed that using total station instrument can give more accurate results, save time, and reduce cost.

**Keywords:** Total station, Level, Elevation, Topographic maps.

## 1. INTRODUCTION

Differential leveling with an automatic level and graduated staff is the traditional surveying method used to establish the elevations or the difference in elevations. Accurate results obtained when all systematic errors were justified before using the level instrument, short sights length and balanced sights between back sight (BS) and for sight (FS) are the main restriction issues [1, 2].

It found that differential leveling is extremely expensive and time consuming especially in mountainous regions. Total station instrument nowadays are widely used in surveying, since the instrument is capable for the measurement of slope distances and vertical angles (That is indirect leveling method) to get necessary results in the application of many survey fields [3].

## 2. FIELD MEASUREMENTS

### 2.1 MEASUREMENT PRINCIPLES OF TOTAL STATION (INDIRECT LEVELING)

From instrument (Total station) station (A) (see Fig. 1): The slope distance SD and the vertical angle (V.an) to the center of the reflector at (B) are measured and the instrument height above (A) (HI) and the reflector height (HR) are measured. Then the elevation of (B) is determined by [3, 4, 5]:-

- In the case of V.an depression angle

$$\text{Elev. of } B = \text{Elev. of } A + HI - VD - HR \quad (1)$$

Where  $VD = SD * \sin V.an$

In the case of V.an vertical angle:-

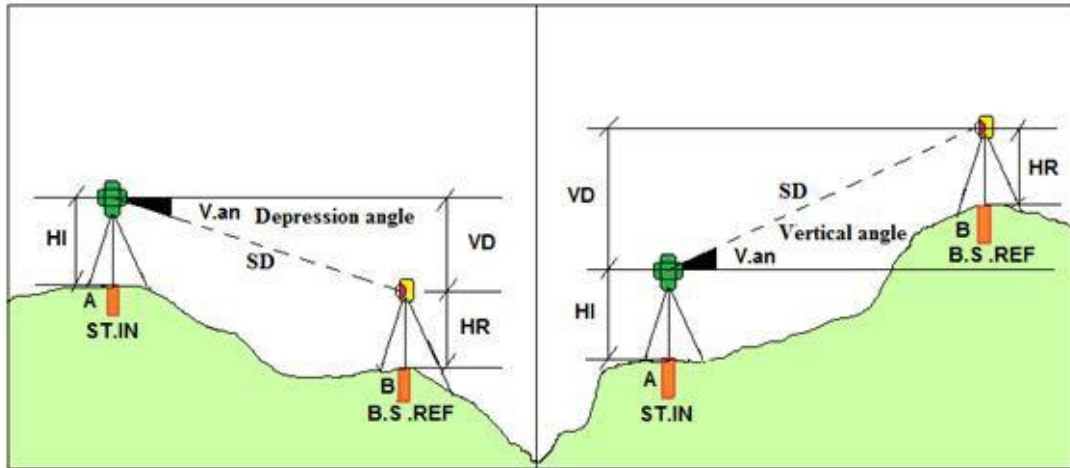

$$\text{Elev. of } B = \text{Elev. of } A + HI + VD - HR \quad (2)$$

FIGURE 1. The principles of the indirect leveling (Trigonometric leveling)

## 2.2 MEASUREMENT PRINCIPLES OF LEVEL (DIRECT LEVELING)

Leveling is the general term applied to any of the various processes by which elevations of points or differences in elevation are determined. It is a vital operation in producing necessary data for mapping. In this study the instrument level is set up approximately midway between ground points A and B (as shown in Fig. 2). First the instrument correctly leveled (in order to make the line of sight horizontal). The readings are taken on a graduated staff held vertically on points A and then point B.

If we consider the staff reading on A is back sight (BS) and the staff reading on B is fore sight (FS), and if the elevation at A = 100.00m with respect to a datum then the elevation at B = *Elevation of A + (BS - FS)*

OR Elevation of A + BS = *Height of instrument (HI)* Then the elevation of B = *HI - FS*

It is also possible to determine the difference in elevation between A and B as following [6, 7, 8]:

$$\Delta h_{AB} = BS - FS \quad (3)$$

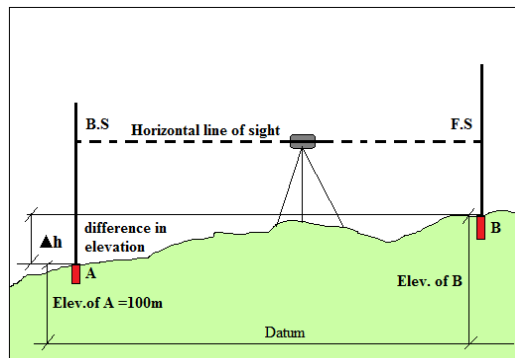

FIGURE 2. Measurement principles of leveling (Direct method)



## 2.3 RESEARCH FIELD DATA

A site was selected in Erbil for the field measurements. The site comprises of a route of 18.9 km length marked with bench marks in dimension of 20 \* 20 \* 50cm established at intervals of 150m as can be seen in Fig.3.

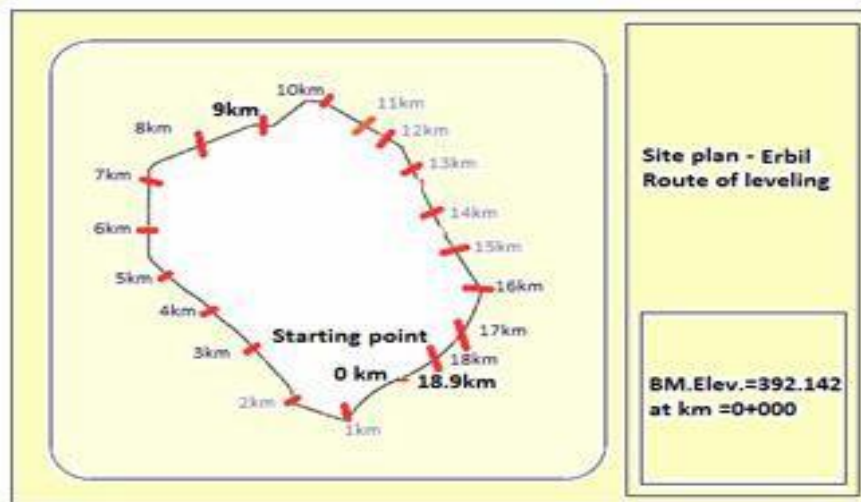

FIGURE 3. Site Plan Erbil- Route of leveling

The leveling procedure using Nikon Automatic Level instrument started from points 0 km. The first sight taken was (BS) to the staff held at that point. Then, several intermediate sights were taken. Finally another last staff reading (FS) was taken at a turning point (T.P) before moving the instrument to a new position. This procedure is repeated along the route until the starting point was reached again where the leveling has been closed

Number of setting up of the Nikon Automatic level were = 252

Total number of staff reading (BS, FS, and IS) were = 752

The leveling was carried out on the basis that the sight distance must not exceed 50m and balancing between BS and FS reading were maintained throughout. Fig 4 show surveying works and Nikon instrument us.

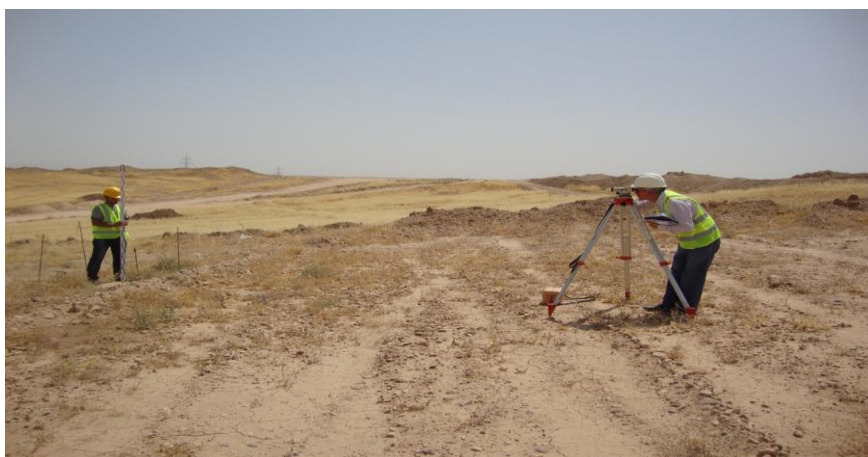

FIGURE 4. Nikon Automatic Level (field measurements)

Along the same route, a total station Leica Flexline Ts06 was used for determination of the elevation of the bench mark. A Total Station was set up at

a distance of about. 100m from starting point 0 km at a point of known coordinates. A reflector held at the starting point, and then the telescope of the total station was sighted to the reflector. The instrument directly calculates and stores the elevation of the points using the slope distance and vertical angle from the instrument station to that point. From this set up a total of (4-6) points were covered, before moving the total station to a new location.

Maximum sight length kept less than (210m)

Number of stations occupied by total station is (6)

Total number of observations:

At station No. 1 = 9

At station No. 2 = 10

At station No. 3 = 10

At station No. 4 = 10

At station No. 5 = 11

At station No. 6 = 5

$\Sigma$  of total No. = 55



FIGURE 5. Leica Total station TS06 (field measurements)

### 3. CALCULATIONS AND ADJUSTMENTS

#### 3.1 CALCULATION OF ELEVATIONS

A check of the quality of the leveling was made, before carrying out calculations of elevations.

#### 3.2 CALCULATION OF MISCLUSER

Misclouser =  $\Sigma BS - \Sigma FS$  Since the leveling is a closed loop,

Theoretically the misclouser must be equal to zero. However, due to the inherent errors caused by moving the instrument, the observer and the atmosphere there will be an amount of error varies from zero in plus or minus sign.

In this study:

$$\sum BS = 883.172 \text{ and } \sum FS = 883.221 \quad (4)$$

$$\text{Misclosure} = \sum BS - \sum FS = 883.172 - 883.221 = -0.049m$$

The allowable error According to the specification in third order leveling can be determined in the following way [9, 10, 11, 12].

$$\text{Allowable error} = \pm 12mm\sqrt{K}$$

Where; K is the length of the leveling route in kms. Therefore,

$$\text{Allowable error} = \pm 12mm\sqrt{18.9} = \pm 52.169mm.$$

Since the misclosure is less than allowable errors, the adjustment may proceed. The adjustment of this leveling is based upon the principle that

The errors will accumulate proportionally with respect to the distant from the starting points. - Adjustment for point (i)

Point (i) is located at distance (di) from the starting point (in km or m). - The correction for the elevation of point

$$i = \text{Misc} \times di \div \text{Total length of the leveling route.} \quad (5)$$

The corrections are applied in opposite sign of the misclosure.

On this basis, the elevations of all points were adjusted, and the condition of closed loop leveling was fulfilled. Comparison of result measured by total station and level instruments of the starting point. Table (1) shows the adjusted results data filed corrections that must be equal to the computed elevation of the same starting point.

TABLE 1.  
Comparison of results measured by total station and level instruments

Point No.	Adjusted Level Elevation (m)	Observed Total Station Elevation (m)	Diff. Level (m)	Point No.	Adjusted Level Elevation (m)	Observed Total Station Elevation (m)	Diff. Level (m)
1	392.142	392.142	0	28	383.988	383.94	0.047
2	391.193	391.192	0.002	29	385.065	385.016	0.049
3	390.256	390.252	0.004	30	387.155	387.104	0.051
4	390.23	390.225	0.005	31	389.035	388.982	0.053
5	389.828	389.821	0.007	32	385.965	385.911	0.054
6	390.547	390.538	0.009	33	383.028	382.972	0.056
7	390.38	390.37	0.011	34	382.455	382.397	0.058
8	390.37	390.357	0.012	35	402.148	402.089	0.06
9	390.559	390.545	0.014	36	403.6	403.538	0.061
10	390.672	390.656	0.016	37	404.043	403.98	0.063
11	390.542	390.524	0.018	38	402.906	402.841	0.065
12	389.634	389.615	0.019	39	404.515	404.448	0.067
13	389.927	389.906	0.021	40	403.367	403.299	0.068
14	390.366	390.343	0.023	41	401.664	401.593	0.07
15	389.44	389.416	0.025	42	402.727	402.655	0.072
16	388.967	388.941	0.026	43	379.716	379.643	0.074
17	387.944	387.916	0.028	44	381.47	381.394	0.075
18	387.38	387.35	0.03	45	383.703	383.626	0.077

19	386.997	386.965	0.032	46	388.048	387.969	0.079
20	387.316	387.283	0.033	47	387.811	387.73	0.081
21	388.455	388.42	0.035	48	385.465	385.383	0.082
22	386.72	386.683	0.037	49	395.808	395.723	0.084
23	385.73	385.691	0.039	50	393.269	393.183	0.086
24	383.807	383.767	0.04	.....	.....	.....	.....
25	384.255	384.213	0.042	124	18.45	389.05	389.098
26	386.122	386.078	0.044	125	18.6	391.114	391.162
27	383.117	383.072	0.046	126	18.75	391.944	391.993
				127	18.9	392.093	392.142
						- 0.049	0

### 3.3 OBSERVATION ANALYSIS

Usually topographic surveys are carried out covering small geographic area typically less than 4000 ha (10000 acres). With such areas simple survey techniques are employed to establish project control points. These surveys are plotted at scale from 1: 500 to 1: 5000 and at contour intervals of 0.5m or 1.00m. They are preformed to prepare a base map for detailed site plans.

Vertical accuracy: Vertical map accuracy is defined as the root mean square (rms) error in evaluation in terms of the project's evaluation datum for well-defined points only.

For class I. maps the limiting rms error in evaluation is set by the standard at one third the indicated contour interval for well-defined points only.

For class II & III maps compiled with limiting rms error for Twice or Three times of one third allowed form class I.

### 3.4 ROOT MEAN SQUARE ERROR METHOD

The “root mean square” rms error is defined to be the square root of the average squared discrepancies. The discrepancies are the differences in coordinates or elevations values as derived from the map and as determined by an independent check survey.

$$rms = \sqrt{D^2} \div n \text{ and } D^2 = d_1^2 + d_2^2 + d_3^2 + \dots + dn^2 \quad (6)$$

Where; D = discrepancies in elevations.

n = total number of points. Here;  $D^2 = 5.209m$

and n = 55 (Data from the table)

$$\text{Therefore, } rms = \sqrt{5.209^2} \div 55 = 0.31m \quad (7)$$

For large scales topographic maps the vertical interval of contour lines varies from 0.5m to 1.0m. Therefore:

When vertical interval  $VI = 0.500m$

$$VI \times 2 \div 3 = 0.500 \times 2 \div 3 = 0.33m \quad (8)$$

$$VI \times 3 \div 3 = 0.500 \times 3 \div 3 = 0.50m \quad (9)$$

When  $VI = 1.00m$

$$VI \times 2 \div 3 = 1.00 \times 2 \div 3 = 0.67m \quad (10)$$

$$VI \times 3 \div 3 = 1.00 \times 2 \div 3 = 1.00m \quad (11)$$

The (rms) obtained in our field study equal to 0.31m which is less than the allowable standards obtained above which are 0.33, 0.5, 0.67 and 1 m respectively. The results of the field data using both instruments are presented in Table (2). [13, 14, 15, 16].

TABLE 2.  
Results of points using both instruments and value of D

Point No.	Diff. Level (m)	Squared Diff. Level (m)	Point No.	Diff. Level (m)	Squared Diff. Level (m)	Point No.	Diff. Level (m)	Squared Diff. Level (m)
1	0	0	19	0.032	0.063	37	0.063	0.126
2	0.002	0.004	20	0.033	0.067	38	0.065	0.13
3	0.004	0.007	21	0.035	0.07	39	0.067	0.133
4	0.005	0.011	22	0.037	0.074	40	0.068	0.137
5	0.007	0.014	23	0.039	0.077	41	0.07	0.14
6	0.009	0.018	24	0.04	0.081	42	0.072	0.144
7	0.011	0.021	25	0.042	0.084	43	0.074	0.147
8	0.012	0.025	26	0.044	0.088	44	0.075	0.151
9	0.014	0.028	27	0.046	0.091	45	0.077	0.154
10	0.016	0.032	28	0.047	0.095	46	0.079	0.158
11	0.018	0.035	29	0.049	0.098	47	0.081	0.161
12	0.019	0.039	30	0.051	0.102	48	0.082	0.165
13	0.021	0.042	31	0.053	0.105	49	0.084	0.168
14	0.023	0.046	32	0.054	0.109	50	0.086	0.172
15	0.025	0.049	33	0.056	0.112	51	0.088	0.175
16	0.026	0.053	34	0.058	0.116	52	0.089	0.179
17	0.028	0.056	35	0.06	0.119	53	0.091	0.182
18	0.03	0.06	36	0.061	0.123	54	0.093	0.186
						55	0.095	0.189
The square of discrepancies in elevations (D) <sup>2</sup>								5.209

#### 4. CONCLUSION

The study evaluates the possibility of using total station instead of level instrument to prepare topography maps. Generally, the results show that using total station in preparing topography maps can lead to more accuracy, time saving and cost-effective.

1. Restriction cannot be an issue on sight length for total station observation.
2. No need to balance back sight and fore sight lengths, this makes the choice of location for instrument and the reflector more convenient.
3. In using total station instrument, line of sight above the ground can be maintained at maximum because the observation is always to the top of the reflector.
4. Using total station instrument the sight of the reflector can be changed to overcome situations where obstructions to the line of sight would interfere.
5. Using total station instrument the method is considered to be faster and less time consuming.
6. The accuracies are compatible and may be applied in many fields.

7. Elevation results close to the level instrument elevation having better rms fit with the specifications.

## REFERENCES

- [1] Dr AM Chandra Problem solving with theory and objective Type Questions pp (60).
- [2] John D. Bossier. Moffitt, Francis H. "SURVEYING"– 10th ed. P. cm. (ch 3-page - 61)
- [3] Dr. B.C Punmia Ashok k. Jain Arun K . Jain "SURVEYING 111 Higher surveying.
- [4] Brinker." The surveying hand book / editors, Russell C. Brinker & Roy Minnick, - 2ndEd. P. cm . 1994. (ch 7 – page - 4 – 115 ).
- [5] Johe Muskett ,Black well Science, Site Surveying,– 1995 – 2 th Ed – p. c, (ch 2- page - 11), (chapter 2- page - 28).
- [6] D.Ghilani and Paul R. Wolf ,ELEMENTARY SURVEYING, An introduction to Geomatics Twelfth Edition Charles).
- [7] NIWA. Leveling & surveying. Pacific island Hydrology course Fiji April 2004(chapter 3 –page - 1).
- [8] William Frank ,Surveying for Engineers .J .Uren 2006 – (page 135).
- [9] Barry. F. Kavanagh ed "Surveying principles & Applications".p.cm (2006). pp (1-3).
- [10] James R. Wirshing .Roy .H. Wirshing , Introductory Surveying Schaums.2003.
- [11] S. K. Roy ,Fundamentals of Surveying by, 1999 by prentice Hall of India private – 2006 (ch-5- page 86 – 114).
- [12] Bureau of the Budget (1947), "United States National Map Accuracy Standards", U.S. Bureau of the Budget, June 17ANSI (1982), "Procedures for the Development and Coordination of American National Standards," American National Standards Institute, 1430 Broadway, New York, NY 10018, Sept. 1, 1982
- [13] The American Society for Photogrammetry and Remote Sensing Approval by the ASPRS Professional Practicing Division, March, 1990.
- [14] B .C. Puma, Ashok Arankk Jain, Kumar Jain Mehra offset press, Delhi Surveying Vol. - 2- by– 2005.
- [15] 2006 California Department of Transportation CALTRANS, Surveys manual 8-7 Leveling Survey Specifications, September 2006.
- [16] Federal Geodetic Control Committee (1984), "Standards and Specifications for Geodetic Control Networks", Federal Committee, Sept

## **Validation of 2d-Deformable Numerical Model Used in Behaviour's Simulation of Laminated Glass Panels Subjected to Bending Loads and Effects of Layers Thickness on the Maximum Principle Stress**

Rasha AL-Kabbanie <sup>1</sup>

Dr. Mohammed Fathi Ganameh <sup>2</sup> , Dr. Mohallab AL-Dawood <sup>3</sup>

<sup>1</sup> *Ishik University –Faculty of Engineering – Erbil /Iraq*

<sup>2</sup> *Université Internationale de Rabat - Aerospace Engineering School – Morocco*

<sup>3</sup> *Damascus University – Faculty of Mechanical and Electrical Engineering – Department of Mechanical Conception – Syria*

<sup>1</sup>*rasha.alkabbanie@ishik.edu.iq,*<sup>2</sup>*fathi.ghanameh@uir.ac.ma*

### **ABSTRACT**

Nowadays, laminated glass is considered one of the most important types of safety glass ,that is due to its ability to fulfill security requirements of people and properties .The Failure behavior of laminated glass has been studied in varied loading cases using many experimental and numerical methods.

In this article, a 2d-Deformable Numerical Model was suggested to be used in simulation of laminated glass sheets behavior subjected to bending loads. The interlayer was considered as a hyper-elastic material whereas the glass was modeled using the linear elastic module. This model was validated through 4-point bending test. For a further validation of this “2d- bending” Model , the effect of various geometric parameters of the laminated glass panels on the maximum principal stress was studied numerically and compared with experimental results mentioned in the reference study [6] .

**Keywords:** Numerical Modeling, Numerical Simulation, Laminated Glass, 4-Point Bending Test, Maximum Principal Stress.

### **1. INTRODUCTION**

As a result of the increasing of risks affecting both people and properties , such as burglaries, ballistic attacks and explosive blast attacks , the need of developing glazing systems which can full fill the security requirements has raised, also it became so important to study the behavior of these glazing systems in different loading cases .

Nowadays, Safety Glass is wide spread in industrial and structural application. Generally, glass types can be classified by both the fracture behavior and the size of the fragments after impact.

Some types of safety glass are: Tempered Glass , Heat Strengthened Glass , Chemically Strengthened Glass , Laminated Glass ... etc [1].

Laminated glass is an assembly comprising at least two panels of glass (which can be either float or tempered) bonded together across their entire surface by an interlayer (which can be either Poly Vinyl Butyral (PVB) or Ethylene Vinyl Acetate (EVA) or others ...), the bond between the glass and the interlayer ensures that the broken pieces remain in place [2].

Laminated glass can be used in many applications, such as architectural structures, anti bullet systems, windscreens ... etc. [3].

Manufacturers usually evaluate the behavior of laminated glass using destructive tests, such as : Pendulum Test , Falling Ball Test , Bending Test , Pummel Test , Compressive Shear Test ...etc. , but these destructive tests are expensive in terms of time and money[4].

Modeling laminated glass and using numerical simulation can both save money and time and provide further ability to control the boundary conditions [5]. Therefore, many attempts have been done to find a laminated glass model that can describe well the behavior of the glazing structure. Many relevant studies on laminated glass modeling have been experimentally and numerically performed.

F.W.Folcker [6] invented a model for the laminated plate using two solid elements for the glass plies with Linear-Elastic behavior and a solid element for the PVB interlayer with Linear-Viscoelastic behavior. The researcher has done simulation of the impact test which in a chromic-steel ball falls on a laminated glass plate with an initial velocity equals to 2 m/s .

Also, S. J.Beanison [7] studied the relation between the applied load and the maximum principle stress; it was found that increasing the applied load causes a linear increasing in the maximum principle stress.

In study [8] D.Z Sun has modeled laminated glass panel using two shell elements with a Linear Elastic properties for both the internal and external glass plies , and a solid element with Hyperplastic behavior for the PVB layer . For validation, a simulation has been made of 3-Point Bending Test using ABAQUS EXPLICIT, it was found that there is a good agreement between the numerical and the experimental results.

Whereas, M.Timmel [9] has modeled laminated glass panel using two shell elements for the internal and external plies with Elastic/Brittle behavior and a membrane element for PVB layer with Hyperplastic behavior. For validation, the researcher did simulation for Roof Cash test with an initial velocity (2m/s). The numerical results were in a good agreement with the experimental ones especially regarding the relation between the applied load and the discernment.

In previous researches , 3-d complicated numerical models were used to simulate the laminated glass behavior which requires long time for processing , whereas , in this research a 2d-deformable numerical model was suggested to be used in simulation of laminated glass sheets behavior subjected to bending loads. The interlayer was considered as a hyper-elastic material whereas the glass was modeled using the linear elastic module.

Also , For Further validation of this “2d- bending” Model , the effect of various geometric parameters of the laminated glass panels on the maximum principal stress was studied numerically and compared with experimental results mentioned in the reference study [6 ]

## **2. METHODOLOGY**

### **2.1. NUMERICAL MODEL**

When a structure is subjected to uniform bending loads, the effects within only the cross section can represent the effects on the entire pattern , therefore , a 2d-deformable model was suggested to simulate the behavior of laminated glass plates



subjected to the 4-point bending test , using Abaqus/Static . a 2d - 4 nodes solid element CPS4R was used in this model [10]. Modeling steps were as the following:

- 1- The glass plates were modeled with a linear-elastic module and PVB foil was modeled with a hyper-elastic module / Mooney-Rivlin type , according to the following parameters :  
( $C_{10} = 1.45 \text{ Mpa}$ ,  $C_{01} = 0.06 \text{ Mpa}$ ,  $D_1 = 0.013 \text{ Mpa}^{-1}$ ) [11].
- 2- A static step was used, the incrementation type was automatic, the maximum number of increments was 100 and the size of the increment ranges between (0.001, 1) mm.
- 3- The model was meshed as the size of each 2-d element is (2mm  $\times$  2mm).
- 4- For the boundary conditions, two degrees of freedom was restricted in the support points and a force of 150kgs was applied on each loading point.



FIGURE 1. Numerical Model subjected to loads

## 2.2. EXPERIMENTAL PROCEDURE

The experimental procedure in this research is the standard 4-point bending test [12] .the experiments were done in the Quality Laboratory at Madar Company-Damascus/Syria. Figure 2 shows a photo of the test set. In this experiment, five laminated glass samples with the following dimensions were tested;

Length = 100 cm , Width = 100 cm.

Thickness of the first glass ply = 2.5 mm.

Thickness of the second glass ply = 2.5 mm.

Thickness of the PVB interlayer = 0.38 mm.

The samples were put on two cylindrical supports and loaded by two rigid cylinders.



FIGURE 2. Four-Point Bending Test Set

Also, Figure 3 shows a Scheme of the applied loads and supports positions.

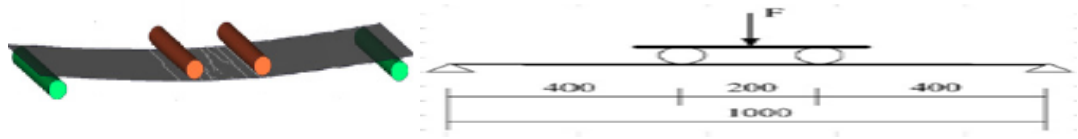

FIGURE 3. Scheme of the applied loads and supports positions

### 3. DISCUSSIONS AND RESULTS

Table 1 shows the experimental displacement values vs. loads for the five specimens and the average values of the displacements.

Note: The displacement in the following discussion and Figures belongs to the midpoint of the inner glass ply of the laminated glass specimen.

TABLE 1.  
Experimental Displacement Values Vs. Loads for the five specimens

Load (kg)	Displacement(mm)					
	P1	P2	P3	P4	P5	Average
15	0.38	1.06	1.82	0.39	1.51	1.03
30	0.41	1.45	3.11	0.80	3.29	1.81
45	0.97	1.70	4.60	1.10	3.90	2.45
60	1.60	1.90	5.90	1.50	5.60	3.30
75	2.57	3.50	5.97	2.05	6.15	4.05
90	3.07	4.30	6.10	2.90	6.95	4.66
105	3.55	4.40	6.38	3.50	7.23	5.01
120	4.05	4.60	6.62	4.13	8.50	5.58
135	5.55	5.15		5.63	9.38	6.43
150	6.44			5.93	9.77	7.38

Also , Figure 4 shows the Numerical Maximum Principle Stress  $S_{max}$  distribution along the model after applying the 4-point bending test loads .

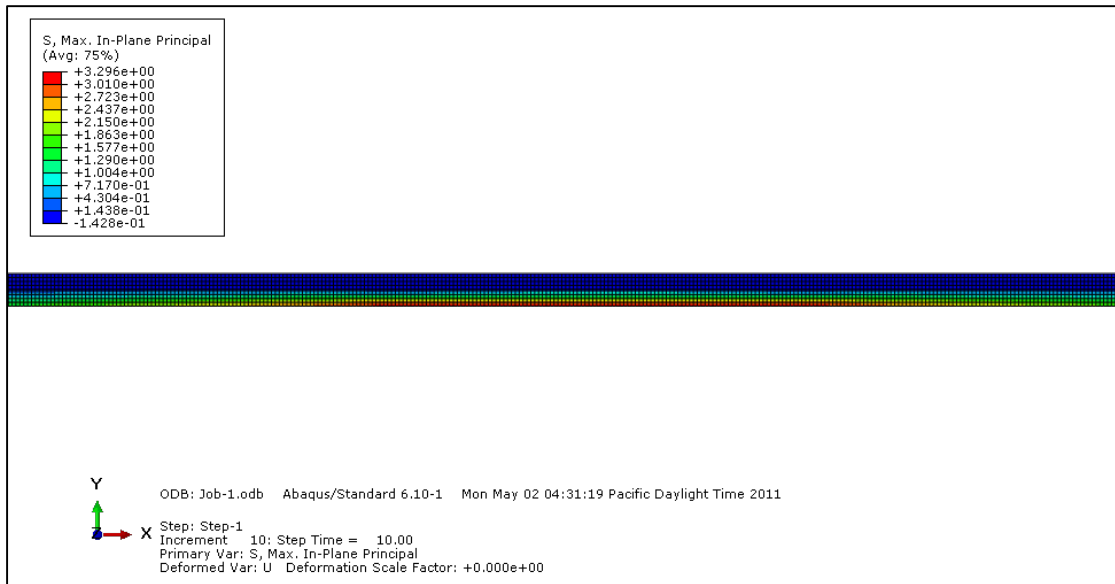

FIGURE 4. Numerical Maximum Principle Stress  $S_{max}$  distribution along the model

Figure 5 shows the experimental displacement vs. load curves in comparison with the numerical curves, it is obvious that both plots show similar trends and the numerical results are in a relatively good agreement with experimental values, so it can be realized that the "2d-bending" model behaves pretty well in simulation of laminated glass subjected to bending loads.

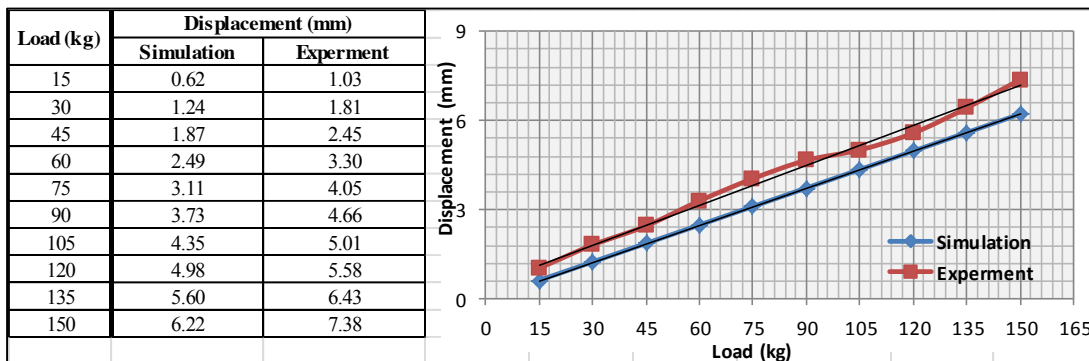

FIGURE 5. Experimental Displacement Vs. Load Curves in comparison with the numerical curves

For Further validation of this “2d- bending” Model, the effect of various geometric parameters of the laminated glass panels on the maximum principal stress was studied numerically and compared with experimental results mentioned in the reference study [6], as the followings:

1- The effect of outside and inside glass ply thickness on the maximum principal stress:

Figure 6 shows the Numerical Maximum Principle Stress  $S_{max}$  vs. external glass ply thickness curve in comparison to the experimental results mentioned in the reference research [6].

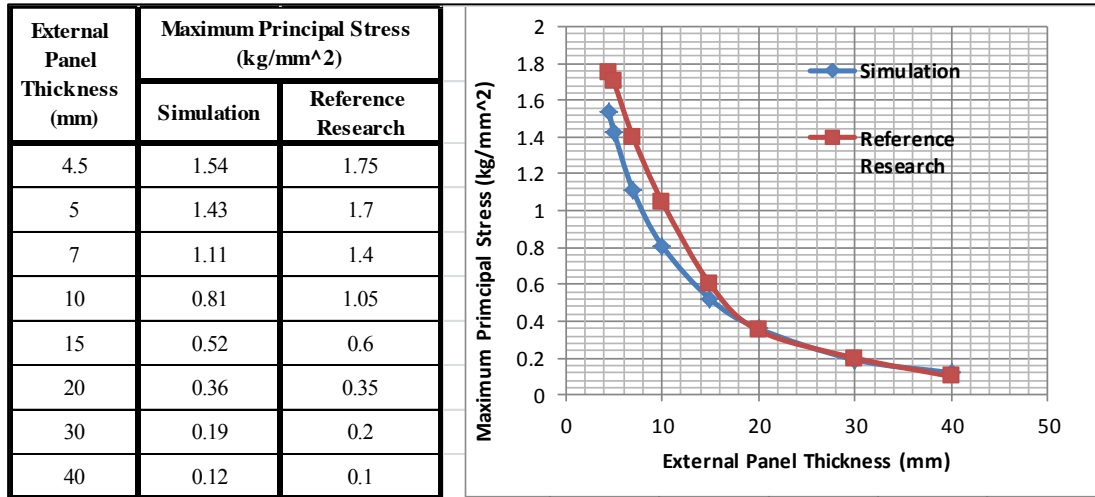

FIGURE 6. Numerical Maximum Principle Stress  $S_{max}$  vs. outside glass ply thickness curve in comparison to the experimental results mentioned in the reference research [6]

Also, Figure 7 shows the Numerical Maximum Principle Stress  $S_{max}$  vs. internal glass ply thickness curve in comparison of the experimental results mentioned in the reference research [6].

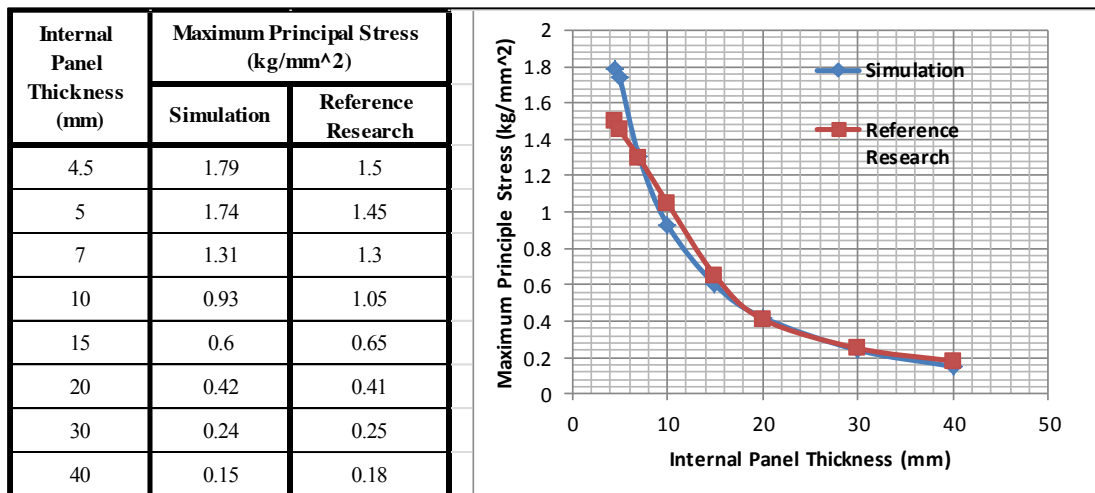

FIGURE 7. Numerical Maximum Principle Stress  $S_{max}$  vs. internal glass ply thickness curve in comparison of the experimental results mentioned in the reference research [6]

It can be realized that both plots show similar trends ; a region of high return for added thickness in which the maximum principal stresses are reduced significantly, followed by a region where significant added thickness does a little to a further reduce the stress .

It is also obvious that numerical results agree well with the experimental results mentioned in the reference research [6].

2- The effect of PVB interlayer's thickness on the maximum principal stress: Figure 8 illustrates the Numerical Maximum Principle Stress  $S_{max}$  vs. PVB interlayer thickness curve in comparison with the experimental results mentioned in the reference research [6].

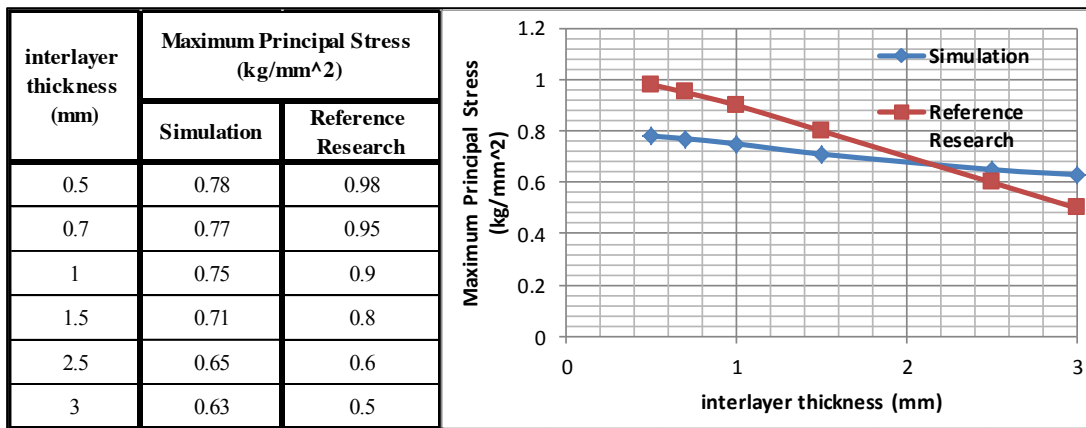

FIGURE 8. Numerical Maximum Principle Stress  $S_{max}$  vs. PVB interlayer thickness curve in comparison with the experimental results mentioned in the reference research [6]

As shown in the above Figure , the trend is a reduction in the maximum principle stress when PVB thickness increases and the numerical results relatively agree well with experimental results mentioned in the reference research [6] .

3- The effect of the applied load on the maximum principal stress:

Figure 9 shows the Numerical Maximum Principle Stress  $S_{max}$  vs. applied load curve in comparison of the experimental results mentioned in the reference research [6].

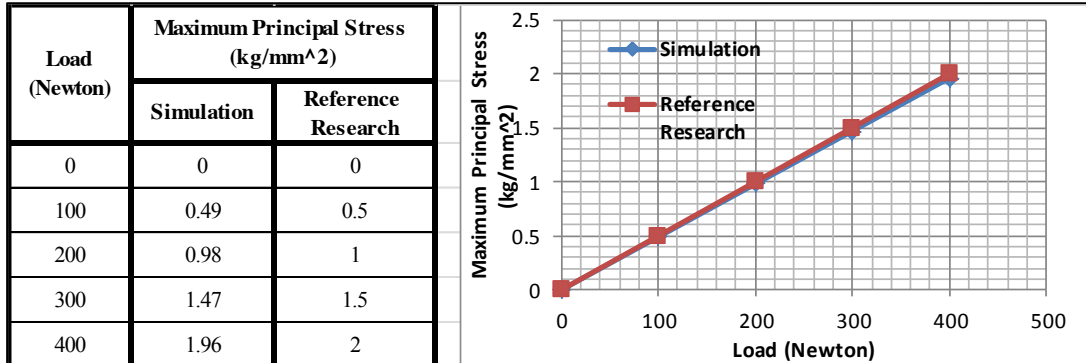

FIGURE 9. Numerical Maximum Principle Stress  $S_{max}$  vs. applied load curve in comparison of the experimental results mentioned in the reference research [6]

The Figure shows that the Maximum Principle Stress  $S_{max}$  increases proportionally with the applied load, and that there is a very good agreement between the simulation results and the experimental results mentioned in the reference research [6]

#### 4. CONCLUSIONS

1. The suggested 2d-Elastic Deformable Model with Hyper-Elastic module for the PVB interlayer and Linear Elastic module for the glass panels has been validated to be used successfully in simulation of the 4-point bending .

2. The Maximum Principle Stress increases – with a nonlinear trend- as the thickness of external glass panel decreases.
3. The Maximum Principle Stress increases – with a nonlinear trend- as the thickness of internal glass panel decreases.
4. The Maximum Principle Stress increases – with a linear trend- as the thickness of the polymeric interlayer decreases.
5. The Maximum Principle Stress increases – with a linear trend- as applied load increases.

## RECOMMENDATIONS

1. The effect of other factors and parameters other than the geometric factors on the laminated glass strength can be studied.
2. Other types of laminated glass with different types of interlayer can be used in a similar research.
3. Checking the validity of the suggested 2d-elastic model subjected to 3-point Bending loads.

## REFERENCES

- [1] M. Neal, “security glazing products,” 1996.
- [2] “glass handbook,” Arinoduglass.
- [3] A. Fam, “structural performance of laminated and un-laminated tempered glass under monotonic transverse loading,” *construction and building materials*, vol. 20, pp. 761-768, 2006.
- [4] D. U. Keller, “adhesion in laminated safety glass ”, *construction and building materials*, vol. 8, pp. 353-356, 1999.
- [5] L. Kuruvita, “numerical investigation of low velocity impacts on monolithic and laminated safety glass.”
- [6] F.W.Flocker, “stresses in laminated glass subject to low velocity impact,” *Engineering structures*, vol. 19, no. 10, pp. 851-856, 1997.
- [7] S. J.Bennison, “high performance laminated glass for structurally efficient glazing”, Wilmington-USA, 2008.
- [8] D-Z.Sun, “modeling of the failure behavior of windscreens and component tests”, *European LS-DYNA users conference*, Weissach-Germany, 2005.
- [9] M.Timmel, “a finite element model for impact simulation with laminated glass,” *international journal of impact engineering*, vol. 34, pp. 1465-1478, 2007.
- [10] the ABAQUS 6.9 documentation.
- [11] B. Weller, “interlayer materials for laminated glass,” *glass in it style*, vol. 10, pp. 14-19, 2007.
- [12] the AGC group, “all about glass,” yourglass.

## 5G Technology: A review

Bayar Shahab<sup>1</sup>, Rebaz Salih<sup>2</sup>

<sup>1</sup>*Department of Computer Engineering, Ishik University, Erbil, KRG-Iraq*

<sup>1&2</sup>*Department of Computer science and Engineering, University of Kurdistan-Hewler, Erbil*

<sup>1</sup>*b.aziz@ukh.edu.krd*, <sup>2</sup>*r.hamad@ukh.edu.krd*

### ABSTRACT

Fifth generation of mobile technology abbreviated as 5G is thought to be the newest and most significant advancement in wireless and mobile communication in the current era. 5G makes its diversity with older generations of mobile technology by its amount of connections of more than 100 billion devices, 10 Gb/s (Gigabyte/second) peak data rate, very low latency of 1 ms(millisecond), very low energy consumption of 10% of the current 4G technology. All of the mentioned features and even more than these will make this technology a revolutionary and the most spectacular technology among all. This paper will discuss 5G characteristics along with its functionalities and finally the challenges facing this technology will also be stated.

**Keywords:** 5G mobile communication, QoS, Security, interference, cost.

### 1. INTRODUCTION

“In a few years, you may be able to download a full-length HD movie to your phone in a matter of seconds rather than minutes. And video chats will be so immersive that it will feel like you can reach out and touch the other person right through the screen” [1] that was stated by the senior editor of the recode tech news website. It basically refers to two major characteristics (features) of 5G technology which are the high data rate and very low latency. The progresses and advances in wireless and mobile communication have gone so deep in this century and that is due to the rapid evolvement of the mobile technology. Nowadays, our mobile phones are utilized for messaging, video and voice calling, internet browsing and more. Almost every 10 years a new generation of mobile technology has been released. Mobile technology has been through very long improvements from 1G which was only analog calling to 2G which was first digital phone call and messaging. Then, 3G emerged with better enhancements and released to add up the data or multimedia transmission. Finally, LTE or 4G brought outstanding features that support IP service like (messaging, voice and video). Yet, ambitions and desires are more from the telecommunications companies as business industries/markets and people’s life is changing. Thus technology must cope with these rapid changes.

This paper sheds the light on some valuable literature reviews followed by 5G characteristic which will concentrate on the features of 5G and its pro and cons with current LTE (4G) technology. Then, 5G architecture is discussed. After that. The functionality of 5G is argued followed by problems related to that technology. Lastly, it concludes the review done on this leading technology and presents acknowledgment to the helps the paper has received.

## 2. LITERATURE REVIEW

Agreement on one standard definition for 5G has not yet been made because it is still under development and each organization has its vision it. It is anticipated that by 2020, 5G will be revealed. NGMN Alliance (Next Generation Mobile Network Alliance) has its vision on 5G as following “5G is an end-to-end ecosystem to enable a fully mobile and connected society. It empowers value creation towards customers and partners, through existing and emerging use cases, delivered with consistent experience, and enabled by sustainable business models” [2]. GSMA intelligence (Group special Mobile Association intelligence) has broken down its vision into two views, the hyper-connected vision and Next generation radio access technology. The first view proposes a mixture of older generations of mobile technology from 2G to 4G and Wi-Fi to build a network of higher density for devices, covering more area, to be available and support IOT (internet of things) while the other view intends to build new radio interfaces rather than existing one to meet the features of 5G [3]. 5G is expected and promised to have revolutionary features as machine-to-machine, human-to-human and human-to-machine communications which will ultimately create a smart environment for overall businesses and the world infrastructure on the other side. New business demands and user requirements will lead to the innovation of new uses cases. According to GSMA intelligence, NGMN alliance and NOKIA Company [4], some common use cases are:

- Mobile broadband access(beyond normal internet access)
- High user mobility in terms of connectivity and autonomous driving/connected cars
- Smart society (smart office, home, city etc.)
- Internet of Things (IoT)
- Ultra reliable services(i.e. E-health)
- Extreme real time communications(Augmented reality or tactile internet)

FIGURE 1 shows the METIS’s (Mobile and wireless communications Enablers for the Twenty-twenty (2020) Information Society) timeline of 5G development phases [5]:



FIGURE 1. 5G development timeline [5]

### 2.1 5G CHARACTERISTICS

5G technology is required to provide new capabilities to businesses and users in terms of features and quality of services and that is what makes 5G to be different than other mobile technologies. These new characteristics will boost the business industry and change the way we used to utilize the mobile technology. We list some of common 5G characteristics with brief explanation for each of them:



- Low latency of less than 1 millisecond that will be more appropriate and supports real-time applications with lowest error rate ever.

FIGURE 2 shows the LTE vs. 5G latency time provided by GSMA [3]:

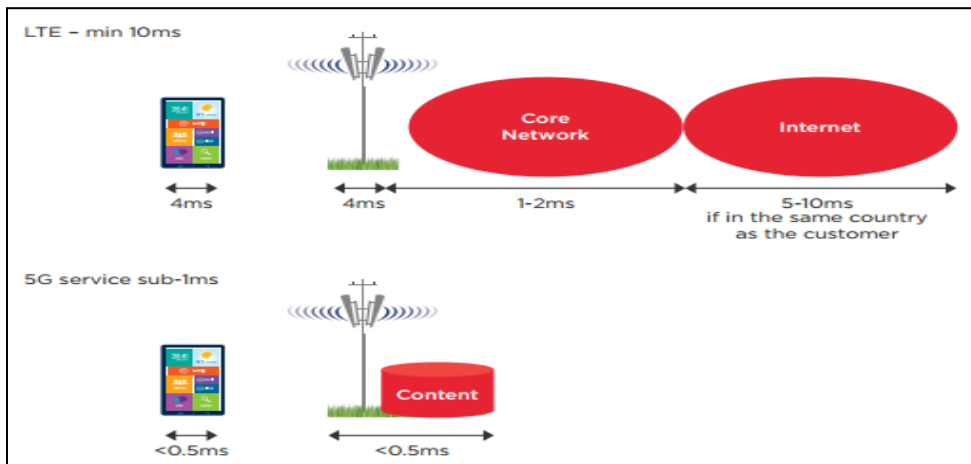

FIGURE 2. Latency time between 4G and 5G [3]

- 5G will provide the peak data rate of 10 Gb/s
- Peak value of 100 Mb/s data rate to give to at least %95 of the user in the network including the cell-edge.
- 5G will provide connections for 1 million devices/km<sup>2</sup>
- Very low energy consumption of %10 of the current 4G technology that will enhance the battery life to 10 years for low power machines/devices.
- The availability of the 5G system is promised to be %99.999.
- 5G is ultra-reliable of %99.999.
- The coverage area is %100 in 5G.
- Support 500km/h mobility speed. Imagining a very fast train of speed 500/h with continuous connection and without any interruption.
- It will support massive capacity of 10Tb/s/km<sup>2</sup>
- Due to its improvements and increased number of connected devices and device-to-device communications, it will provide high level of security.
- Improving the energy efficiency will decrease the overall cost of the 5G technology and systems.

5G has many advantages over current 4G technology, TABLE 1 illustrates the pros of 5G over 4G:

TABLE 1.  
Pros of 5G over 4G

Features	4G	5G
Bandwidth/speed	100-300Mbps	1 Gbps and above
Latency	Less than 1 millisecond	5-10 milliseconds
Services	Dynamic information access with wearables	Dynamic information access with more wearables
# of devices	8 billion connections by 2017	100 million connections by 2020
Power consumption	Too much	%10 less than current 4G



## 2.3 5G FUNCTIONALITIES

### 2.3.1 5G QUALITY OF SERVICE

Quality is a crucial point of evaluation of any system, and in this case, 5G is expected to have a considerable quality of service. The expectations are quite high as comparison to the other previous generations such as 3G and 4G, but it does not mean to be a replacement of them. It will be the advancement of the ongoing process the other previous generations. In 5G, the main focus would be on the quality and reliability as it is stated “We need to put the quality of the experience at the core of 5G. Of course our customers want to be connected at high-speed 5G, but they want to be connected at all times” [7]. As technology advances, the demands of mobile operators increase, because it brings more attraction to the users to consume more and more bandwidth for example utilizing video services. Plus, the capacities of the operators decrease when the traffic density increases. 5G is could provide high capacity to overcome the capacity issues existing in other previous versions. There might be many more features serving the quality, and would arise as surprise to the networking world technology. There are many factors underpinning 5G to support higher spectrum as illustrated in FIGURE 4 [9]:

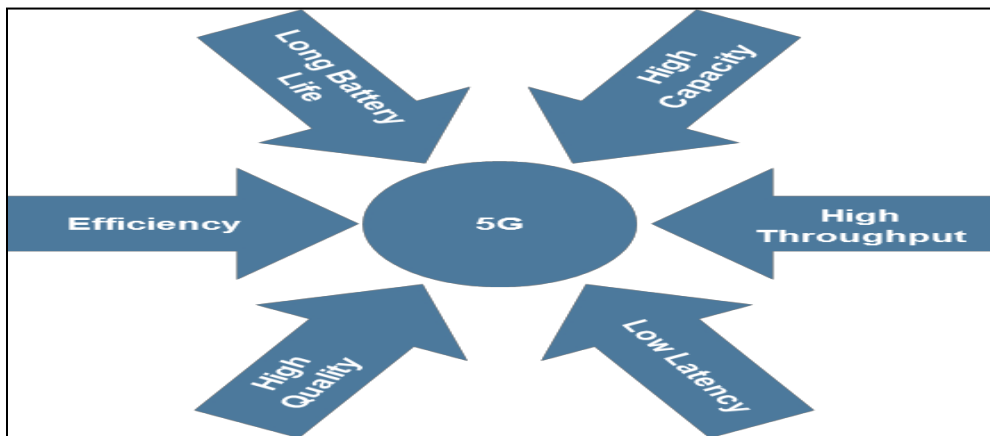

FIGURE 4. QoS [9]

“5G network infrastructure will be based on the use of cloud technologies, both in radio access networks (Cloud RAN) with using SDR (software defined radio) infrastructure and in core network (Cloud CN) with using SDN (software defined network) infrastructure”[8].

### 2.3.2 SECURITY

Security is a major functionality of any existing system. “Mobile networks will increasingly become the primary means of network access for person-to-person and person-to-machine connectivity. These networks will need to match advances in fixed networking in terms of delivered quality of service, reliability and security” [9]. A vision toward the 5G security varies from one to another. As the speed of communication is expected to be hundreds of times faster than 4G then the probability of spreading virus, Trojan, worm etc. increases the level of unsafety as issue so the security of 5G must overcome these issues with practical methods and algorithms. There are issues that are challenging to the security of 5G as Dave Waterson on security focuses on three points [10]. Firstly, it is challenging when billions of devices are connected because it is exposed to the security threats. Secondly, as the data transfer speed gets increased, the malicious files are transferred

too regardless the size of the malicious files. Thirdly, security breaches might bring considerable consequences to the ground for example when 5G technology is launched driverless cars might come to play its role in the ground, and if security breaches what could happen, of course things that are not expected or worse than that.

### **2.3.3 MOBILITY**

Mobility is a seamless service provides the service to the users that are moving and not a standing in a fixed position. The 5G is expected to provide and support mobility for a number of needed devices. In addition, it should support high mobility such as airplane. Based on a NGMN 5G paper, the mobility requirements for 5G depend on a number of specific use cases such as the following [2]:

#### **2.3.3.1 HIGH SPEED TRAIN**

Nowadays high speed trains are being used in many developed countries, and expected to be used in the future beyond 2020 in many countries which as the speed of 500 km/h. the passenger of these trains might watch high quality movies, play video games, of video chatting or telework. These will need a sufficient quality of service to convince the passengers at this speed which is a great difficult task to handle.

#### **2.3.3.2 REMOTE COMPUTING**

Remote computing is an important part of some people who run business or who are involved in it or stakeholders of it. Imagining that beyond 2020 it will be more utilized and built into the life of people literally. Remote computing would be used to by users even when users go at high speeds by any transportation means, and this needs a strong and steady communication with no or a very low latency.

#### **2.3.3.3 MOVING HOT SPOTS**

The capacity will be a challenge beyond 2020 because there will be more moving vehicles and big events may arise which might affect the capacity. That would be requiring more optimization. 5G could provide a high capacity tackle down these issues.

#### **2.3.3.4 THREE DIMENSIONAL (3D) CONNECTIVITY**

Beyond 2020, the connectivity services will be implemented in the civil aviation's the same as they are on the ground and the altitude of an aircraft is about 12 km. An example of three dimensional connectivity is the sporting events, for example the user moves in the air using balloons or skydiving which is high above the ground.

### **3. PROBLEMS RELATED TO 5G**

While the 5G technology has not stepped out into the real world, it would be quite unfair to talk about the difficulties that are related to it, but as the rest of other technologies there would be some problems. For now, there are some problems expected to emerge with 5G technology. As there are chatters among professionals about 5 G technology and each of them is proposing their own vision towards 5G

technology. Hereby the agreement on standardizing 5G becomes challenging. Another problem related to 5G technology is building new infrastructure for the deployment of this technology for example new radio interfaces and more base stations etc. “Latency is one of the risk areas for 5G. If it is not dealt with right, with cars and all the other industries that will depend on it in mind, it could be a real problem for the standard” [11]. Below FIGURE 5 shows some more common challenges that are related to 5G technology:

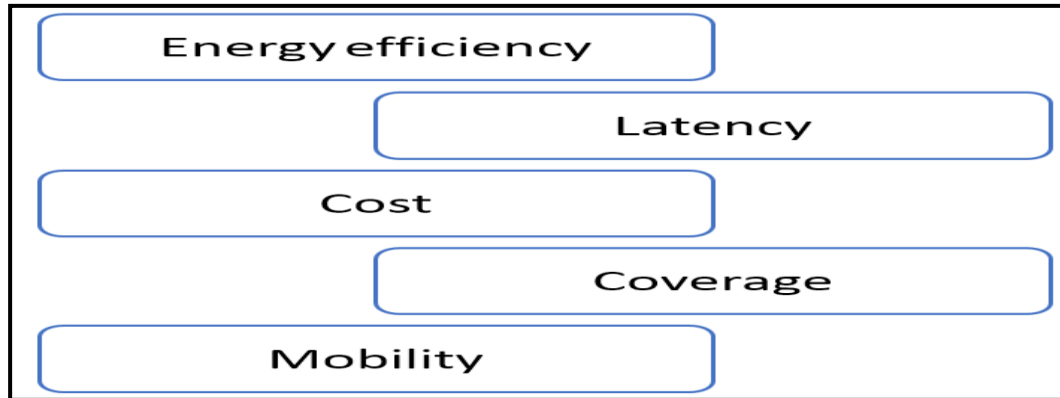

FIGURE 5. Problems related to 5G

### 3.1 ENERGY EFFICIENCY

It's been promised that 5G technology will provide 90% energy efficient than current existing technology (4G/LTE). As its obvious energy efficiency in mobile and networking is how many bits transmitted per Joule [2].

### 3.2 LATENCY

As aforementioned, in 5G technology the time of latency is expected to be less 1 millisecond which is totally different from other previous mobile technology that is how 5G overcomes 4G. Obtaining one millisecond is a challenging task because physical devices must be built to cope with one millisecond in order to maintain real time application such as augmented reality and e-health services etc.

### 3.3 COST

Big companies such as Huawei and Nokia are both believe that users of 5G shall not be charged more than the cost of the current technology [1]. On the other hand, bringing such technology to the ground is a difficult task because currently nobody can estimate how much 5G devices cost.

### 3.4 COVERAGE

Users are all expecting to have a great coverage even when they are at home, high speed train or airplane at any time using such 5G technology. Users will not be experiencing problems of high density traffic or in crowded situations.

### **3.5 MOBILITY**

As it has been above-mentioned mobility speed is expected to be 500km/h for overall moving devices such as high speed train/fast vehicles. Moreover, the coverage should remain the same even in remote areas when users move from a place to another place without losing connectivity.

### **3.6 INTERFERENCE**

One of the major issues of the 5G is the interference. It is clear that as the number of transceivers increasing the risk for the interference becomes higher. New use cases and applications will bring more and more transceivers in the 5G technology. Additionally, if there is multiple or simultaneous transceiver communication with full duplex communication, there will be theoretically more interference. However, some solutions are proposed or suggested for the future use. Ericsson suggests a dynamic transmitting so that the transmitter is shut down when there is no transmission and wakes up if there is any transmission [12]. Moreover, dealing with the electromagnetic waves and the way they are transmitted can also make a change in reducing the interference.

## **4. CONCLUSION**

5G is the latest upcoming mobile technology that is expected to be commercialized and deployed by the year 2020. Additionally, so many companies and organization are currently working to build the structure of the 5G network, yet each of them has its vision different than others. So, there is not yet a fixed standard or precise definition for 5G. some major characteristics of 5G technology that will make it to be unique and different than others is its high data rate, low latency and its low power consumption. 5G is bringing into the ground new use cases such as higher user mobility, IoT, extreme real time communications and smart society etc. These uses cases are the demands and needs of the new businesses industry and market and the users usually desire for better technology. This report can be very useful as it contains major topics and chatters regarding the 5G technology from the 5G characteristics or sometimes called requirements to the architecture of the technology. After that, it explains the main functionalities of the 5G in terms of QoS, security and mobility. Finally, challenges or problems facing this new technology are discussed.

## **ACKNOWLEDGMENT**

This work was highly supported and helped by the assistance Prof. Dr. Tara Yahiya. The authors of this paper are greatly appreciating her motivations, aids and comments she has given on the overall report and the area of research of 5G.

## REFERENCES

- [1] M.Cha, (2015, Mar.13), What Is 5G, and What Does It Mean for Consumers? Available: <http://recode.net/2015/03/13/what-is-5g-and-what-does-it-mean-for-consumers/>
- [2] NGMN Lt, "NGMN 5G Initiative White Paper", berkshire,UK: NGMN Ltd,1.0, Feb 2015.
- [3] D.Warren and C.Dewar,"Understanding 5G: Prespectives on future technological advancements in mobile", GSMA intellegence, London,1.0, Feb 2015.
- [4] Nokia Corporation," 5G uses cases and requirments:White paper " Karaportti, Finland:Nokia soulution and Networks, C401-01016-WP-201407-1-EN,2014.
- [5] A. Osseiran, "The 5G Mobile and Wirless Communications System"*in etsi future mobile summit*,2013, pp. 1-18.
- [6] 5G Infrastructure Association expert authors,"The Infrstrcutre Publcı Private Partnership", 5G ppp organisation, Europe, 643973, Feb 2015.
- [7] R. Daws. (2014). We don't know what 5G is, but it's important [Online]. Available:
- [8] <http://www.telecomstechnews.com/news/2014/feb/25/we-dont-know-what-5g-its-very-important-leader-panel-mobile-world-congress-mwc14/> .
- [9] V. Tikhvinskiy. and G. Bochechka, "Prospects and QoS Requirements in 5G Networks",*Journal of Telecommunications and Information Technology*, Moscow,2015, pp.24.
- [10] HUAWEI TECHNOLOGIES CO., LTD., "5G: A Technology Vision", Shenzhen, China: Huawei Industrial Base, M3-023985-20131104-C-1.0,2013.
- [11] D. Waterson. (2015). Security implications of 5G [Online].
- [12] Available: <https://www.linkedin.com/pulse/security-implications-5g-dave-waterson>.
- [13] J. Best. (2015). The race to 5G: Inside the fight for the future of mobile as we know it [Online]. Available:
- [14] <http://www.techrepublic.com/article/does-the-world-really-need-5g/>.
- [15] E.Dahlman, G. Mildh, S. Parkvall, J. Peisa, J. Sach and Y. Selen,"Ericsson review journal", 5G radio access, vol. 91, pp.4, June 2014.

## **Online Social Networks in academia: A Review of Applications and Issues**

Ibrahim AlShourbaji<sup>1</sup>, Samaher Al-Janabi<sup>2</sup>, Wan Khairuzzaman Wan Ismail<sup>3</sup>, Sophia Alim<sup>4</sup>  
and Mohammed Abdelhag<sup>5</sup>

<sup>1</sup>*Computer Network Department, Computer Science and Information System College, Jazan  
University, Jazan 82822-6649, Kingdom of Saudi Arabia*

<sup>2</sup>*Department of Information Network, Faculty of Information Technology,  
University of Babylon, Babylon 00964, Iraq*

<sup>3</sup>*International Business School, Universiti Teknologi Malaysia, Malaysia  
Independent Researcher, UK*

<sup>4</sup>*Department of Information System, College of Computer Science and Information System  
Jazan University, Kingdom of Saudi Arabia*

<sup>1</sup>*alshourbajibrahim@gmail.com*, <sup>2</sup>*samaher@itnet.uobabylon.edu.iq*, <sup>3</sup>*mwkhair@ibs.utm.my*,  
<sup>4</sup>*sophiaalim66@gmail.com*, <sup>5</sup>*mohedtahir@gmail.com*

### **ABSTRACT**

Our society is becoming technology dependent and this is particular true for people in academia. Online Social Network (OSN) is a method to connect students with their teachers within the academic environment. This paper reviews the usage of OSNs, education in other domains, the association between OSNs and learning style as well as its effects in higher education. The review emphasises that OSNs play a vital role in enhancing the effectiveness of teaching and learning process in academia. However, without proper training programs and awareness against OSNs consequences, negative outcomes such as security and privacy issues will occur in academic institutions' IT systems. This affects students and instructors' personal

**Keywords:** Online Social Networks (OSN), Learning style, Academic performance, Applications, Security, Privacy issues.

### **1. INTRODUCTION**

The use of OSN websites is growing especially for academic purposes [1]. OSNs such as Facebook, MySpace and Twitter opens up an enormous opportunity for educational researchers to understand students' learning style, their development as well as improving academic performance [2]. Not only, can an OSN be considered as another medium that universities can use to offer support, but also a place for students to interact with university staff as well as contain information on university resources and culture [3].

The Web 2.0 bandwagon with its improved functionality is the reason OSNs have become popular. Web 2.0 refers to new interoperable, interlocking type of services, where websites would provide components rather than finite, one-stop experiences, to encourage users to interact. Users in this paradigm would be, therefore, free to combine online services in any way they prefer [4]. OSNs refer to a group of Internet-based applications that build on the ideological and technological foundation of Web 2.0. OSNs allow interaction between people to share ideas, audio, videos, and exchange information [5]. OSNs have been considered as a social



technology rather than a formal teaching tool [6] and contribute to higher education to improve student's learning style as well as provide various purposes and potential benefits. It can be considered as a learning tool to provide a dynamic virtual world between students and instructors [7].

It can be also used to enhance the communication and to share information between students and instructors by accessing various contents and information from anywhere at any time [8]. Therefore, educational institutions can easily reach conceptive students according to their interests and availability online. Availability of OSNs can motivate students to share their ideas and thoughts. They can discuss technical issues inside or outside university. This has encouraged universities to further explore the use and effectiveness of OSN as a teaching tool. However, this could increase the chance of accessing personal and private data that includes student identifiers. This can lead to identity misuse and could be the primary reason for targeting academic institutions by attackers [9].

This study was motivated to provide a comprehensive overview of the usage of OSN in the context of learning style and their effects in higher education institutions. In addition to this, identifying areas that need further research in the academic sector to improve the awareness against the use of OSN in academia, in an attempt to reduce the damage that could be incurred now and in the future from cyberattacks. Our research is based on answering the following questions:

- What is the role that OSNs can play in learning style for students and how does this affect academic staff?
- What effects do OSNs have in regards to education in other domains?
- What are the issues in sharing different types of contents and private information on OSNs?
- What are the criteria needed to increase the awareness level and qualify trustworthy in academic sector?

The remainder of the paper is structured as follows: Section 2 provides literature review for OSNs which covers areas such as OSN usage, the application of OSNs in different domains as well as the issue of information disclosure. The discussion of the paper is provided in Section 3 and the paper is concluded in Section 4.

## **2. LITERATURE REVIEW**

### **2.1 OSN USAGE AND LEARNING STYLES**

The usage of the OSN has changed the way people live and work and it has become a necessary need in our daily life including entertainment, professional networking and to communicate with those close to us. This plays a vital role in increasing the risk of theft, fraud and abuse of personal data. On the other hand, there is no country, industry or even individual that is safe from cyber security incidents risks and its negative consequences. In the light of this, security awareness is particularly important for sensitive information that must be protected at all times from cyber-attacks.

The security of information systems is becoming a leading priority, where the number of cyber security incidents rapidly rises and became more and more effective and aggressive than before. According to a report in 2013, by the Kaspersky Lab, about 91% of the organizations surveys reported that their IT Infrastructure had been the target of at least one external attack in the past 12 months. They also reported that malware, spam, phishing, network intrusion and the theft of mobile devices increased significantly compared to 2012 for these five

threats. For that, each organization using information systems must take information security seriously as a top priority. Awareness against OSNs consequences has not to be ignored and it is important to all information security aspects.

There are hundreds of millions of users use OSNs. They are available, free, are engaging and are fun to use. This makes them appropriate to be utilized for teaching and learning, particularly towards enhancing social interactions [10, 11]. A number of researchers have examined the relationship between the learning style and the usage of OSNs. This can help instructors and students to effectively communicate and enhance the teaching and learning process in the academic sector [12, 13, 14, 15]. OSNs could also be utilized to upgrade the general knowledge of students and instructors. They can exploit the learning functions provided by OSNs, which can provide and facilitate gathering information in any place and anytime. It empowers students to take classes whenever it seems best. The students also have complete freedom of area and time. Since they can access the data online, they can refer to the important information fast, which enhances their effectiveness, motivation and interaction in the learning process. The integration of OSNs and the online environment can be beneficial for the students for learning purposes and the student learning style will be enhanced [15, 16]. Much research has been conducted in this area, most of which shows that the use of OSNs can have a positive impact on the learning environment. With the technology, universities and educators can spread the information online and students can access it more easily. Hamid et al. [12] explored the use of social technologies for supporting the interactions between students and their instructors across two universities in Malaysia and Australia. The results revealed that students identified a number of positive results from using OSNs to enhance their interaction among themselves and with their instructors, and OSNs would be useful in providing richer insights when they use it for educational aims. In another study, [14] measured the impact of OSNs usage compared with the usage of traditional learning management system (LMS). They looked into how individuals interact and learn within OSNs using a theoretical model of student learning, course community and social interaction before and after the intervention. The results showed that students experienced higher levels of perceived social interaction and the course community had higher levels of satisfaction with OSNs when compared to using LMS. The results also confirmed that OSNs yielded a higher number of interactions, providing a more engaging learning experience.

## **2.2 OSNS IN DIFFERENT DOMAINS**

Much research has been conducted to study the impact of OSNs in various domains [17, 18, 19, 20, 21]. The authors in [19] Investigated if online writing affects students writing anxiety and to access overall students' attitudes towards the use of Facebook in the academic domain using quantitative study and based on Vygotsky's learning theory and Technological Pedagogical Content Knowledge (TPACK) model. The findings showed that there is a positive association between writing online via the use of Facebook and reducing anxiety levels and those educators also should embrace the use of OSNs in classrooms.

The authors in [18] studied the impact relationship between OSNs and consumer brand using a quantitative method to test the hypothesized relationships. The findings showed that a general support for the positive effect of Brand's Social Network (BSN) benefits on outcome variables. The study also concluded that BSN positively influence consumer's perception of relationship investment made by the

brand, resulting in both brand relationship quality and the willingness to spread good words about the BSN. In [20], the authors investigated whether nurses used social media as effective educational tools to support their study using Facebook and the findings revealed that OSNs have the potential to enhance students' self-efficacy in learning and can deeply support and develop their learning. On the other hand, research conducted by [22] used a series of univariate ANOVAs and regressions to investigate how different aged individuals use Facebook. The findings showed that there are significant differences in using of OSNs between older adults' and younger generation. In addition, there is a need for further investigation into the effects of OSNs on individuals of different age groups. Game-based learning (GBL) refers to the use of computer games that possess educational value or different kind of software applications that use games for learning, training and education purposes. It is widely used in different domains including military, education, marketing and advertising. Despite its admiration, an assessment of OSNs and its efficiency as a learning tool is still vague. A conceptual analysis framework is proposed by [23] in an attempt to evaluate the effectiveness of using GBL in academic domain and the findings showed that the learner's background influenced learner's motivation to learn, and therefore, affected their performance. The authors in [24] examined the association between OSNs parameters and student outcomes. They suggested that the researchers should further investigate, whether there are conditions under which social network parameters are reliable predictors of academic performance. They also advise against relying completely on social network parameters for predictive purposes. On the other hand, [26] presented a novel cloud-computing-based service, which relies on advanced artificial intelligence technique to infer knowledge and interest from users in different OSNs. This way enables the authors to have a better way to look at a certain degree of the user's knowledge level on different topics. Limongelli et al., [25] defined a model, which aims to give teachers a personalized support, encompassing consideration for their own teaching styles, and teaching experience issues during course construction. It is vitally important to consider all of these issues in a dynamic way towards the best moral choices for the instructors and subsequently improve their students' performance.

## **2.3 INFORMATION DISCLOSURE**

The number of OSNs users has dramatically increased in recent years and these technologies became increasingly necessary in our daily life activities. For example, hundreds of millions of users post terabytes of data on several OSNs websites every day [27]. OSNs services allow their users to share different types of private contents and information such as, photos, videos, age and gender, contacts and interests. In addition to this, they can play a vital role in maintaining friend relationships and finding support and information. Information disclosure refers to which one allow access to aspects of one's private information, in the case of unauthorized access or use in unethical manner to this private information without user's consent could lead to negative consequences such as privacy violation and identity theft [28]. For this, more attention should be given to privacy issues in OSNs including who would have the right to access these private information and profiles and how the profile data would be retrieved, stored, controlled and distributed. A worldwide range of studies has focused on the importance of private information disclosure on OSNs. In [29], the authors investigated the impact privacy concerns among college students for both men and women. The findings show that men have higher percentage of women to

privacy concern and information disclosure. This also confirmed by the study conducted [30]. The authors in [31] examined the several factors associated with the probability of increased concerns over privacy in 26 Europe countries, their findings show that the cultural and socio-demographic are the main factors that can affect the level of privacy concerns. In another study conducted by [32] showed that there is an urgent need for privacy on OSNs and it is one of the most crucial issues in both industries and academic sector. They investigated the effects of several factors such as user's demographics, personal social network size, blogging productivity and social network site experience on privacy disclosure. Their findings showed that social network site experience and personal social network size are not significantly related to user's privacy disclosure and blog number has positive relations with privacy disclosure patterns.

## **2.4 THE EFFECTS OF OSN USAGE**

Despite the fact OSNs bring benefits to many people and organizations. For instance, educational institutions can use OSNs to provide their students with different information; examples include, the university news, activities, emails, courses; academic year calendar, academic staff, student's marks and other personal information stored on their computer systems. Therefore, these systems need to be protected against a number of threats such as spyware, cross-site scripting (XSS), viruses, worms, Trojan horse, phishing, Denial-of-Service (DoS), and Distributed Denial-of-Service [33]. It could be used by an adversary not only to effect on the organization's assets by stealing their sensitive information, but also could effect on the organization's financial side. Therefore, every organization using information systems must take information security seriously.

Many studies have shown that the use of OSNs could have an adverse effect on certain locations. For example, spending long time on using OSN at improper times inside the classroom or while studying time has a significant effect on academic performance and may lead to other problems, such as emotional stress, damaged relationships and attention deficit disorder. Another negative consequence is a phenomenon [34]. This phenomenon indicates how people keep thinking and checking their OSN websites even when they do not need to use it.

Another concern for students is cyber bullying. It is the act of bullying a person using electronic communication tools by sending threatening messages such as, viruses or malware to hurt a person through social media websites, chat and emails [35]. A survey of 430 students from Greek universities by [36], they found that more than half (58.4%) of the respondents had participated in cyber bullying and it is becoming more common.

There are also many studies have investigated the relationship between the usage, multitasking of OSNs and students' Grade Point Average (GPA) [37, 33, 38, 39, 38, 40]. The findings showed that the students who spend fewer hours per week in studying achieve lower GPA than others. This is also confirmed by the study conducted by [40]. Similarly, the authors in [39] conducted a survey of university students in Saudi Arabia in an attempt to investigate not only the relationship between the usage of social media and their academic performance but also to specify the most popular social media preferred by the students. The results, however, demonstrated that the relationship between social media usage and GPA score does not exist. Students highlighted that besides social media use; time management is a factor, which affects their studies negatively.

On the other hand, [38] investigated multitasking with technologies on the relationship between the use of OSNs and students GPA. The study showed, decreasing in both the efficacy and productivity in academic setting and their GPA. This is also confirmed by [41]. In [42] the authors investigated the relationship between Facebook activities, use, time spent on preparing classes and GPA. The findings show that a strong negative association between times spent on Facebook and the overall GPA and a weak relationship between times spent on using Facebook and preparing of class material. Other studies have focused on the effects of OSNs on personality [43, 48, 44, 45]. The primary goal of the study by [46] was to investigate the effects of OSNs usage, specifically Facebook on the users and their behavior. The findings revealed that the educational use of Facebook is explained directly by its purposes of usage and indirectly by its adoption. There is a relationship between both personality behavior and Facebook usage. [44] confirm that there is a strong relationship between Facebook user's photo-related activities and personality traits. In another study conducted by [45], the results disclosed that shyness, motivation and self-efficiency attitudes and sociability have positively related to OSNs use. In a study reported by [47], it was found that OSNs could be used as a support tool for users in their Decision Making (DM) process specifically in three phases including intelligence, design and choice. First intelligence is to collect information about a problem and identifies its consequences. Second is to understand the problem from different sides. In the last phase is the attempt to find out alternatives that can lead to the best decision option. The results also revealed that various types of users have meaningfully different participation styles, which in turn have impact on the effectiveness of the DM process

### **3. DISCUSSION**

OSN networks play a significant role in every aspect of our lives, both personal and public communication. People rely on OSNs to provide them with news, post information, share photos and other personal information. These technologies have also changed the way people live and interact. By adapting OSNs especially in the higher institutions, not only learning can happen whenever and at wherever but also it can enhance the student-student and student-instructor interactions.

Not only OSNs provide both students and teachers access to unlimited amounts of information to expand their learning and knowledge prospects, but also they play a role in increasing their dynamic educational experiences. OSNs can also be used as a channel for communication. They enable collaborative learning within students where a group of students is given a problem statement and each of them is expected to reach a consensus to submit a single answer or to write a new answer collectively.

However, the access to this unlimited information by different parties may pose to different types of risk and this information needs to be protected from intruders danger when it is transferred and it should remain safely stored and the only users who have the authority can regulate the collection and use that private information. For this, a high level of system security is required to protect users' records. Information Security Management System (ISMS) can play a vital role in improving and managing information security aspects, where its main goal is to identify approaches, strategic decisions, and methodologies to ensure that the data is kept safe from risks and threats. ISMS can also be a very useful tool to bridge the gap between management and technical people were both parties have to understand that security is not something that could be ignored and it is one of the most important

factors to achieve the desired goals in any organization. It is vitally recommended that academic institutions implement an ISMS in their environment to ensure that the data of students, academic staff, and employees are kept safe. Furthermore, by implementing ISO/IEC 27001: 2013 which represents one of the most widely used standards, academic institutions can ensure that the security of their private data are secured at all levels as well as improve the effectiveness of their information security. Aside from privacy concerns, awareness is also an important issue to be considered in OSNs. This is because some of end-users are ignorant of this type of technology and their consequences, and therefore, they are unable to make balanced judgments concerning the level to which it may have a negative impact on their own perceived standards of privacy. In order to address and mitigate this issue, First, cyber security awareness should undergo meticulous designing and formulation by the academic institution at the enterprise level of top management as the highest authority responsible for all kinds of security affecting its users, students, academic staff, and employees. These policies should then be carried through and executed at all level of management to ensure protection and compliance. Second, the awareness should start from academic staff to students by teaching about cyber incidents consequences and risks of OSNs within workshops, classrooms. Teachers should also educate what is new in this field and in this way we will ensure a clear picture of awareness level at the individual and institutional level. Third, is to encourage the active use of privacy services and facilities within OSN websites. Finally, it will also require actual and non-actual regulatory and standards bodies, governments, higher education to address the safety measures' issues to synthesize legislations, directives and guidelines for the use of OSNs in academic sectors as part of their comprehensive deployment strategy.

#### **4. CONCLUSION**

OSNs bring some benefits to people and have effect on academic performance, decision-making ability and personality. OSNs enable their users to share different types of private contents. This information needs to be away from risks, it is vitally important to focus on the security and privacy issues in OSN to protect these contents to be away from risks. This would also require awareness framework to meet the need for the other substantive safety measures to ensure compliance with the law and ethical behavior by students, instructors and academic institutions to safeguard their personal and information data now and in the future. OSNs technology has changed the traditional idea and way of learning, in that we are continually surrounded in learning encounters. In this period of advancement, we have a propensity to effortlessly adjust to the innovations and teaching methods that develop. Therefore, the combination of OSNs and learning may offer great advancement in the conveyance of teaching in the future. It can be concluded that OSNs can play a vital role in enhancing the effectiveness of teaching and learning process in academia. This study may assist to be as a database for different researchers who aim to examine the usage of OSNs and their issues in academia.

#### **REFERENCES**

- [1] C.M Cheung., P.Y. Chiu and M.K. Lee, "Online social networks: Why do students use facebook?", *Computers in Human Behavior*, vol. 27, pp. 1337-1343. 2011.

- [2] R. Arteaga Sánchez, V. Cortijo and U. Javed, "Students' perceptions of Facebook for academic purposes," *Computers & Education*, vol. 70, pp. 138-149. 2014.
- [3] A. Y. Yu, S. W. Tian, D. Vogel and R. C. W Kwok, "Can learning be virtually boosted? An investigation of online social networking impacts," *Computers & Education*, vol. 55, pp. 1494-1503. 2010.
- [4] S. Bennett, A. Bishop, B. Dalgarno, J. Waycott and G. Kennedy, "Implementing Web 2.0 technologies in higher education: A collective case study," *Computers & Education*, vol. 59, pp. 524-534. 2012.
- [5] W. H. D. Huang, D. W. Hood and S. J. Yoo, "Gender divide and acceptance of collaborative Web 2.0 applications for learning in higher education," *The Internet and Higher Education*, vol. 16, pp. 57-65. 2013.
- [6] R. Junco, "The relationship between frequency of Facebook use, participation in Facebook activities, and student engagement," *Computers & Education*, vol. 58, pp. 162-171. 2012.
- [7] K. F. Hew, "Students' and teachers' use of Facebook," *Computers in Human Behavior*, vol. 27, pp. 662-676. 2011.
- [8] I. Buzov, "Social Network Sites as Area for Students' Pro-environmental Activities," *Procedia-Social and Behavioral Sciences*, vol. 152, pp. 1233-1236. 2014.
- [9] M. Kaplan Andreas, M. Haenlein, "Users of the world, unite! The challenges and opportunities of social media," *Business Horizons* vol. 53, pp. 61. 2010.
- [10] N. H. M. Alwi, N. A. Mahir and S. Ismail, "Infusing Social Media in Teaching and Learning (TnL) at Tertiary Institutions: A Case of Effective Communication in Universiti Sains Islam Malaysia (USIM)", *Procedia-Social and Behavioral Sciences*, vol. 155, pp. 265-270. 2014.
- [11] R. Ventura and M.J. Quero, "Using Facebook in University Teaching: A Practical Case Study," *Procedia-Social and Behavioral Sciences*, vol. 83, pp. 1032-1038. 2013.
- [12] S. Hamid, J. Waycott, S. Kurnia, and S. Chang, "Understanding students' perceptions of the benefits of online social networking use for teaching and learning," *The Internet and Higher Education*, vol. 26, pp. 1-9. 2015.
- [13] L. A. Wankel and P. Blessinger, "New Vistas in Higher Education: An Introduction to Using Social Technologies," *Cutting-edge Technologies in Higher Education*, vol. 6, pp. 3-16. 2012.
- [14] B. Thoms and E. Eryilmaz, "How media choice affects learner interactions in distance learning classes," *Computers & Education*, vol. 75, pp. 112-126. 2014.
- [15] S. Wanpen, "The Relationship between Learning Styles and the Social Network Use of Tertiary Level Students," *Procedia-Social and Behavioral Sciences*, vol. 88, pp. 334-338. 2013.
- [16] R. R. V. Rasiah, "Transformative higher education teaching and learning: Using social media in a team-based learning environment," *Procedia-Social and Behavioral Sciences*, vol. 123, pp. 369-379. 2014.
- [17] A. A. Barreda, A. Bilgihan, K. Nusair and F. Okumus, "Generating brand awareness in Online Social Networks," *Computers in Human Behavior*, vol. 50, pp. 600-609, 2015.
- [18] H. Park, and Y. K Kim, "The role of social network websites in the consumer-brand relationship," *Journal of Retailing and Consumer Services*, vol. 21, 460-467. 2014.

- [19] P. Ponnudurai, and T. T. Jacob, "Facebook: A Shift from Social to Academia," *Procedia-Social and Behavioral Sciences*, vol. 123, pp.122-129. 2014.
- [20] M. Tower, S. Latimer and J. Hewitt, "Social networking as a learning tool: Nursing students' perception of efficacy," *Nurse Education Today*, vol. 34, pp. 1012-1017. 2014.
- [21] M. Michikyan, K. Subrahmanyam, and J. Dennis, "Facebook use and academic performance among college students: A mixed-methods study with a multi-ethnic sample," *Computers in Human Behavior*, vol. 45, pp. 265-272. 2015.
- [22] M. Hayes, K. van Stolk-Cooke and F. Muench, "Understanding Facebook use and the psychological effects of use across generations," *Computers in Human Behavior*, vol. 49, pp. 507-511.2015.
- [23] M. M. Ariffin, A. Oxley and S. Sulaiman, "Evaluating Game-Based Learning Effectiveness in Higher Education," *Procedia-Social and Behavioral Sciences*, vol. 123, pp. 20-27. 2014.
- [24] A. Hernández-García, I. González-González, A. I. Jiménez-Zarco and J. Chaparro-Peláez, "Applying social learning analytics to message boards in online distance learning: A case study," *Computers in Human Behavior* , vol. 47, pp. 68-80. 2014.
- [25] C. Limongelli, F. Sciarrone, M. Temperini, "A social network-based teacher model to support course construction", *Computers in Human Behavior*, vol. 51, pp. 1077-1085, 2015.
- [26] V. Stantchev, L. Prieto-González and G. Tamm, "Cloud computing service for knowledge assesOSNent and studies recommendation in crowdsourcing and collaborative learning environments based on social network analysis", *Computers in Human Behavior*, vol. 51, pp. 762-770, 2015.
- [27] E. Litt, "Understanding social network site users' privacy tool use", *Computers in Human Behavior*, vol. 29, pp.1649-1656. 2013.
- [28] A. Nosko, E. Wood and S. Molema, "All about me: Disclosure in online social networking profiles: The case of FACEBOOK," *Computers in Human Behavior*, vol. 26, pp. 406-418. 2010.
- [29] J. Fogel and E. Nehmad, "Internet social network communities: Risk taking, trust, and privacy concerns," *Computers in human behavior*, vol. 25, pp.153-160. 2009.
- [30] [30] V. Kisekka, S. Bagchi-Sen and H. R. Rao, "Extent of private information disclosure on online social networks: An exploration of Facebook mobile phone users" *Computers in Human Behavior*, vol. 29, pp. 2722-2729. 2013.
- [31] G. Cecere, F. Le Guel and N. Soulié, "Perceived internet privacy concerns on social networks in Europe," *Technological Forecasting and Social Change*. vol 96, pp. 277-287, 2015.
- [32] K. Li, Z. Lin and X. Wang, "An empirical analysis of users' privacy disclosure behaviors on social network sites," *Information & Management*, vol. 52, pp. 882-891. 2015.
- [33] J. A. Paul, H. M. Baker and J. D. Cochran, "Effect of online social networking on student academic performance," *Computers in Human Behavior.*, vol. 28, pp. 2117-2127. 2012.
- [34] J. Heidemann, M. Klier and F. Probst, "Online social networks: A survey of a global phenomenon," *Computer Networks*, vol. 56, pp. 3866-3878. 2012.



- [35] R. Dredge, J. Gleeson and X. de la Piedad Garcia, "Cyber bullying in social networking sites: An adolescent victim's perspective," *Computers in Human Behavior*, vol. 36, pp. 13-20. 2014.
- [36] C. M. Kokkinos, N. Antoniadou and A. Markos, "Cyber-bullying: An investigation of the psychological profile of university student participants," *Journal of Applied Developmental Psychology*, vol. 35, pp. 204-214. 2014.
- [37] P. A. Kirschner and A. C. Karpinski, "Facebook and academic performance," *Computers in Human Behavior*, vol. 26, 1237-1245. 2010.
- [38] A. C. Karpinski, P. A. Kirschner, I. Ozer, J. A. Mellott and P. Ochwo, "An exploration of social networking site use, multitasking, and academic performance among United States and European university students," *Computers in Human Behavior*, vol. 29, pp. 1182-1192. 2013.
- [39] E. Alwagait, B. Shahzad and S. Alim, "Impact of social media usage on students' academic performance in Saudi Arabia", *Computers in Human Behavior*, vol. 51, pp. 1092-1097, 2014.
- [40] S. Ainin, M. M. Naqshbandi, S. Mogavvemi and N. I. Jaafar, "Facebook usage, socialization and academic performance". *Computers & Education*, vol. 83, pp. 64-73. 2015.
- [41] R. Junco, "Student class standing, Facebook use, and academic performance," *Journal of Applied Developmental Psychology*, vol. 36, pp.18-29. 2015.
- [42] R. Junco, "Too much face and not enough books: The relationship between multiple indices of Facebook use and academic performance" *Computers in Human Behavior*, vol. 28, pp. 187-198. 2012.
- [43] B. Zhong, M. Hardin and T. Sun, "Less effortful thinking leads to more social networking? The associations between the use of social network sites and personality traits," *Computers in Human Behavior*, vol. 27, pp. 1265-1271. 2011.
- [44] A. Eftekhari, C. Fullwood and N. Morris, "Capturing personality from Facebook photos and photo-related activities: How much exposure do you need," *Computers in Human Behavior*, vol. 37, pp. 162-170. 2014.
- [45] J. L. Wang, L. A. Jackson, H. Z. Wang and J. Gaskin, "Predicting Social Networking Site (SNS) use: Personality, attitudes, motivation and Internet self-efficacy," *Personality and Individual Differences*, vol. 80, pp. 119-124. 2015.
- [46] Y. Amichai-Hamburger G. Vinitzky, "Social network use and personality," *Computers in Human Behavior*, vol. 26, pp. 1289-1295. 2010.
- [47] V. Sadovykh, D. Sundaram and S. Piramuthu, "Do online social networks support decision-making," *Decision Support Systems*, vol. 70, pp.15-30. 2015.
- [48] P. A. Gloor, K. Fischbach, H. Fuehres, C. Lassenius, T. Niinimäki, D.O. Olguin and J. Putzke, "Towards Honest Signals of Creativity—Identifying Personality Characteristics Through Microscopic Social Network Analysis," *Procedia-Social and Behavioral Sciences*, vol. 26, pp. 166-179. 2011.

## **RESIDENTIAL BUILDING DEVELOPMENT PROCESS IN KURDISTAN REGION GOVERNMENT**

Haval Mohammed Salih

*Department of Civil Engineering, Ishik University, Erbil, KRG-Iraq  
haval.civil@yahoo.com*

### **ABSTRACT**

Nowadays, Residential buildings have become the most important part of real-estate markets in (KRG). The layout of housing in Kurdistan has transformed the face of major cities across the Region. Rapid changes since 2003, have witnessed copious architectural structures and large housing projects that have reshaped the landscape of its cities. The aim of this study is to study the housing developing policy in KRG. The objectives of the study are to evaluate the KRG's housing development policy and to investigate the types of house and the price range preferred by the potential buyer. The study focus on private residential building development projects and it is carried out by questionnaires and interviews. The respondents are the house buyers and the developers. A total of 100 questionnaires were distributed to the respondents and 78 questionnaires were returned duly answered. The data collected is analyzed using the SPSS (Statistical Package for the Social Sciences) and Average Index. The results of research indicated that the KRG's housing development policy covers the ownership of the project land, full repatriation of project investment and profits allowed, import of spare parts tax exempt up to 15% of project cost and the employment of foreign workers allowed. Moreover, the types of house preferred by the house buyers are of double storey type and to be of corner lot. The price range preferred by the potential buyers are between (40,000 to 100,000) USD.

**Keywords:** Residential building, Types of House, Housing Development Policy, Housing Price.

### **1. INTRODUCTION**

For many people a house is more than a building. Our homes are unique places where stories and memories are originated, and where we seek protection from the world around us and solace at the close of an eventful day. Most families in the developing countries are lacking proper housing facilities. Hence, it is imperative for the governments to get involved in the construction of housing for their citizens [1]. The government of Malaysia recognizes housing as a basic human need and an important component of the economy [2].

Housing Development implies the construction or initiation of constructing housing accommodation exceeding four units. It involves charges of fees and executing building operations with the aim of erecting housing accommodation in, on, over or under any land; or the selling of units of housing lots exceeding four units by the landowner or his agent with the aim of constructing more than four units of housing accommodation by the said landowner or his agent. The Kurdistan region of Iraq has a steady security condition for its operations. The region when compared to other regions in Iraq is acclaimed to be the secured region in the country. Up till

now, there is no attacks in the region. Based on its safety, the serene security condition catalysed a positive impact on the local community and has enabled the restoration of Kurdistan natural environment and has aided the development of its economy. This stability is important to foreign investors in the region and they are convinced of safety of their investments. This security and safety is an illusion in the remaining parts of Iraq and this has prevented investments in those places.

## **2. PROBLEM STATEMENT**

Residential house development consist of public and private sectors. There are a lot of developers nowadays, who invest in private sectors in KRG. There are many complexes in KRG which are called village and city, each village or city contains of hundreds of houses plus commercial, hospital, schools and so on, some of them finished while most of them still not finished, under construction. Eventually, this study focus on the complexes in Erbil.

Housing has been crucial issue in KRG since 2003. Accordingly, the Ministry of Planning has a strategic development plan for 2012-2016 which stresses to increase grants of land and housing by 20% per year. The buyer has two choices; buying a house from a developer or build themselves. Also, a new real-estate law has been established in the KRG, Advances of Real Estate. A KRG's citizen has the right to get a determinate of money and it pay back in the following twenty years without interest [3]. This reason alone, is a great way to encourage people to build themselves.

### **2.1 AIM AND OBJECTIVE:**

The aim of this study is to assess the housing development policy and the problems faced by the housing developers in KRG. The objectives of the study are as follows:

- To study the KRG's housing development policy.
- To evaluate the types of house and the price range preferred by the potential buyer.
- To recommend the reasonable recommendation for the government and developers.

### **2.2 SCOPE**

The study is carried out in the KRG. The researcher focus on private residential building development projects in KRG and additionally, it stresses the types of houses preferred by buyers. The study is carried out based on data collected from the questionnaires.

### **3. LITERATURE REVIEW**

#### **3.1 USER SATISFACTION AND BUILDING PERFORMANCE EVALUATION**

Satisfaction studies spans a variety of disciplines in the social science, management and the built environment. In general, satisfaction is a subjective investigation of the accomplishment of products or services in meeting the needs and expectations of users or customers [4].

Buildings are similar to other merchandise, they are designed and constructed with lots of expectations from users, professionals, the community and clients. For clients, buildings need a significant capital financing and are expected to yield profits on investment, for professionals (e.g. engineers, builders and architects buildings are outcome of their ingenuity and imaginative thinking. On the part of the community and users, a key expectation is that buildings will satisfy their needs and expectations by supporting their daily chores [5] and finally enhance the aesthetic quality of the built environment. To this end, van der Voordt and Maarleveld [6] observed that building performance evaluation (BPE) assesses the economic value, technical, functional and architectural value of buildings (product evaluation) or building procurement process (process evaluation). By identifying the main limitation and strengths of buildings from the view of end users. [7], BPE enhances the quality of buildings and Performance evaluation of residential buildings in public housing estates in Ogun State, Nigeria. Elsewhere in Malaysia, the study by [7; 8] established that occupants' satisfaction is highly associated with the performance of public buildings; meaning that user satisfaction has a direct relationship with the overall performance of buildings in meeting the needs and expectations of the users [9].

#### **3.2 CUSTOMER SATISFACTION**

Customer satisfaction is a significant method of obtaining competitive advantage in the market place [10; 11; 12] For example customer satisfaction has been found to increase market share, enhance profitability, raise repeat sales [13] and enhance word-of mouth endorsement. Indeed, countries like Sweden utilise it as an avenue to determine national competitiveness [14]. In the light of the above, it is not amazing that customer satisfaction features prominently in modern business management philosophies.

In construction, the concept of customer satisfaction has gradually been elevated in importance. For instance the 'Latham report' identified the customer as being at the centre of the construction process [15]. The 'Egan report' was more detail on the difference between large public sector clients and small inexperienced clients, each needed varying levels of leadership, design input and supply chain systems [16]. In recent time, an international construction symposium aimed at customer satisfaction as the spotlight for future research in the construction sector [17]. These signs suggest that the construction industry is starting to increase the recognition of customer satisfaction as a tool of attaining competitive advantage in the market place [8].

### **3.3 VARIATION IN HOUSING DESIGN: IDENTIFYING CUSTOMER PREFERENCES**

Companies are being mandated to act in response to the rising individualization of demand. Previous studies argued that if companies hope to fulfill customers' needs better than their competitors, they should present diversified products [18; 19; 20]. In the housing industry there is an increasing customer demand for variety. Recent research about construction firms in countries such as the Netherlands [21], Great Britain [22; 23], the USA [24], and Japan [25; 26; 27], and revealed that many firms are investigating methods of achieving greater levels of custom-made housing design. The objective is to maintain a stable price at an acceptable level without compromising the advantages of serial, project based production [28]. To achieve the required customisation at reasonable cost, it is relevant to understand how customers prioritise the different elements such as bathroom, kitchen and roof type of a house design.

### **3.4 HOUSING ATTRIBUTES**

Housing attributes have been shown in many studies to range from to neighborhood and locational indicators, such as environmental qualities [29; 30] extrinsic attributes, such as exterior design and exterior space, to intrinsic housing attributes such as interior living spaces. In respect to the locational attributes of housing [31], distance to the workplace, schools, retailing outlets and public transportation stations have been identified as important significant considerations for house buying. Wang and Li [30] stated that purchasing a house is a multifaceted task, involving, for example tenure options, housing types, neighborhoods and locations, as future housing preferences will thereafter be determined by a set of various attributes.

### **3.5 SUMMARY OF INVESTMENT LAW (WHICH IS ALSO APPLIED FOR RESIDENTIAL HOUSING PROJECTS):**

- Total ownership of project land allowed, though investor may not own land containing oil, gas or mineral resources.
- Does not explicitly prohibit investment in these areas, but Supreme Council for Investments may allow investment in any sector it chooses other than those explicitly listed in the law's categories (e.g. hotels, transportation, services).
- Full repatriation of project investment and profits allowed. Project income tax exempt for ten years from date production commences or offer of services; no provision for extension of income tax exemption.
- Import of spare parts tax exempt up to 15% of project cost.
- Hotels, hospitals, universities, schools, tourist institutions granted tax-exempt import of linens, carpets, furniture and other renovation items every three years.
- Employment of foreign workers allowed, provided no capable Iraqis available; foreign workers may repatriate earnings.
- Vehicles, equipment, instruments, etc. tax exemption from duties, taxes and import licenses, provided they are imported within two years of approval granted by Investment Commission Chairman.

- Foreign investor and capital treated on equal footing with national investor and capital.
- KRG will provide services (water, electricity, sewage, public road, telecommunications, etc.) to the boundary of the project.
- Import of raw materials for production tax exempt for customs duties for five years.
- Additional incentives for projects in “less developed areas” and “joint projects” between Kurds and foreigners. Foreign and/or domestic insurance of project allowed.
- Supremacy of Kurdistan Law (Art. 115 of Iraq’s Constitution): “If there is any contradiction (between this law and “other relevant laws”), the provision of this law shall be applicable.” (32)

#### 4. RESEARCH METHODOLOGY

##### 4.1 DATA COLLECTION

The data is collected by using online questionnaire. The respondents are the clients, contractors, project managers, office engineers, Site engineers and supervisor engineers.

##### 4.2 AVERAGE INDEX

The data was studied and analyzed using SPSS. The analysis of the data from the received feedback from the questionnaire using SPSS gives average index calculation. This index was calculated as follows [33], (See Table 1)

$$\text{Average Index (AI)} = (\sum \mu X n) / N \quad (1)$$

Where,  $\mu$  is Weighting given to each factor by respondents (1 to 5); n is Frequency of the respondents; and N is Total number of respondents.

TABLE 1.  
Rating scale of average index

Average Index	Rating scale
$1.00 \leq \text{Average Index} < 1.50$	Strongly Disagree
$1.50 \leq \text{Average Index} < 2.50$	Disagree
$2.50 \leq \text{Average Index} < 3.50$	Undecided / Neutral
$3.50 \leq \text{Average Index} < 4.50$	Agree
$4.50 \leq \text{Average Index} \leq 5.0$	Strongly Agree

#### 5. RESULTS AND DISCUSSION

This study focuses on the evaluation of types and price of house preferred by the buyers and identify the problems faced the housing developers in Erbil city, KRG, therefore the following results were found in relation to the selected objectives for the study.

Cronbach's alpha is the most common measure of internal consistency ("reliability"). It is most commonly used when you have multiple Likert questions in a survey/questionnaire that form a scale and you wish to determine if the scale is reliable. The alpha coefficient for the 43 items is 0.995, suggesting that the items have relatively high internal consistency. (Note that a reliability coefficient of .70 or higher is considered "acceptable" in most social science research [34], (See Table 2).

TABLE 2.  
Reliability statistics

Cronbach's Alpha	Cronbach's Alpha Based on Standardized Items	N of Items
0.995	0.995	43

## 5.1 QUESTIONNAIRE SURVEY

Questionnaire was design online and the data collected were analyzed to evaluate the types and price of house preferred by the buyers and to achieves the objectives that mentioned previously.

Table (3) shows the degree of respondents, Bachelor has the biggest portions of the table with 60.26 %. While the master is almost half of bachelor with 34.62% of total number of participants. However, PhD comprise 2.56% of respondents. In contrast, high school and Diploma has the smallest percentages with only 1.28%.

TABLE 3.  
Respondents' degree

Degree	Frequency	Percentage %
High School	1	1.28
Diploma	1	1.28
Bachelor	47	60.26
Master	27	34.62
Phd	2	2.56
Total	78	100%

Below table describes the profession of respondents, it can be seen that the most of the participants (36%) were supervisor Engineer. Likely, 28% of them were Site Engineer. While, Project Manager and Office Engineer together make up the same portion of site engineer. Finally, Contractor and Client comprise the smallest portion of Pie chart with 5% and 3%, respectively.

TABLE 4.  
Respondents' profession

Profession	Frequency	Percentage %
Site Engineer	22	28%
Supervisor Engineer	28	36%
Office Engineer	11	14%
Project Manager	11	14%
Contractor	4	5%
Client	2	3%
Total	78	100%

As it has been shown in table (5), it is very important that the majority of respondents have more experience in order to make the data more accurate. It can be seen from below table that 42% of them have experience of (4-8) years, 35% less than 4 years, 17% for 8 – 12 years and 6% over 15 years. It can be concluded that majority of the respondent working experience ranges between 4 – 8years.

TABLE 5.  
Respondents' year of experience

Year of experience	Frequency	Percentage %
Less than 4 years	27	35%
4-8 years	33	42%
8-12 years	13	17%
more than 15 years	5	6%
Total	78	100%

## 5.2 TO EVALUATE THE TYPE OF HOUSE AND THE PRICE RANGE PREFERRED BY THE POTENTIAL BUYER.

Table (6) shows the price category that preferred by potential buyer to buy from developers. As it has been shown that 36% of them would like to buy for (40000–60000) USD. Similarly, 37% of them preferred to buy for (90000-150000) USD. In contrast, the smallest number of respondents with only 3% want to buy for more than 150000 USD.

TABLE 6.  
Price category of houses preferred by buyers

Price category (USD)	Frequency	Percentage %
less than 30000	4	5%
30000 - 40000	15	19%
40000 - 60000	28	36%
90000 - 150000	29	37%
more than 15 0000	2	3%
Total	78	100%

As it has been described in table (7), the majority of people in KRG would like to have double storey house with 80%. Unlikely, only one fourth of that number prefers single story house with 20%. However, no one would like to buy triple storey house.

TABLE 7.  
Level of house preferred by buyers

Type of house	Frequency	Percentage %
Single storey	15	19%
Double storey	63	81%
Triple storey	0	0





## REFERENCES

- [1] Shuid, S. Low medium cost housing in Malaysia: Issues and challenges. *In APNHR conference*, 2004
- [2] Agus, M. R. The role of state and market in the Malaysian housing sector. *Journal of Housing and the built environment*. 17(1), 49-67, 2002.
- [3] Jamal, S. niqash. Retrieved from economy: <http://www.niqash.org/articles/?id=3368&lang=en>, 2004.
- [4] Hanif, M., Hafeez, S. and Riaz, A. Factors affecting customer satisfaction. *International Research Journal of Finance and Economics*. 60, 44-52, 2010.
- [5] Davara, Y., Meir, I. A. and Schwartz, M. Architectural design and IEQ in an office complex, healthy buildings: creating a healthy environment for people. In: de Oliveira Fernandes, E. et al. (eds.). *Proceedings of the International Conference on Healthy Building*, 2006, (pp. 77–81). Lisbon: vol. III.
- [6] Van der Voordt, T. J. and Maarleveld, M. Performance of office buildings from a user's perspective. *Ambiente construído*, 6, 7-20, 2006.
- [7] Khalil, N. and Nawani, A.H. Performance analysis of government and public buildings via post occupancy evaluation. *Asian Social Science*. 4 (9), 103–112, 2008.
- [8] Ibem, E.O., Aduwo, E.B., Uwakonye, O. Adequacy of incremental construction strategy for housing low-income urban residents in Ogun State, Nigeria. *Built Environment Project and Asset Management* 2 (2), 182–194, 2012.
- [9] Jiboye, A. D. Significance of house-type as a determinant of residential quality in Osogbo, Southwest Nigeria. *Frontiers of Architectural Research*, 2014.
- [10] Cronin Jr, J. J. and Taylor, S. A. Measuring service quality: a re-examination and extension. *The journal of marketing*. 55-68, 1992
- [11] Drucker, P.F. *The Practice of Management*. Harper Row. New York, 1954.
- [12] Victor, B. and Boynton, A. C. *Invented Here. Maximizing Your Organization's Internal Growth and Profitability. A Practical Guide to Transforming Work*. Harvard Business School Press, Harvard, 1998.
- [13] Oliver, R. L. and Linda, G. Effect of satisfaction and its antecedents on consumer preference and intention. *Advances in consumer research*. 8(1), 88–93, 1981.
- [14] Fornell, C. A national customer satisfaction barometer: The Swedish experience. *Journal of marketing*. 56(1), 6–21, 1992.
- [15] Latham, M. *Constructing the Team: Joint Government and Industry Review of Construction and Procurement Arrangements in the U.K.* Construction Industry, HMSO, London, 1994.
- [16] Egan, J. *Rethinking construction*. Department of Environment, Transport and the Region, 1998.
- [17] Bowen, P., and Hindle, R.D. (eds) 1999. *Customer Satisfaction. A Focus for Research and Practice in Construction*. 5–10 September 1999, London.
- [18] MacDuffie, J. P., Sethuraman, K. and Fisher, M. L. Product variety and manufacturing performance: evidence from the international automotive assembly plant study. *Management Science*. 42(3), 350–369, 1996.

- [19] Stalk, G. and Hout, T. M. *Competing against time: How time-based competition is reshaping global markets*, 1990. (pp. 188-91). New York: Free Press.
- [20] Halman, J. I., Hofer, A. P. and Van Vuuren, W. Platform-Driven Development of Product Families: Linking Theory with Practice. *Journal of Product Innovation Management*, 20(2), 149-162, 2003.
- [21] Van den Thillart, C. C. A. M. *Customised Industrialisation in the Residential Sector: Mass customisation modelling as a tool for benchmarking, variation and selection*. Boom Koninklijke Uitgevers, 2004.
- [22] Ball, M., Lizieri, C. and MacGregor, B. *The Economics of Commercial Property Markets*. Routledge, London, 1998.
- [23] Barlow, J. From craft production to mass customisation. Innovation requirements for the UK housebuilding industry. *Housing Studies*. 14(1), 23-42, 1999.
- [24] Kendall, S. and Teicher, J. *Residential open building*. E & FN Spon, 2000.
- [25] Barlow, J., Childerhouse, P., Gann, D., Hong-Minh, S., Naim, M., and Ozaki, R. Choice and delivery in housebuilding: lessons from Japan for UK housebuilders. *Building research and information*. 31(2), 134-145, 2003
- [26] Gann, D. M. Construction as a manufacturing process? Similarities and differences between industrialized housing and car production in Japan. *Construction Management & Economics*, 14(5), 437-450, 1996.
- [27] Noguchi, M. The effect of the quality-oriented production approach on the delivery of prefabricated homes in Japan. *Journal of Housing and the Built Environment*. 18(4), 353-364, 2003.
- [28] Wolters, M. J. J. *The business of modularity and the modularity of business*. PhD Thesis, Rotterdam, Erasmus University Press, 2001.
- [29] Yusof, N. A., and Mohd Shafiei, M. W. Factors affecting housing developers' readiness to adopt innovative systems. *Housing Studies*. 26(03), 369-384, 2011.
- [30] Hurtubia, R., Gallay, O. and Bierlaire, M. Attributes of households, locations and real-estate markets for land use modeling. Sustainability working paper 2.1. Lausanne, 2010.
- [31] Opoku, R. A. and Abdul-Muhmin, A. G. Housing preferences and attribute importance among low-income consumers in Saudi Arabia. *Habitat International*. 34(2), 219-227, 2010.
- [32] Kurdistan bord of investment. [Online] [Cited: 30 August, 2014.] <http://kurdistaninvestment.org/summary.html>.
- [33] Majid, M. A. and McCaffer, R. Assessment of Work Performance of Maintenance Contractors in Saudi Arabia. *Journal of management in Engineering*. 13(5), 91-91, 1997.
- [34] SPSS FAQ. Institute for Digital Research and Education. [Online] Dec 12th, 2014. <http://www.ats.ucla.edu/stat/spss/faq/alpha.html>. Houseing- Real Estate.

## **An Analysis of Occupational Accidents in the Demolition Works**

Hüseyin Ertas<sup>1</sup>, Ali Sayıl Erdoğan<sup>2</sup>

<sup>1&2</sup>*Department of Civil Engineering, Fırat University, Elazığ, Turkey*

<sup>1</sup>*huseyin\_ertas@yahoo.com*

<sup>2</sup>*aserdogan@bingol.edu.tr*

### **ABSTRACT**

The significance of occupational health and safety is understood better day by day, and in this respect, countries make various arrangements and work. Measures are to be taken against occupational accidents and diseases are determined, laws, regulations and legislations are made accordingly. In the construction sector, which is one of the most dangerous sectors in terms of safety, thousands of accidents happen every year. Those accidents include a wide range of simple cuts and scratches and life changing serious injuries and death. It is also important to consider the demolition work, which is one of the branches of the construction sector and is permanently in our daily life, according to the occupational health and safety. In this article, the demolition work is discussed according to the statistics of the occupational health and safety, and occupational accidents in the demolitions are considered. The accidents studied and classified are taken from all 653 occupational accidents in the demolition works registered in 1984-2012 in the workers' section of the US Occupational Safety and Health Administration (OSHA). According to the analyzed records, each kind of hazard in the demolition works are evaluated with regard to different work procedures and the results are shown.

**Keywords:** Occupational Accidents, Demolition Works, Accident Analysis, Occupational Accidents in Demolition Work.

### **1. INTRODUCTION**

Today, the demolition work has become an indication of the economic activity of different countries. The presence of demolition works is considered as a sign of progress, improvement and growth [1]. Several urban transformation projects are applied in different cities of countries due to various needs of growth. Urban transformation projects also accelerate the demolition works. The hazards between the demolition works and construction works are generally common, however the demolition works has its own hazards. The substances in the composition of the materials demolished or removed (lead paint, in the presence of asbestos) and areas with sharp edges or protruding spikes may be examples of those hazards. Moreover, accidents like collapse and breaking glass due to the damage of the building during the demolition works also happen frequently. Demolition works are generally small-scale works, and it is a sector in which contractors are self-employed and workers are unqualified [2]. In addition, if non-professional demolition companies are not inspected according to the occupational health and safety, they may increase the likelihood of accidents.

Demolition works is a type of job that is always requested to be faster and cheaper than general construction works. In the project management sector there are three important variables that have to be taken into account, the time, cost and the

quality of work. If deadline is low and the cost is cheaper then the labor quality is generally poor. In addition, due to the different types of structures and various techniques of demolition, it makes demolition works more complicated [3].

In United States there is not enough data specifically stating the number of injuries and fatalities occurring in the demolition works [4]. OSHA indicates that nearly 1,000 citations for violations of OSHA's construction demolition standards between 2009 and 2013. The citation issued resulted a failure to conduct an engineering survey determining the state of the structure before demolition [5]. In United States 945 demolitions occurred and 11,615 workers were employed in 1994 [6].

The demolition works in the construction industry is a type of job that is very hazardous in which fatal and non-fatal occupational injuries occur most frequently. In this article, the demolition works is discussed according to the occupational health and safety, the occupational accidents in demolition works are considered. There are limited databases in terms of occupational health and safety. According to study the accidents classified are taken from all 653 occupational accidents in demolition works registered in 1984-2012 in the workers' section of the US Occupational Safety and Health Administration (OSHA). OSHA database is a strong and effective database in terms of safety and health. Because employers must report all work-related fatalities and hospitalization within 24 hours to OSHA. In the analyzed records, each kind of hazard in demolition works is evaluated with regard to different work procedures and the results are shown.

## 2. DEMOLITION WORKS IN TERMS OF HEALTH AND SAFETY

Demolition is defined and/or stated in the various standards of different countries [7], [8], "Demolition work" means complete or partial destruction, dismantling, wrecking or taking out any structural member of a building.

Demolition work (demolishing or dismantling buildings or other structures) is one of the most dangerous works that the severity of the accidents in demolition works are quite high. Due to this high risky work, at the project planning phase very serious measures should be taken in demolition works especially in terms of safety. A good demolition project should be prepared for a good plan predicting the hazards beforehand. Design, planning and implementation are the three basic stages of a demolition project and should be considered as projects independent of each other [9]. Health and safety measures are to be taken in each stage and should be studied considering the significant factors in Figure 1. After defining those factors, the health and safety management strategies are to be implemented and should be determined.

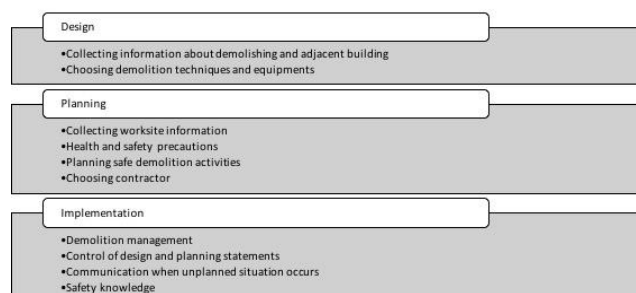

FIGURE 1. Significant health and safety factors during the demolition process phases

### 3. MATERIALS AND METHODS

This study started with literature review by searching several data bases [10] - [14] and sources [7] - [9], [15] - [20]. The search included the key descriptions: occupational accidents; construction accidents; demolition works; demolition accidents; occupational safety; occupational safety in construction; accident analysis; occupational accidents in demolition work and accident analysis in demolition works. Based on the literature types and classifications of accidents occurring in the construction sector and demolition works are inspected. In Table 1, the kind of hazards that happen in the work procedures are shown based on inspected accident reports and literature researches [7] - [8], [10] - [11], [21] - [24], [25] - [26].

TABLE 1.  
The kinds of hazards occurring in the demolition work procedures

Demolition Work Procedures	Hazard/Accident Type*
1. Exposure to Asbestos	1
2. Compressed Air and Air-operated devices	6,7
3. Control of Chemicals Hazardous to Health	
4. General Demolition Procedure	2,3,10
5. Dust	
6. Demolition Machines	3,6,7,8,10
7. Risk of Fire ( Works of Demolition and Dismantling)	9
8. Demolition without Machines (Manual)	4,5,7
9. Hand Tools	5,7
10. Fencing	4,5,7
11. Working at Height	2,3,4,7,10
12. Active Service in the Area	3
13. Manual Operation	5
14. Noise – General	
15. Working near Roads and Sidewalks	8
16. Mobile Scaffoldings	2,3,7,10
17. Slipping, Tripping and Falling	4,5
18. Soft Dismantling Work in Buildings	4,5,7,10
19. Third Persons and Common People	
20. Working on Mobile Elevating Work Platform	2,3,7,10
21. Loading Containers	2,6,7,8
22. Hand Contact with Broken Glass	4,5,7
23. Working on Stairs	3,4
24. Manually Operated Grinders	5,7
25. Dismantling Asbestos	1,5,10
26. Working with Vibratory Compactors	7
27. Excavations	2,3,7
28. Remote Demolition of Buildings	2,3,6,7,8
29. Crushing and Grinding of Materials	6,7,10
30. Dismantling of Steel Constructions	2,3,6,7
31. Environmental Effects	
32. Personal Protective Equipment	
33. Demolition- Falling Materials	7
34. Traffic Management	6,7,8

\* 1. Asbestos Exposure 2. Overturn/Collapse of buildings or structures 3. Electric Shock 4. Slipping/ Tripping/Fall/Stumbling 5. Cuts/Scratches/Jamming/Hitting/Puncturing/Manual Operation 6. Machine Accidents 7. Hit or Fall of Objects/Flying Debris 8. Traffic Accident 9. Fire 10. Falling from Heights

#### 3.1 DATA COLLECTION FROM THE ACCIDENT REPORTS

The source of data is official statistics and records archived by the US Occupational Safety and Health Administration [27]. The works collected by the

Occupational Safety and Health Administration (OSHA) shows the work-related injuries and illness' data obtained from companies within specific industries, and also shows the employment size specifications.

The Accident Investigation Search page allows us to search the OSHA's Integrated Management Information System (IMIS) enforcement database for casualties which contain specified terms. This is obtained from the Accident Investigation (OSHA-170) form. The database is updated daily. In the past, the term "accident" was regarded as an unplanned, unwanted event. To many, "accident" suggests an event that was random, and could not have been prevented. Since nearly all worksite fatalities, injuries, and illnesses can be prevented, OSHA suggests using the term "incident" investigation. Incident investigations are those that focus on determining and correcting root causes, not on finding fault or blame. This study analyzes all 653 demolition accident records archived by the OSHA from 1984 until 2012.

### 3.2 CLASSIFICATION OF ACCIDENTS

From the demolition accident search results it can be seen the damages of the accident (fatal or non-fatal), the main causes of the accidents (collapse, fire, etc.) and also shows the demolition work procedures. Furthermore, important types of demolition accidents are classified according to the demolition work procedures (Table 2).

TABLE 2.  
Accident types in terms of work procedures

Work Procedures	1	2	3	4	5	6	7	8	9	10	11	12	
Work Procedures / Hazards	1.General Demolition	2.Demolition Machines	3.Demolition of Steel	4.Working with Scaffolding	5.Manual Operation	6.Active Service in the Area	7.Fire	8.Mobile Scaffolding	9.Working at Heights	10.Non-Falling	11.Asbestos	12.Others	Total
1.Collapse of Buildings	16	0	15	0	0	0	0	3	0	0	0	1	18
2.Falling from Heights	11	5	9	0	1	0	0	8	2	0	0	0	16
3.Struck by Falling Objects	65	29	14	0	5	0	0	1	1	1	0	5	130
4.Falling /Slipping/Stumbling	2	0	1	2	1	0	0	0	0	0	0	7	39
5.Asbestos Exposure	0	0	0	0	0	0	0	0	0	0	3	0	3
6.Electric Shock	1	1	0	0	0	16	0	0	0	0	0	0	18
7.Fire	0	0	0	0	0	0	1	0	0	0	0	0	16
8.Machine Accidents	0	54	0	0	0	0	0	2	3	0	0	3	62
9.Traffic Accidents	0	1	0	0	0	0	0	0	0	0	0	1	2
10.Cuts /Scratches	0	0	0	0	1	0	0	0	0	0	0	0	13
11.Others	4	0	0	0	0	0	0	0	0	0	0	1	17
<b>Total</b>	<b>35</b>	<b>90</b>	<b>39</b>	<b>2</b>	<b>2</b>	<b>16</b>	<b>1</b>	<b>1</b>	<b>3</b>	<b>1</b>	<b>3</b>	<b>3</b>	<b>65</b>
	<b>6</b>			<b>8</b>	<b>0</b>		<b>6</b>	<b>4</b>	<b>1</b>	<b>0</b>		<b>0</b>	<b>3</b>

The 10 types of hazards shown in Table 2 are a result of the 34 different types of work procedures shown in Table 1. And these hazards are based on real accidents. Also, the 34 different types of work procedures shown in Table 1.

have been summarized to 12 work procedures shown in Table 2. The most common work procedures have been reduced to 11 and the 23 different work procedures shown in Table 1 falls under “other” in Table 2. And the total is 12. The summarization occurred for the following two reasons. The first reason is that 95% of all accidents occur as a result of the 11 kinds of work procedures shown in Table 2. The other reason is that the accidents occurring as a result of the “other” work procedures already exist in the 11 work procedures. For instance, one of the work procedures, “General Demolition Procedure”, has the hazard of “Falling from heights”. However, “Working at Heights” is already a sub-procedure of the “General demolition procedure”. If an evaluation is to be made considering the previous studies it can be seen that the rate of the accidents in demolition works in the construction sector has increased [22], [23]. While falling is the first in the rank of the results of accidents in construction in general, the collapse of buildings is the first in demolition works. It is stated that falling from heights and falling objects come next in the rank as the most common accident types.

According to the research of the 653 accident reports, hazards causing death, injury or any kind of health problems. It can be easier to take the advantage of that data with checklists focused on hazards. For instance, looking at the statistics in Figure 2, it can be seen that 49% of accidents resulting in death are caused by the collapse of buildings.

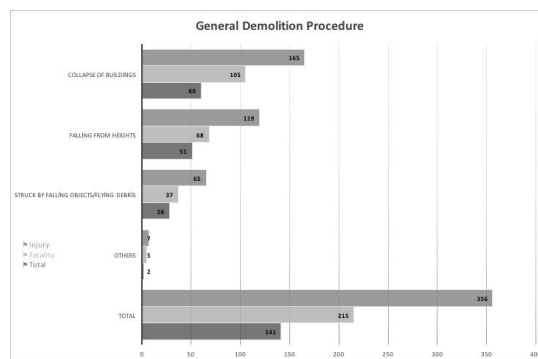

FIGURE 2. Amount of accidents resulting in death or injury in general demolition procedure

On the other hand, according to Figure 3, the percentage of fatality in harming the other workers on site is 45% and the percentage of fatality in falling/hitting objects is 31%. According to this the fatality rate in harming the other workers is higher than the fatality rate in falling/hitting objects. This data gives stronger information about what kind of accidents happen in what kind of work procedures.

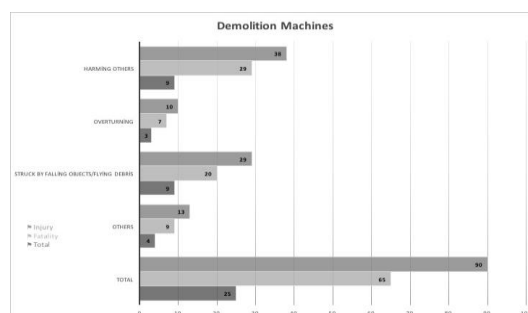

FIGURE 3. Amount of accidents resulting in death or injury caused by demolition machines



#### 4. RESULTS AND DISCUSSION

The above mentioned considerations can provide extensive information to help assess the severity potential. The severity of the workplace accidents and the possibilities are important factors to understand occupational accidents. For example, Figure 4 shows demolition fatalities between the years of 1984 and 2012 in US. Companies can use this information to prioritize their occupational focus when assessing the severity of potential accidents. The most occurring fatal accidents are shown in Figure 5. According to Figure 4 and Figure 5, the demolition works have high rate of occupational fatality. Most of fatality occurs in the collapse of buildings, falling from heights, machine accidents and electrocutions.

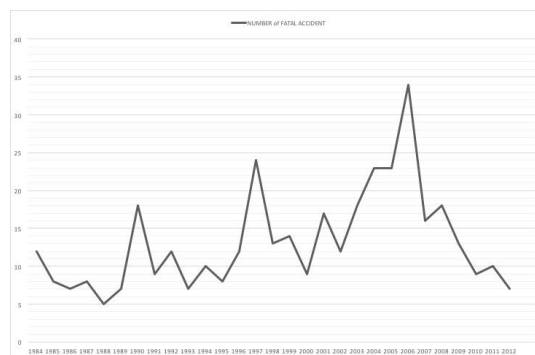

FIGURE 4. Demolition Fatalities

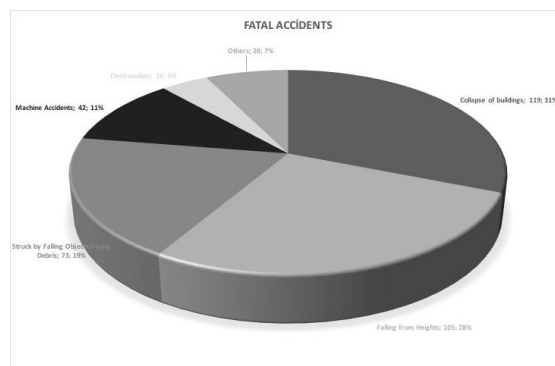

FIGURE 5. Fatal Accidents

The above figures do not show the safety precautions in the demolition works. But with this data there can be a strategy made in order to deal with the injuries caused in the demolition works and also how to prevent those accidents from occurring.

It is difficult to calculate the possibility of accidents in demolition works in the construction works because of the existing reporting systems. This is because the reporting systems are generally for continuously repeated tasks in other sectors and therefore the above mentioned concepts are not suitable for the construction sector in which there are lots of uncertainties. In the construction sector, even if two construction projects are same as each other, they differ because of the uncertainties of the construction sector.

There are studies in literature that prove that accidents in each worksite can be very different from each other [28]. In Table 3, there are fatal accidents, injury

accidents and annual average of accidents in demolition works according to the 653 accident reports recorded between the years of 1984 and 2012 by the worker's section of US Occupational Safety and Health Administration (OSHA). As it can be seen in Table 3, the rates shown by percentages gives a good idea on the severity and probability of accidents.

In the study, the value of the accident probability is reached by calculating the percentage of accident types in occupational accidents occurring in demolition works. As a result, it can be calculated the probability of all types of accidents according to the types of work procedures. According to the 653 accident reports the different types of accidents were classified in terms of demolition works, and the number and the rate of the accidents are found. A classification was made according to insufficient data and it was not suitable for analyzing a complete conclusion, but it makes it possible to evaluate the situation of the occupational safety in demolition works in general. According to Table 3, the rate of the probability of accidents according to the collapse of buildings is 28,79%. It is also shown that the "total fatal accidents" 383 and the majority of these accidents occurred in the "collapse of buildings" and "falling from heights", So precautions have to be taken while working in these procedures. In one year the total average accidents is 23,32 and 6,71 is due to collapse of buildings.

TABLE 3.  
Number of accident types and accident probability

Accident Report	Fatal Accident	%	Injury Accident	%	Total Accident	%	Average Accidents in a Year
<b>Collapse of buildings</b>	119	31,07%	69	25,56%	188	28,79%	6,71
<b>Falling from Heights</b>	105	27,42%	66	24,44%	171	26,19%	6,1
<b>Struck by Falling Objects/Flying Debris</b>	73	19,06%	57	21,11%	130	19,91%	4,64
<b>Machine Accidents</b>	42	10,97%	14	5,19%	56	8,58%	2
<b>Slipping/Tripping/Fall/ Stumbling</b>	14	3,66%	25	9,26%	39	5,97%	1,39
<b>Electric Shock</b>	16	4,18%	2	0,74%	18	2,76%	0,64
<b>Fire</b>	3	0,78%	13	4,81%	16	2,45%	0,57
<b>Cuts/Scratches/Jamming/Hitting/ Manuel Handling</b>	2	0,52%	11	4,07%	13	1,99%	0,46
<b>Traffic Accidents</b>	1	0,26%	1	0,37%	2	0,31%	0,07
<b>Asbestos Exposure</b>	0	0,00%	3	1,11%	3	0,46%	0,11
<b>Others</b>	8	2,09%	9	3,33%	17	2,60%	0,61
<b>Total</b>	383	100,00%	270	100,00%	653	100,00%	23,32

In order to accomplish a safe demolition work inspection should be done with the help of hazard checklists [25]. With the help of hazard checklists, the probability of accidents will be reduced in the demolition works. Hazard checklists also make it possible to do a risk analysis before each work that has risk.

#### 4.1 MOST FREQUENT DEMOLITION ACCIDENTS

According to the results from OSHA, the demolition accident reports show that six of the most frequent accidents are; collapse of buildings, falling from heights, struck by falling objects/flying debris, machine accidents, electric shocks and slipping/tripping/fall/stumbling are responsible for the 96.36% of all fatalities in the demolition works in the US. The most frequent accident causing fatalities is the

collapse of buildings/structures. The factors that lead to the collapse of buildings is that employees are can not know the stability of the structures, employees being at the wrong place at the wrong time during the demolition works, incorrect setup and early disassembling of scaffolds are the general cause of collapse during demolition works. Therefore, a supervisor must be appointed during the demolition works and it should be someone who is highly experienced in both demolition works and building construction. Before proceeding with the demolition works the supervisor should carefully examine the building plan of the property. If the building plan is not provided the supervisor should make a survey to identify the structural type so that the demolition work can be constructively planned. After the examining the building plan, a proper demolition method can be chosen and the supervisor should lay out the working process to the employees and other operatives. The supervisor should not only explain the working process but should also explain the safety risks involved and how to prevent the risk from occurring. Supervision should be done continuously.

Falling from heights can be categorized by the following factors; falling through fragile material, falling from edges and holes, falling from ladders and falling from scaffolds or work platforms.

Figure 3 divides the “Machine accidents” category into separate types of accidents. Most machine accidents are caused from harming others, struck by falling objects and overturning. This is because workers don’t follow the rules and regulations and it is suggested that there should be more signboards in the working sites to increase the awareness of accidents. Due to technology machines are used in demolition works and it has been advantageous in the safety and security. In the demolition sector, the usage of machines, has increase the efficiency of work and it has replaced the number of people needed to perform many operated tasks. However, this is also created one hazard which is being “struck by” workplace machinery. Due to human error these hazards are namely man machine interface.

TABLE 4.

The comparison of demolition accidents and overall construction accidents

Fatal Demolition Accidents		Fatal Construction Accidents	
Cause of Accident	% In Demolition	Cause of Accident	% In Overall Construction
1. Collapse of Buildings	31,1	1. Falls	39,9
2. Falls	27,4	2. Electrocutions	8,5
3. Struck by Objects	19,1	3. Struck by Objects	8,4
4. Machine Accidents	10,1	4. Caught-in/between	1,4

As can be seen from Table 4 the trend of demolition related fatal accident causes is different as compared to the trend of overall fatal construction accident causes. The data for overall construction accidents taken from OSHA accident reports is commonly known as “Fatal four” [29].

The rate of accidents in the construction sector and also during demolition works is regarded as high. However, accidents can be prevented with usage of appropriate safety measures. Reducing accidents and studying the effect of safety measures in demolition works must begin with an understanding on the causes, origins and patterns of the construction accidents. One of the main reasons of demolition accidents are because of unsafe working conditions and incorrect acts. Demolition accidents can be prevented by determining the main factors leading to accidents, techniques such as the theory of an accident and human errors can determine why accidents occur [17]. The main reasons for unsafe working conditions are the

following; (1) Unsafe working conditions is a naturel factor in a demolition site, (2) nonhuman related event(s), (3) employee or coworker incorrect acts and (4) Management actions. A worker can make mistakes whether the conditions were safe or not. For example, taking the decision to proceed working in dangerous conditions, not wearing appropriate personal protective equipment such as not wearing a hard hat or safety glasses, working while intoxicated, working with insufficient sleep, etc. [30]. OSHA stated that accidents can be reduced by the elimination of hazards, substitution, engineering control, administrative control and using personal protective equipment [31].

According to most frequent fatal demolition accidents which can be seen in Table 4, it is suggested to prepare a checklist in “what-why-how” manner prior to prevent demolition work accidents. Table 5 shows an implementation in “what-why-how” manner for operatives falls in the OSHA demolition accident reports.

TABLE 5.  
The Preparation of the “what-why-how” checklist for most frequent demolition accidents

WHAT (Cause/Hazard of Accident): Falls	
WHY (It happens - hazards)	HOW (To prevent or reduce)
Operatives falling from scaffold, roofs, MEWP's etc. due to several reasons.	<ol style="list-style-type: none"> <li>1. Working at heights should only be performed when no other practicable option is available.</li> <li>2. Working at heights risk assessment should be carried out.</li> <li>3. Some measures should be taken, e.g. safe working platforms, edge protection and fall protection.</li> <li>4. Safe working platforms should be inspected regularly.</li> <li>5. Wherever possible a safe working platform, should be set up by trained personnel.</li> <li>6. Fragile roof areas should be protected or access to the area should be prohibited. Edge protection should be set up at all open edges where falls could occur.</li> <li>7. All operatives should wear appropriate personal protective equipment and safety footwear.</li> <li>8. Operatives should wear a full body safety harness and restraint lanyard attached to a suitable anchor point when a fall is possible.</li> <li>9. Where fall arrest equipment is used, a rescue procedure and equipment must be available on site.</li> <li>10. Safety netting or air bags to be positioned underneath where restraint is impracticable</li> </ol>

The danger of demolition works can be reduced and prevented through correct planning, training, efficient standards and suitable personal protective equipment. Demolition works which are efficiently controlled can increase the safety of workers and the surroundings, which will then reduce injuries and accidents [32]. All demolition works should be planned efficiently before carrying out the work.

Planning involves collecting worksite information, health and safety precautions, planning safe demolition activities and choosing contractor. Personal protective equipment alone is not unique to demolition works, highly experience knowledge is required for the proper equipment for usage. Personal protective equipment selection, use, and maintenance are also important factors for construction management since demolition works frequently exposes workers to unique height risks. To maximize the protection of workers' safety nets, retractable lanyards, full body harnesses and specialized anchoring systems may be required for use [33]. The correct amount of information, good instruction and training must be available for the personnel to ensure that the work is done in a safe manner. Highly supervision is required during training and in the work as operatives may lack experience and awareness of the dangers which may be encountered during the work. The demolition of buildings and structures should be performed according to the recommended standards.

## 5. CONCLUSION

According to the research, it is proved that demolition accidents can be categorized effortlessly. The demolition accidents provided in the study gives detailed information about the causes of accidents. 77,6% of accidents are collapse of buildings, falling from heights and struck by falling/flying objects. The rate of accidents in the collapse of buildings can be reduced through proper supervision and experience in choosing the proper demolition method. Even if the simplest and safest method is used in demolition works, accidents still occur on records. The prevention of falling from heights and “struck by” accidents can be maximized by the proper use of equipment and in some situations the prevention of falling materials should be concerned.

The information about safety risks in demolition works is limited. Because there is less study focused on demolition safety, as a conclusion demolition works has generally been considered as a small area in the construction sector until now. It is also found that the rate of most fatal and severe accidents occur in the demolition works. This is why there should be more focus in the demolition works. A better understanding of the safety risks in demolition works is therefore needed to reduce demolition related accidents in the future. With increased development in countries, demolition work has become an important branch of the construction business and needs to be considered more. While the result of this study is based on very limited data; nevertheless, it has shown that there are differences between injury trends in demolition works and construction works. Safety precaution methods during demolition works must be different from normal construction works and should be with greater attention on how to bring down a building structure safely and how to avoid unintentional collapse.

Through the data gathered from this study, it can be concluded that proactive actions are required to overcome the safety issues in demolition works. Demolition works are performed even more every day.

There should be a common view on hazards in demolition works. The method of demolition should be chosen to provide health and safety but not according to the existing tools and materials. In respect to this, an effort can be made even to develop new demolition methods.

Most of accidents are attributed to human causes and that this is a trend likely to increase in proportion to the reliability and probable sophistication of the hardware tools. It is expected that “safety climate” provided in worksites may reduce the number of accidents. Workers’ social, psychological and financial aspects and also their working hours and health may be considered with regard to this climate.

Certain licenses and certificates should be required for the companies and individuals that will do demolition works. Everybody and every company shouldn’t be free to do demolition works, as they please. They should be subjected to certain criteria and qualifications. With the help of the easy to use “what-why-how” checklists created, controlled safety measures should be made in demolition sites and should be very practical.

## REFERENCES

- [1] R. Diven and Taylor. M.R, "Demolition Planning," in *The Architect's Handbook of Professional Practice*, Update 2006, J.A. Demkin, John Wiley & Sons, Inc.: Hoboken, New Jersey, United States of America, 2006, pp. 143-157.
- [2] C. Muianga, C. Rice, T. Lentz, J. Lockey, R. Niemier and P. Succop, "Checklist model to improve work practices in small-scale demolition operations with silica dust exposures," *International Journal of Environmental Research and Public Health*, vol. 9, pp. 343-361, 2012.
- [3] H.T. Hudgins, "Demolition of concrete structures," in *Concrete Construction*, vol. 32(1), Aberdeens Group, Addison, III, 1987, pp. 24-31.
- [4] Plan Ahead for Demolition Site Safety., [online] 2005  
<http://www.forconstructionpros.com/article/10304530/plan-ahead-for-demolition-site-safety> (Accessed: 4 November 2015).
- [5] Recent Fatalities Serve as a Reminder to Protect Workers from Demolition Hazards., [online] 2014  
[https://www.osha.gov/pls/oshaweb/owadisp.show\\_document?p\\_table=NEWS\\_RELEASES&p\\_id=26331](https://www.osha.gov/pls/oshaweb/owadisp.show_document?p_table=NEWS_RELEASES&p_id=26331) (Accessed: 4 November 2015).
- [6] NIOSH, NIOSH Special Hazard Review Identifying High-Risk Small Business Industries, Cincinnati, USA, 1999.
- [7] Safe Work Australia, Code of Practice Demolition Work, pp. 5, 2011.
- [8] Building Department Hong Kong, Code of Practice for Demolition of Building, pp. 2, 2004.
- [9] C. Anumba, B. Marino, A. Gottfried and C. Egbu, Research project: Health and safety in refurbishment involving demolition and structural instability, pp. 3-4, 2004.
- [10] New Zealand Demolition and Asbestos Association (NZDAA)., [online] 2013  
[www.business.govt.nz/worksafe/information-guidance/all-guidance-items/best-practice-guidelines-for-demolition-in-new-zealand](http://www.business.govt.nz/worksafe/information-guidance/all-guidance-items/best-practice-guidelines-for-demolition-in-new-zealand) (Accessed: 10 July 2015).
- [11] HSE, Demolition Available., [online]  
<http://www.hse.gov.uk/construction/safetytopics/demolition.htm> (Accessed: 4 November 2015).
- [12] ILO, International Labor Standards on Occupational Safety and Health., [online] <http://www.ilo.org/global/standards/subjects-covered-by-international-labour-standards/occupational-safety-and-health/lang--en/index.htm> (Accessed: 4 November 2015).
- [13] Safe Work Australia, Construction Statistics., [online]  
<http://www.safeworkaustralia.gov.au/sites/swa/statistics/industry/construction/pages/construction> (Accessed: 4 November 2015).
- [14] OSHA, Demolition: Construction in Reverse, with Additional Hazards., [online] <https://www.osha.gov/doc/topics/demolition/> (Accessed: 4 November 2015).
- [15] R.Y.M. Li and W. Poon, "Why Do Accidents Happen, A Critical Review on the Evolution of the Construction Accident Causation Models," *Construction Safety*, DOI: 10.1007/978-3-642-35046-7\_2, 2013.

- [16] B. Fabiano, F. Curro, A.P. Reverberi and R. Pastorino, "A statistical study on temporary work and occupational accidents: Specific risk factors and risk management strategies," *Safety Science*, vol.46, pp. 535–544, 2008.
- [17] S. Hosseinian and Z.J. Torghabeh, "Major Theories of Construction Accident Causation Models: A Literature Review," *International Journal of Advances in Engineering & Technology*, vol. 4, pp. 53-66, 2012.
- [18] L.H. Ringdahl, "Relationships Between Accident Investigations, Risk Analysis, and Safety Management," *Journal of Hazardous Materials*, vol:111, pp. 13-19, 2004.
- [19] T.R. Quarmby, "Safe, Healthy And Sustainable Demolition," Ph.D. dissertation, Loughborough University, Loughborough, England, 2011.
- [20] D.N.M.A. Abdullah and G.C.M. Wern, "An Analysis of Accidents Statistics in Malaysian Construction Sector," in *International Conference on E-business, Management and Economics*, 2010.
- [21] W. Zaharuddin, I. Paraskevas, and C. Liu, "Accident avoidance importance for building demolition," in *CIB W099 2009: Working together: planning, designing and building a healthy and safe construction industry*, 2009, pp. 9-14
- [22] G.E. Gürcanlı and U. Müngen, "Analysis of construction accidents in Turkey and responsible parties," *Industrial Health*, vol. 51, (6) pp. 581-595, 2013.
- [23] G.E. Gürcanlı, "A Risk Analysis Method for Occupational Safety in Construction Sites Using Fuzzy Sets," Ph.D. dissertation, İstanbul Technical University, İstanbul, Turkey, 2006.
- [24] Subpart T – Demolition., [online]  
[www.osha.gov/pls/oshaweb/owadisp.show\\_document?p\\_table=STANDARDS&p\\_id=10942](http://www.osha.gov/pls/oshaweb/owadisp.show_document?p_table=STANDARDS&p_id=10942) (Accessed: 10 July 2015).
- [25] A Buckler (Haulage), *Construction Phase Plan (Demolition)*, pp. 75-114, 2015.
- [26] N.R.B. Abas, "Risk Assessment for Demolition Works in Malaysia," MSc dissertation, Universiti Malaysia Pahang, Malaysia, 2010.
- [27] OSHA, *Fatality and Catastrophe Investigation Summaries.*, [online]  
<https://www.osha.gov/pls/imis/accidentsearch.html> (Accessed: 5 November 2015).
- [28] N. Seixas, J. Sanders, L. Sheppard and M.G. Yost, "Exposure assessment for acute injuries on construction sites: Conceptual development and pilot test," *Applied Occupational and Environmental Hygiene*, vol. 13, (5) pp. 304-312, 1998.
- [29] OSHA, *Commonly Used Statistics.*, [online]  
[30] <https://www.osha.gov/oshstats/commonstats.html> (Accessed: 10 November 2015).
- [31] T.S. Abdelhamid and J.G. Everett, "Identifying root causes of construction accidents," *Journal of Construction Engineering and Management*, vol. 126, (1) pp. 52-60, 2000.
- [32] OSHA. *Introduction to OSH*, pp. 1-39, 2012.
- [33] M.G. Bhandari, V.K. Kulkarni and R.K. Malviya, "Building demolition: ground to earth important as construction," *International Journal of Emerging Technology and Advanced Engineering*, vol. 3, (4) pp. 396-401, 2013.
- [34] Dust Boss, [online] 2015 <http://www.dustboss.com/support/dust-related-health-safety-issues/safety-and-health-training/> (Accessed: 5 November 2015).

## **Advanced Models for Soil-Structure Interaction Problems**

Genes, M.C.

*Civil Engineering Department, Engineering Faculty, Zirve University, Gaziantep, Turkey  
cema.genes@zirve.edu.tr*

### **ABSTRACT**

A finite element (FE) and boundary element based soil–structure interaction (SSI) models are presented and parallelized for applications on distributed systems. The SSI models are established by combining two methods: the Scaled Boundary Finite Element, Infinite Element or Boundary Element Method for modeling the soil region extending to infinity (far-field), and the standard FE for the finite region (near-field) and the structure. By using these combined models, several computer programs for harmonic and transient analyses of soil–structure systems are coded. The models are investigated by solving various example problems existing in the literature. The results of the models agree with the results presented in the literature for selected problems. The advantages of the model are demonstrated through these comparisons. In order to decrease the computation time and achieve the solution of large-scale problems, the models are parallelized. As a result of these parallel solutions, significant time is saved for large-scale problems.

**Keywords:** Soil–structure interaction; Parallel; Finite element, Boundary element; Impedance.

### **1. INTRODUCTION**

In soil–structure interaction (SSI) problems the ability to predict the coupled behavior of the soil and structure is necessary. Therefore, these problems require combined soil and structure models. While structure models are very well established in the literature, soil models involve complicated analysis due to their unbounded nature. The main difficulty in modeling the soil region arises from the propagating wave characteristics in the soil medium. The main goal of many related engineering studies is to develop SSI models, which are reliable and easy to implement. There are numerous valuable works in literature, which are focused on the proposition of mathematical models for soil region of the SSI problems. Most of these mathematical models require a solution defined over a computational mesh. For practical purposes, a limited size computational mesh is required.

Therefore, soil region, which extends to infinity, is truncated at certain regions called artificial boundaries. The waves propagating through the soil medium should be dissipated at the artificial boundaries of the computational mesh. This condition somehow has to be satisfied in the mathematical models. The main challenge in SSI analyses is the representation of energy dissipated at the artificial boundaries.

Soil region, which in many cases presents a complex and nonlinear behavior, can be discretized using the Finite Element Method (FEM), the Boundary Element Method (BEM) or hybrid models. All of these have advantages and disadvantages depending on the applied problem.



FE models require a large-scale mesh to represent the surrounding soil medium (near-field), which is bounded by the far-field that is represented by artificial boundaries. In numerical modeling of wave propagation problems the presence of artificial boundaries introduces spurious reflections, which contaminate the solution. This error can be avoided by introducing special boundary conditions, which might be referred to as radiation damping. These special boundary conditions such as transmitting, non-reflecting and silent boundaries absorb the wave energy. The non-reflecting viscous boundaries developed by Lysmer and Kuhlemeyer [1] and White et al. [2] have been widely used for various dynamic soil–structure interaction problems. These boundaries are only capable of transmitting plane and cylindrical waves and, therefore, must be located far away from the structure or source of dynamic load. This results in large- scale FE meshes.

Another way of treating these artificial boundaries might be introducing infinite elements for modeling the far-field of SSI problems. These elements were proposed by Bettess [3] to obtain solutions to static and steady- state dynamic problems. Since then, many authors, including Medina and Penzien [4], Yang and Yun [5] and Yerli et al. [6] have successfully extended the infinite element formulation to model wave propagation problems in an infinite medium. Similar to the artificial boundary treatment discussed in the previous paragraph, a fine FE mesh is required to define the near-field for reliable predictions when infinite elements are used along the truncated regions.

For a complex or arbitrary shaped body subjected to dynamic loads requires the use of discrete numerical methods such as the finite element method (FEM) or the boundary element method (BEM). These two methods can be formulated in time or frequency spaces, and each has relative advantages and disadvantages. The properties of the system to be analyzed, such as geometry, material properties, boundary conditions, and type of loading are the dominant effects to make a decision of which methods should be used. The FEM is well-suited for linear and non-linear behavior of complex or arbitrary shaped structures with non-homogeneous and anisotropic material properties. For systems with infinite or semi-infinite extension, however, the use of the BEM is more effective than FEM. The scaled boundary-finite element method (SBFEM) is an alternative and effective method for modeling systems with finite and infinite extension having non-homogeneous and incompressible material properties. The SBFEM is developed and applied to SSI problems both in time and frequency domains by Wolf and Song [7], and Wolf [8]. Recently, it is applied to the structural elastodynamics [9,10], crack [11–13] and fracture mechanics [14,15] problems.

In order to profit from advantages and evade disadvantages of these methods, many authors have developed combined formulations for SSI problems which are composed of finite and infinite media. Numerous studies on coupled models are available in the literature. The coupled finite element and boundary element method (FE-BEM) is the most widely used combined model in both time and frequency domains [16–18]. The main developments regarding FE-BEM combinations are not discussed in this paper, but comprehensive reviews can be found, for instance, in Beer and Watson [19] and Stamos and Beskos [20]. The progress of the BEM for numerical solutions for elastodynamic problems and major developments are reported in details in the important reviews made by Beskos [21,22]. For this work,

it is also convenient to point out some recent publications: Antes and Steinfield [23], dealing with 3D BEM/BEM coupling in time domain; Guan and Novak [24], to analyse 2D transient problems using a BEM formulation combined with rigid strips; Von Estorff and Firuziaan [25], dealing with a coupled BEM/FEM approach for nonlinear soil-structure interaction in time domain; and Von Estorff and Hagen [26], to analyse 3D transient elastodynamic problems by an iterative coupled BEM/FEM Model in time domain. In addition to these studies, a BEM based formulation and a computer programme is proposed by Tanrikulu et al. [27] for 2D and 3D SSI problems with layered domains. Another combined model is coupled finite element and scaled boundary-finite element method (FE-SBFEM) in frequency domain for large-scale SSI systems [28]. It can be emphasised that, if BEM is used for modeling a non-homogeneous (layered) soil media extending to infinity (Fig. 1), the interface between the soil layers and the free surface of the soil must be discretized, which increases the computational load considerably. In addition, on the boundaries extending to infinity, discretization needs to be truncated, and this leads to errors. In the study of Tanrikulu et al. [27], the BEM formulation for infinite non-homogeneous media was improved for three different layers. However, SBFEM can easily model non-homogeneous soil media with many layers extending to infinity. In the SBFEM, the boundary conditions at the interfaces and at the free surface can be satisfied closely and automatically without any further discretization. In addition, SBFEM satisfies the radiation condition and calculates the dynamic response of the media extending to infinity at a truncated media without requiring fundamental solution as in BEM. These are the main advantages of the SBFEM. Modeling non-homogeneous soil media with layers by SBFEM requires the soil media to be discretized until rigid bedrock or homogeneous half space is reached. If the surface of the rigid bedrock is horizontal, this problem can be handled by using a special case of SBFEM which sets the similarity center at infinity [7]. For the layered mediums on homogeneous half-space the satisfaction of the similarity is handled by using the structure medium interface outwards as mentioned in Wolf and Song [7]. The SBFEM results in a system of first-order non-linear ordinary differential equations (ODE) for the dynamic stiffness matrix of the soil extending to infinity at the boundary with the independent variable frequency. Through the SBFEM, dynamic stiffness matrix calculations of the infinite media are performed through an integration algorithm in a pre-defined frequency interval. But in the SBFEM formulations, the radiation condition is satisfied at high frequency values. Therefore, it requires some extra calculations until the desired frequency level is reached. Hence, for large-scale problems (i.e. structures resting on a layered soil and three-dimensional problems) the computational load increases significantly. The time measurements made showed that the vast majority of the time is spent for the solution of ODE resulting from SBFEM. In the studies of Genes and Kocak [28,29], the shortcoming of the SBFEM for large-scale SSI problems was considerably eliminated by introducing a parallelized algorithm for the solution of first-order non-linear ODEs. More recent studies are found in Cunha et al. [30], Bird et al. [31], and Park and Heister [32]. Cunha and et al. [30] applied the standard and portable libraries for the parallelization of BEM codes; Bird et al. [31] used a coupled BEM/SBFEM formulation to analyses linear elastic fracture mechanic problems; Park and Heister [32] proposed a parallelization procedure for the analysis of unsteady BEM problems. Most of these studies have worked on a structural problem or parallel implementation itself.

## 2 PHYSICAL MODELS AND NUMERICAL APPROACHES

### 2.1 FINITE ELEMENT FORMULATION

The characteristics of visco-elastic plane-strain structures such as strip foundations, tunnels, gravity dams, retaining walls etc. can be specified by state variables acting at a plane of any section of the structure. The dynamic response of these plane-strain structures is described by the equation of motion resulting from FEM formulation as,

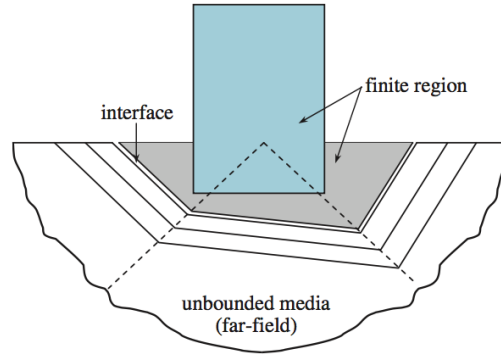

FIGURE 1. A soil-structure interaction problem

$$M\ddot{U} + C\dot{U} + KU = F(t) \quad (1)$$

where  $M$ ,  $C$  and  $K$  designate the mass matrix, the damping matrix denoting inner or structural damping of the structure, and the static stiffness matrix, respectively.  $F(t)$  characterizes the time dependent dynamic load acting on the structure caused by the external harmonic or transient vibrations or seismic excitation. The dynamic response is described by the acceleration  $\ddot{U}$ , the velocity  $\dot{U}$ , and the displacement  $U$ . Equation of motion can be written as below in frequency space by ignoring the damping matrix and taking in to account the hysteretic damping,

$$\{(1 + 2iz)K - \omega^2 M\}U^f = F^f \quad (2)$$

where  $z$ ,  $\omega$ ,  $i$  and superscript  $f$  designate hysteretic damping, frequency, imaginary number and frequency space, respectively. In this study, all the formulations will be derived in frequency space. For the sake of simplicity, the superscript  $f$  will be omitted. The term in curly brackets in Eq. (2) is referred to as the dynamic stiffness matrix and will be represented as  $S$  in this study. For the finite region in Fig. 2(a), Eq. (2) can be written in matrix form as,

$$\begin{bmatrix} S_{ss} & S_{si} \\ S_{is} & S_{ii} \end{bmatrix} \begin{Bmatrix} U_s \\ U_i \end{Bmatrix} = \begin{Bmatrix} F_s \\ F_i \end{Bmatrix} \quad (3)$$

where the subscripts  $i$  and  $s$  designate interaction and non-interaction nodes, respectively.

The unbounded media extending to infinity can be modeled by using infinite elements [4–6]. However, the use of infinite elements might require a fine mesh for

the finite region and/or far enough near- and far-field interfaces. These are some of the shortcomings of the infinite elements. Therefore, in these parallelized advanced models the unbounded media extending to infinity will be modeled by using BEM and/or SBFEM. In the following two sections the basics of BEM and SBFEM are presented.

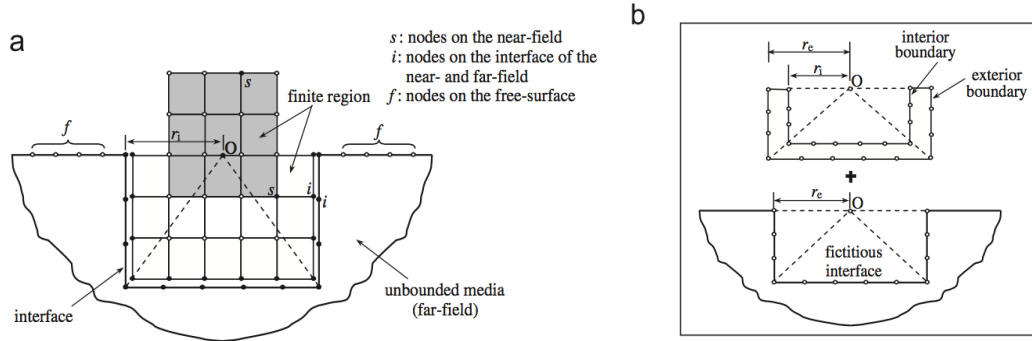

FIGURE 2. Fundamental concept of FEM with BEM and SBFEM: (a) combined SSI models; and (b) presentation of SBFEM

## 2.2. BOUNDARY ELEMENT FORMULATION

In BEM formulation, the dynamic response of homogeneous, isotropic and linear elastic structures in frequency domain is described by the system equation as,

$$\mathbf{H}\mathbf{U} = \mathbf{G}\mathbf{t} \quad (4)$$

where  $\mathbf{H}$  and  $\mathbf{G}$  are the system matrices obtained by the integration of the first and second fundamental solutions of BEM over the elements. The  $\mathbf{U}$  and  $\mathbf{t}$  are the displacement and the traction vectors, respectively. The system equations of an unbounded media composed of interaction and free nodes as shown in Fig. 2(a) can be written as

$$\begin{bmatrix} \mathbf{H}_{ff} & \mathbf{H}_{fi} \\ \mathbf{H}_{if} & \mathbf{H}_{ii} \end{bmatrix} \begin{Bmatrix} \mathbf{U}_f \\ \mathbf{U}_i \end{Bmatrix} = \begin{bmatrix} \mathbf{S}_{ff} & \mathbf{S}_{fi} \\ \mathbf{S}_{if} & \mathbf{S}_{ii} \end{bmatrix} \begin{Bmatrix} \mathbf{t}_f \\ \mathbf{t}_i \end{Bmatrix} \quad (5)$$

where the subscripts  $i$  and  $f$  designate interaction and free nodes, respectively. In the present formulation the soil media surface is assumed to be free of loads. Therefore, traction vector ( $\mathbf{t}_f$ ) of the free nodes is taken as zero, which leads Eq. (5) to be condensed as

$$(\mathbf{G}_{ii} - \mathbf{H}_{if}\mathbf{H}_{ff}^{-1}\mathbf{G}_{fi})^{-1}(\mathbf{H}_{ii} - \mathbf{H}_{if}\mathbf{H}_{ff}^{-1}\mathbf{H}_{fi})\mathbf{U}_i = \mathbf{t}_i \quad (6)$$

Multiplying both sides of Eq. (6) by a distribution matrix, one can obtain force-displacement relation pertaining to interface in compact form as

$$\mathbf{S}_B^\infty \mathbf{U} = \mathbf{F} \quad (7)$$

where  $\mathbf{S}_B^\infty$ ,  $\mathbf{U}$  and  $\mathbf{F}$  designate dynamic stiffness matrix, displacement and force vectors of the unbounded media calculated by BEM, respectively.

### 2.3. SCALED BOUNDARY FINITE ELEMENT METHOD FORMULATION

This model is based on the calculation of the dynamic stiffness matrix for a discretized soil media which extends to infinity. It is a BE-like method, but it does not require a fundamental solution. It is based on the FE formulation and satisfies the radiation condition at infinity while also decreasing the spatial dimension of the problem by one. This method requires similarity of the unbounded medium which is not always satisfied in practice [7]. For layered unbounded medium the similarity can be satisfied by moving the structure-medium interface outwards as shown in Fig. 1 to decrease the slope of the inclined surface beyond the corner points. In this method, a discretized cell along the near- and far-field interface is introduced (see Fig. 2(b)) with its interior boundary coinciding with the nodes on the interface of the near- and far-field, and its exterior boundary with the fictitious interface (see Fig. 2(b)). In the figure,  $O$  is the similarity center, and  $r_i$  and  $r_e$  represent the characteristic length of interior and exterior boundaries of the cell, respectively. Here, the unbounded media with the characteristic length  $r_i$  is to be analyzed to calculate its dynamic stiffness matrix. Assembling the dynamic stiffness matrix of the cell (which is straightforwardly determined from its static stiffness and mass matrices by FE formulation) and the unknown dynamic stiffness matrix of the unbounded media characterized by length  $r_e$  results in the unknown dynamic stiffness matrix of the unbounded media with length  $r_i$ . Through the use of compatibility and equilibrium equations between the cell and the bounded and unbounded media, the relation between the dynamic stiffness matrix of the faces of the cell are obtained in frequency domain in terms of static stiffness and mass matrices of the cell. Then, by taking the limit as cell width goes to zero and using similarity [7], the formulation leads to a first-order non-linear ODE for the dynamic stiffness matrix in the independent variable frequency ( $\omega$ ) as

$$(\mathbf{S}^\infty(\omega) + \mathbf{E}^1)(\mathbf{E}^0)^{-1}(\mathbf{S}^\infty(\omega) + (\mathbf{E}^1)^T) - (s - 2)\mathbf{S}^\infty(\omega) - \omega\mathbf{S}^\infty(\omega)_{,\omega} - \mathbf{E}^2 + \omega^2\mathbf{M}^0 = 0 \quad (8)$$

where,  $\mathbf{E}^0$ ,  $\mathbf{E}^1$  and  $\mathbf{E}^2$  designate the static stiffness matrices, and  $\mathbf{M}^0$  designates the mass matrix of the structure-media interface calculated by FEM formulation [7]. In order to propose an acceptable solution for the ODE given in Eq. (8), the boundary condition must satisfy the radiation condition in frequency domain. The radiation condition can be satisfied by choosing the truncated region at an infinite distance from the interface which corresponds to an infinite characteristic length  $r$ . However, by introducing the associated non-dimensional (ND) frequency  $a_0 = \omega r/c_s$ , infinite ND frequency (which would be the case for infinite  $r$ ) can also be achieved by an infinite  $\omega$  instead of an infinite  $r$ . In an actual calculation, the dynamic stiffness matrix to be used in Eq. (8) can be calculated by choosing a large frequency ( $\omega$ ). Thus, the high-frequency behavior of  $\mathbf{S}^\infty$  is studied examining the asymptotic expansion of the differential equation given in Eq. (9)

$$\mathbf{S}^\infty(\omega) \approx i\omega\mathbf{C}_\infty + \mathbf{K}_\infty + \sum_{j=1}^m \frac{1}{(i\omega)^j} \mathbf{A}_j \quad (9)$$

where,  $\mathbf{C}_\infty$ ,  $\mathbf{K}_\infty$  and  $\mathbf{A}_j$  designate dashpot matrix, spring matrix and unknown coefficient matrices of the asymptotic expansion, respectively.  $m$  in Eq. (9) represents the number of terms to be considered in the analysis, and  $i$  is the imaginary number. The details of the calculation of  $\mathbf{S}^\infty$  can be found in [7]. The calculated dynamic stiffness matrix by Eq. (9) represents the initial-value of the Eq. (8) for a high ND frequency, and it remains to solve Eq. (8) by Bulirsch-Stoer integration algorithm [33].

### 3 NUMERICAL EXAMPLES AND DISCUSSIONS

#### 3.1. TUNNEL-SOIL INTERACTION

To evaluate the accuracy of the model shown in Fig. 3(a) and to solve a large-scale soil structure interaction problem, underground transient vibrations induced by traffic loads in a tunnel embedded in a homogeneous and layered half-spaces are studied. The tunnel has a rectangular section with concrete lining. The tunnel and the surrounding soil are modeled by finite elements and the infinite media is modeled by BEM and SBFEM as shown in Fig. 3(b). In discretization of the problem, for the tunnel and the surrounding soil considered as near-field: 1196 8-node quadrilateral finite elements, for modeling the far-field extending to infinity in vertical direction: 85 constant boundary elements, for modeling the far-field extending to infinity in horizontal direction: 60 3-node line elements are used. The horizontal and vertical distances from the similarity center ( $O$ ) to the boundaries modeled by SBFEM and BEM are taken as  $5B$  and  $6B$ , respectively, where  $B$  is the half-width of the tunnel. The dimension of the tunnel structure is taken as  $5\text{ m} \times 6\text{ m}$ , and the embedment depth is  $4\text{ m}$ . The material properties of the tunnel are considered as Young's modulus:  $E_t=6.0 \times 10^6\text{ kPa}$ , mass density:  $\rho_t=2\text{ t/m}^3$  and Poisson's ratio:  $\nu_t=0.25$ . For the soil media, the material properties are taken as Young's modulus:  $E_2 = E_1 = 2.66 \times 10^5\text{ kPa}$ , the mass density:  $\rho_1 = \rho_2 = \text{t/m}^3$  and Poisson's ratio  $\nu_1 = \nu_2 = 0.33$ .

The material damping in the structure and the soil is not included as in the case analyzed by Estorff and Antes [34], and Kim and Yun [35]. This is the first case studied for tunnel-soil structure interaction to calculate the displacements at the bottom of the tunnel (Point A) and on the ground surface (Point B) resulting from traffic load, which is idealized as a rectangular impulse over  $20\Delta t$  as shown in Fig. 3(c) and applied to the bottom of the tunnel in the vertical direction.

The time period which is selected for the FFT is considered as  $24\text{ s}$  to observe the damping of the displacements generated by an impulse load applied in  $0.02\text{ s}$  time interval. The vertical displacements obtained at points A and B for the homogeneous half-space are compared with those by Estorff and Antes [34], and Kim and Yun [35] as shown in Fig. 4. The displacements are plotted against the dimensionless time ( $t_o = tc_{s1}/B$ ), in which  $c_{s1}$  is the shear wave velocity of the soil media. As can be seen from Fig. 4, reasonably good agreements can be observed between the results obtained by three different methods. The slight difference between the results could be explained because of the power of the artificial boundaries modeled by SBFEM and BEM which are transmitting the propagating waves very well without any reflection depended scattering. Generally, the reflection depended wave scattering at the artificial boundaries contaminates the results. Time delay can be noticed between the displacements at the two points on the bottom of the tunnel and on the ground surface.

As a second case, parametric studies are carried out to investigate the effect of the stiffness ratio ( $E_2/E_1$ ) of the soil layers in the layered half-space under the same impulse loading as in case one. The Young's modulus of the upper (first) layer is taken as  $E_1=2.66 \times 10^5\text{ kPa}$ , while three different values are considered for the underlying half-space  $E_2=1.2 \times 10^5$ ,  $6.00 \times 10^6$ , and  $3.00 \times 10^7\text{ kPa}$ . Fig. 5 shows that the maximum displacements at the two points decrease and the frequency content of the response moves into the higher frequency range while the stiffness ratio ( $E_2/E_1$ ) increases.



#### 4. CONCLUSION

In this paper, computational models are presented for harmonic and transient dynamic response of large-scale soil-structure interaction analysis using Parallelized Advanced Coupled FE-BE-SBFEM models. In the proposed models, the finite region, which might be considered as the structure, is modeled by the FEM. On the soil-structure interface, the boundary at the bottom of the finite media which is extending to infinity in vertical direction is modeled by the BEM, and the vertical boundary of the layers which is extending to infinity in horizontal direction is modeled by the SBFEM. These coupled models combines the three methods by using them in regions they are advantageous. The analyses are conducted in frequency space. Dynamic stiffness matrices pertaining to related regions of the SSI system are calculated by three methods, and combined by using the sub-structuring method.

Even though, several example problems were solved to verify and investigate the applicability of the model and the coded parallel algorithm, only one example is presented here due to space limitations. The obtained results of the model are compared with the data in the literature and in general a good agreement is noted. Comparisons showed that the Parallelized Advanced Coupled FE-BE-SBFEM model can be used in SSI analyses of 2D large-scale structures efficiently and accurately under transient load. The results also demonstrated the importance of using coupled models for analyzing complex structures and non-homogeneous unbounded media.

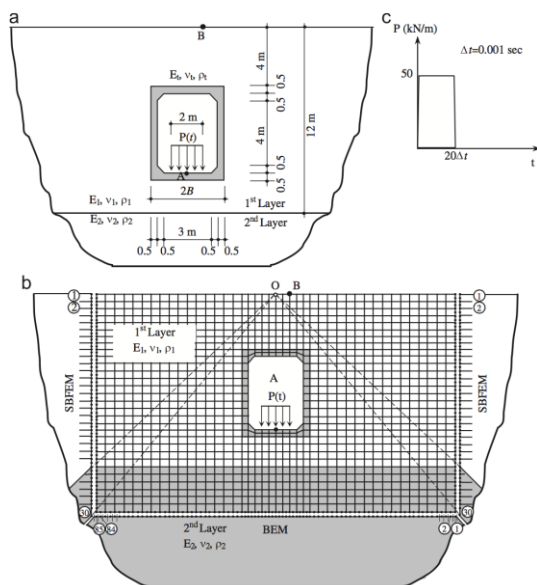

FIGURE 3. Tunnel in an elastic half-space: (a) Tunnel-soil interaction system; (b) Analyses model; and (c) History of traffic loading,  $P(t)$

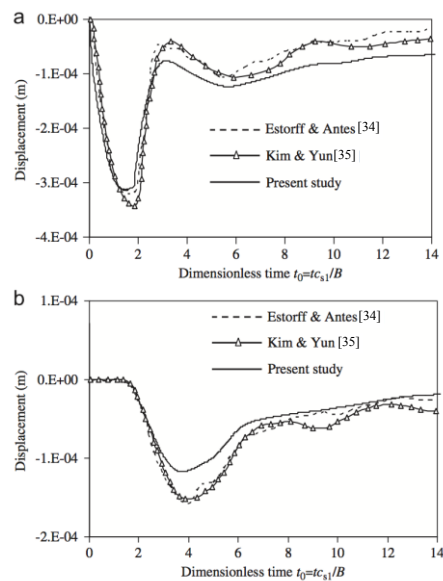

FIGURE 4. Vertical displacements in homogeneous half-space: (a) at Point A; and (b) at Point B

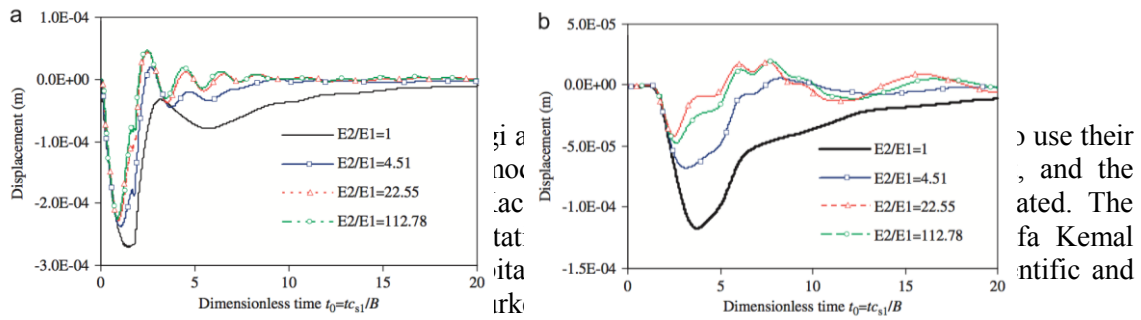

FIGURE 5. Vertical displacements for different stiffness ratios of soil layers: (a) at Point A; and (b) at Point B

## REFERENCES

- [1] J. Lysmer and R.L. Kuhlemeyer, "Finite dynamic model for infinite media," *J Eng Mech ASCE*, 95(EM4):859–77, 1969.
- [2] W. White, S. Valliappan and I.K. Lee, "Unified boundary for finite dynamic models," *J Eng Mech ASCE*, 103(5):949–64, 1977.
- [3] P. Bettess, "Infinite elements," *Int J Numer Methods Eng*, 11:53–64, 1977.
- [4] F. Medina and J. Penzien, "Infinite elements for elastodynamics," *Earthquake Eng Struct Dynamics* 10:699–709, 1982.
- [5] S. Yang, C. Yun, "Axisymmetric infinite elements for soil–structure interaction analysis," *Eng Struct* 14(6):361–70, 1992.
- [6] H.R. Yerli, B. Temel and E. Kiral, "Transient infinite elements for 2-D soil–structure-interaction analysis," *J Geotech Geoenviron Eng Div ASCE* 124(10):976–88, 1998.
- [7] J.P. Wolf and C. Song, *Finite-element modelling of unbounded media*, 1996.
- [8] J.P. Wolf, *The scaled boundary finite element method*, England: Wiley; 2003.
- [9] C. Song, F. Tin-Loi and W. Gao, "Transient dynamic analysis of interface cracks in anisotropic bimetals by the scaled boundary finite-element method," *International Journal of Solids and Structures* 47:978–89, 2010.
- [10] Z.J. Yang, Z.H. Zhang, G.H. Liu, and E.T. Ooi, "An h-hierarchical adaptive scaled boundary finite element method for elastodynamic problems," *Computers and Structures* 89(13–14):1417–29, 2011.
- [11] E.T. Ooi and Z. Yang, "Modelling dynamic crack propagation using the scaled boundary finite element method," *International Journal for Numerical Methods in Engineering* 88:329–49, 2011.
- [12] C. Song, "The scaled boundary finite element method in structural dynamics," *International Journal for Numerical Methods in Engineering*, 77: 1139–71, 2009.



- [13] S.R. Chidgzy, J. Trevelyan and A.J. Deeks, "Coupling of the boundary element method and the scaled boundary finite element method for computations in fracture mechanics," *Computers and Structures*, 86(11–12):1198–203, 2008.
- [14] Z. Yang and A.J. Deeks, "Fully-automatic modelling of cohesive crack growth using a finite element-scaled boundary finite element coupled method," *Engineering Fracture Mechanics*, 74(16):2547–73, 2007.
- [15] Z. Yang, A.J. Deeks and H. Hao, "Transient dynamic fracture analysis using scaled boundary finite element method: a frequency domain approach," *Engineering Fracture Mechanics* 74(5):669–87, 2007.
- [16] J. Qian, L.G. Tham and Y.K. Cheung, "Dynamic cross-interaction between flexible surface footings by combined BEM and FEM," *Earthquake Engineering and Structural Dynamics*, 25:509–26, 1996.
- [17] O.V. Estorff and M.J. Prabucki, "Dynamic response in the time domain by coupled boundary and finite elements," *Computational Mechanics*, 6:35–46, 1990.
- [18] A.S.M. Israil and P.K. Banerjee, "Effect of geometrical and material properties on the vertical vibration of three-dimensional foundations by BEM," *International Journal for Numerical and Analytical Methods in Geomechanics*, 14: 49–70, 1990.
- [19] G. Beer and J.O. Watson, *Introduction to Finite and Boundary Element Methods for Engineers*, New York: John Wiley & Sons; 1992.
- [20] A.A. Stamos and D.E. Beskos, "Dynamic analysis of large 3D underground structures by the BEM," *Earthquake Engineering and Structural Dynamics* 24: 917–34, 1995.
- [21] D.E. Beskos, "Boundary element methods in dynamic analysis," *Applied Mechanics Rev* 40:1–23, 1987.
- [22] D.E. Beskos, "Boundary element methods in dynamic analysis: Part II (1986–1996)," *Applied Mechanics Rev*, 50:149–97, 1997.
- [23] H. Antes and B.A. Steinfield, "Boundary formulation study of massive structures static and dynamic behavior," In: Brebbia CA, editor. *Boundary elements XIV*, vol. 2. Comp. Mech. Pub. & Elsevier Sc. Pub; 1992. p. 27–42.
- [24] F. Guan and M. Novak, "Transient response of a group of rigid strip foundations," *Earthquake Engineering and Structural Dynamics*, 23:571–685, 1994.
- [25] O.V. Estorff and M. Firuziaan, "Coupled BEM/FEM Approach for Non-Linear Soil- Structure Interaction," *Engineering Analysis with Boundary Elements*, 24:715–25, 2000.
- [26] O.V. Estorff and C. Hagen, "Iterative coupling of FEM and BEM in 3D transient elastodynamics," *Engineering Analysis with Boundary Elements*, 9: 775–87, 2005.

- [27] A.H. Tanrikulu, H.R. Yerli and A.K. Tanrikulu, “Application of the Multi-Region Boundary Element Method to Dynamic Soil-Structure Interaction Analysis,” *Computers and Geotechnics*, 28:289–307, 2001.
- [28] M.C. Genes and S. Kocak, “A combined finite element based soil-structure interaction model for large-scale systems and applications on parallel platforms,” *Engineering Structures*, 24(9):1119–31, 2002.
- [29] M.C. Genes and S. Kocak, “Parallel Treatment of Bulirsch-Stoer Interaction Scheme for Soil-Structure Interaction Problems” In: Pala S, editor. *Fifth international congress on advances in civil engineering*. Istanbul: Istanbul Technical University; 2002.
- [30] M.T.F. Cunha, J.C.F. Telles, A.L.G.A. Coutinho and J. Panetta, “On the parallelization of boundary element codes using standard and portable libraries,” *Engineering Analysis with Boundary Elements*, 28(7):893–902, 2004.
- [31] G.E. Bird, J. Trevelyan and C.E. Augarde, “A coupled BEM/scaled boundary FEM formulation for accurate computations in linear elastic fracture mechanics,” *Engineering Analysis with Boundary Elements*, 34:599–610, 2010.
- [32] K.S. Park and S.D. Heister, “On the parallelization of unsteady BEM problems with variable mesh size,” *Engineering Analysis with Boundary Elements*, 34: 289–96, 2010.
- [33] R. Bulirsch and J. Stoer, “Numerical treatment of ordinary differential equations by extrapolation methods,” *Numerische Mathematik*, 8:1–13, 1966.
- [34] O.V. Estorff and H. Antes, “Dynamic response of tunnel structures,” *Proceedings of the European Conference on Structural Dynamics*, In:Kratzig, et al., editors. Bochum; 1990.
- [35] D.K. Kim and C.B. Yun, “Time-domain soil-structure interaction analysis in two-dimensional media based on analytical frequency-dependent infinite elements,” *International Journal for Numerical Methods in Engineering* 47:1241–61, 2000.

## Design and Implementation of Resizable Cache Memory using FPGA

Safaa S. Omran<sup>1</sup>, Ibrahim A. Amory<sup>2</sup>

<sup>1&2</sup> *College of Electrical and Electronic Techniques, Baghdad, Iraq*  
*omran\_safaa@ymail.com*  
*Ibrahim\_a7@yahoo.com*

### ABSTRACT

This paper uses FPGA (Field-Programmable Gate Array) to design and implement a resizable cache memory using VHDL (Verilog Hardware Description Language). In this design the cache memory architecture allows resize its memory by cache size controller unit. The results shows the simulation of the design. This design is synthesized using (Xilinx ISE Design Suite 13.4) and simulated using (Xilinx ISim simulator).

**Keywords:** VHDL, cache size controller, resizable cache.

### 1. INTRODUCTION

Cache memory is an important part in computer system because it reduces the gap between microprocessor and Random Access Memory (RAM) speed.

Cache memory is implemented using static RAMs where the main memory uses DRAMs, the cache memory smallest, more expensive and relatively faster than DRAM [1]. The principle behind the cache memory is to prefetching the data from the main memory before the processor request for it, that occurs with phenomenon known as locality of reference and there are two principles of locality: (spatial locality) and (temporal locality) [2].

Cache size determines the number of data blocks that could be prefetching and hit ratio, the data hit occurs when microprocessor request data is existing already in cache and miss occurs when the requested data not prefetching for cache yet [3].

Cache parameter customization may be static or dynamic, in a dynamic the cache parameters can be modified within a certain range at run time, where in a static the designer sets the cache parameters before synthesis.

David H.Albonesi [4] proposed a cache design that has the ability to disable a subset of the ways in a set associative cache during the periods of modest cache activity, while the full cache way remains operational for more cache-intensive periods.

Ranganathan et al. [5] proposed a reconfigurable memory organization that allows the on-chip SRAM to be dynamically divided into different partitions that can be assigned to cache and others conventional processor activities.

Santana Gil et al. [6] proposed a design for reconfigurable cache with fixed size, the cache design can work as direct mapped cache or as 2 way set associative cache, and can select 1, 2, 4 or 8 words per block for each mode.

In this paper a resizable of cache memory is implemented using FPGA, the cache size can be selected as (4 K Blocks, 8 K Blocks, 16 K Blocks and 32 K blocks) cache size controlled by cache size controller unit.

Most researchers used a software processor in their design (like SimpleScalar toolset) when testing the cache design. In this paper, we used a hardware processor implemented on FPGA which is pipeline MIPS processor to test the cache design.

## 2. CACHE MEMORY DESIGN

Cache controller receives address that microprocessor request to access, cache controller looks for the address in tag cache, if address present in cache (cache hit) the data from that location is provided to microprocessor from data cache, else cache miss will occurs. In this paper, a Direct Mapped (D.M.) cache is designed and consist of cache size controller, cache data memory and cache controller which consist of (cache tag memory, cache tag comparator and finite state machine).

The cache memory design has the following design choices:

1. There is no Memory Management Unit (MMU) in this design because the cache memory directly receives physical addresses instead of virtual addresses.
2. Write back policy is used, all writes are made to the cache, and every cache block is assigned a bit called the *dirty bit*, at replacement time, the dirty bit is checked first, if it is set the block is written back to the main memory and then the replacement occurs.
3. Dynamic cache size of (4K blocks, 8K blocks, 16K blocks and 32K blocks) and can be modified at run time as will be shown in section 3.
4. Block size (line size) is 4 words per block and each word is 4 bytes in length.

## 3. CACHE SIZE CONTROLLER UNIT

Cache size controller unit is responsible for deciding the cache size, when the processor requested an address, this address will be send for the cache size controller unit as shown in Fig.1.

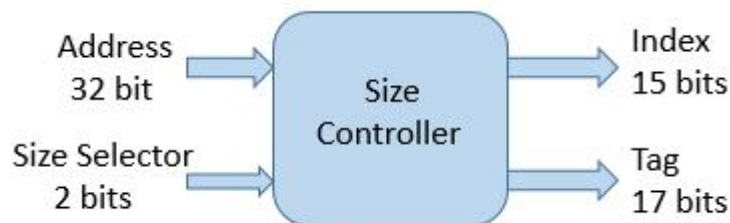

FIGURE 1. Cache size controller unit

The size is chosen by 2 bits at run time and that will consider another 4 bits called (I bits) as shown in Table 1 to ANDED with the 4<sup>th</sup> most significant index bits and

that will produces the index which will send to tag and data cache to determine which set is requested to access.

The 4<sup>th</sup> least significant bits of tag will ANDed with one's complement of (I bits) called (T bits) to produces the tag which will send to the tag cache.

TABLE 1. Truth table of cache size controller unit.

Size selector 2 bits	Cache size (in Blocks)	I bits	T bits
00	4 K	0001	1110
01	8 K	0011	1100
10	16 K	0111	1000
11	32 K	1111	0000

The processor address consists of 32 bits, in this design the maximum size of tag bits (17 bits) is store in the tag cache for each line and the index bits will be for maximum size (15 bits) as shown in Fig. 2.

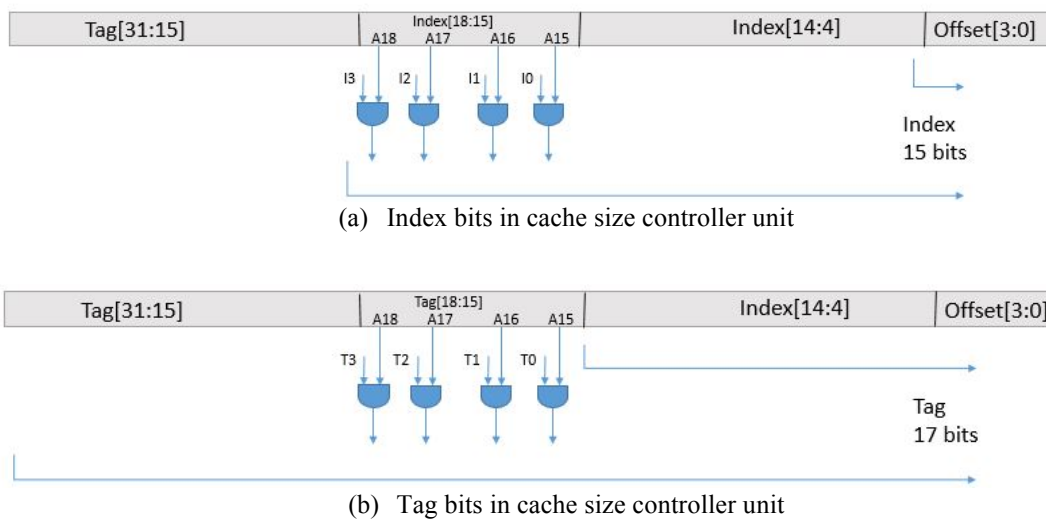

FIGURE 2. Index bits and tag bits in cache size controller unit

The cache size selected is explained as follows:

1. 4 K<sub>Blocks</sub> : Cache memory with 4 K blocks need 12 bits for index to select sets (between 0 to 4095), therefore the bits [18:15] of the 32 address bits will ANDed with (0001) so the actual 12 bits of index will be [15:4] of the 32 address bits and the most significant 3 bits of index [15:13] will equal to 0 always. For tag bits the [18:15] of the 32 address bits will ANDed with (1110) so the actual 16 bits of tag will be [31:16] of the 32 address bits.
2. 8 K<sub>Blocks</sub> : Cache memory with 8 K blocks need 13 bits for index to select sets (between 0 to 8191), therefore the bits [18:15] of the 32 address bits will ANDed with (0011) so the actual 13 bits of index will be [16:4] of the 32 address bits and the most significant 2 bits of index [15:14] will equal to 0 always. For tag bits the [18:15] of the 32 address bits will ANDed with (1100) so the actual 15 bits of tag will be [31:17] of the 32 address bits.
3. 16 K<sub>Blocks</sub> : Cache memory with 16 K blocks need 14 bits for index to select sets (between 0 to 16383), therefore the bits [18:15] of the 32 address bits will

ANDed with (0111) so the actual 14 bits of index will be [17:4] of the 32 address bits and the most significant bit of index will equal to 0 always. For tag bits the [18:15] of the 32 address bits will ANDed with (1000) so the actual 14 bits of tag will be [32:18] of the 32 address bits.

4.  $32 K_{\text{Blocks}}$  : Cache memory with 32 K blocks need 15 bits for index to select sets (between 0 to 32767), therefore the bits [18:15] of the 32 address bits will ANDed with (1111) so the actual 15 bits of index will be [18:4] of the 32 address bits. For tag bits the [18:15] of the 32 Address bits will ANDed with (0000) so the actual 13 bits of tag will be [31:19] of the 32 Address bits.

#### 4. CACHE CONTROLLER

Cache controller receives the processor requested address from cache size controller unit as index and tag and compare it with tag cache to decide whether the requested data is fetching or not, if requested data is fetching, then no main memory access is needed and data will provided to processor directly, if not the cache memory should fetches it from main memory with another several words consecutively to fill the corresponding line in cache.

Cache controller consists of:

1. Finite State Machine (FSM): the FSM controls the (read and write) signal for both cache and main memory as shown in fig. 3 and its truth table is explained in Table 2 (a) and its work explained in Table 2 (b).

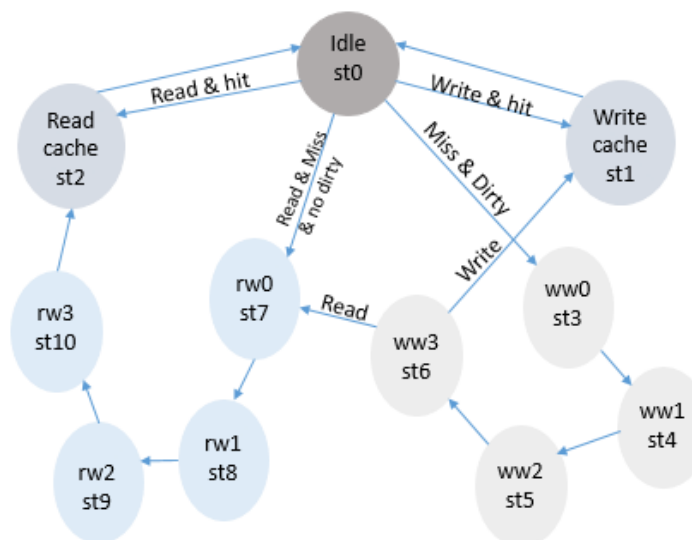

FIGURE 3. State machine for the cache controller

TABLE 2. (a)The truth table. (b) Effects of each of the ten outputs signals of cache FSM.

(a)

State	Inputs				Outputs									
	Dirty	Hit	Read	Write	Stall	Cachewr	Cacherd	Memrd	Memwr	Cache_datasrc	Mem_addrsrc	Rst_dly	Wsel	FsmDirty
Idle(st0)	X	X	0	0	0	0	0	0	0	X	X	1	00	0
WriteCache (st1)	0	X	0	1	1	1	0	0	0	0	X	1	X	0
ReadCache (st2)	X	1	1	0	1	0	1	0	0	X	X	1	X	0
WW0(st3)	1	0	1 Or 1		0	0	1	0	1	X	1	0	00	0
WW1(st4)	1	0	1 Or 1		0	0	1	0	1	X	1	0	01	0
WW2(st5)	1	0	1 Or 1		0	0	1	0	1	X	1	0	10	0
WW3(st6)	1	0	1 Or 1		0	0	1	0	1	X	1	0	11	1
RW0(st7)	0	0	1	0	0	1	0	1	0	1	0	0	00	0
RW1(st8)	0	0	1	0	0	1	0	1	0	1	0	0	01	0
RW2(st9)	0	0	1	0	0	1	0	1	0	1	0	0	10	0
RW3(st10)	0	0	1	0	0	1	0	1	0	1	0	0	11	0

(b)

Signal Name	Signal Value	Signal Effect
<b>Stall</b>	0	Main memory is accessed and the processor is stalled.
	1	Cache memory is accessed.
<b>Cachewr</b>	0	None.
	1	Data supplied by either the processor or main.
<b>Cacherd</b>	0	None.
	1	When cache hit occurs, data is supplied from cache memory to the processor.
<b>Memrd</b>	0	None.
	1	Data is supplied to the cache memory from the main memory.
<b>Memwr</b>	0	None.
	1	Data is supplied to the main memory from the cache memory.
<b>Cache_datasrc</b>	0	The data fed to the data cache memory input comes from the processor.
	1	The data fed to the data cache memory input comes from the main memory.
<b>Mem_addrsrc</b>	0	The address fed to the main memory comes from the processor.
	1	The address fed to the main memory equals to (tag & index) .
<b>Rst_dly</b>	0	There is main memory activity (read or write).
	1	There is no main memory activity.
<b>Wsel</b>	00	The first (least significant) word of memory block is selected.
	01	The second word of memory block is selected.
	10	The third word of memory block is selected.
	11	The fourth (most significant) word of memory block is selected.
<b>FsmDirty</b>	0	None.
	1	The main memory write activity was finished.

2. Tag cache: tag cache contains 17 tag bits, 1 valid bit and 1 dirty bit for each data cache line, tag bits are used for holding the 17 tag bits comes from the cache size controller of the address being accessed, the valid bit indicates whether the cache line is valid or not and dirty bit is set when the cache line is written without updating the corresponding main memory block, when the machine restarts all valid and dirty bits are reset.

## 5. COMPLETE MEMORY SYSTEM

The cache controller combined with data cache that access to the main memory consists of 4 Mbytes, arranged as 256 K line, each line has 4 words and each word is 4 bytes in length. Fig. 4 shows the connections between cache size controller, data cache, cache controller and main memory.

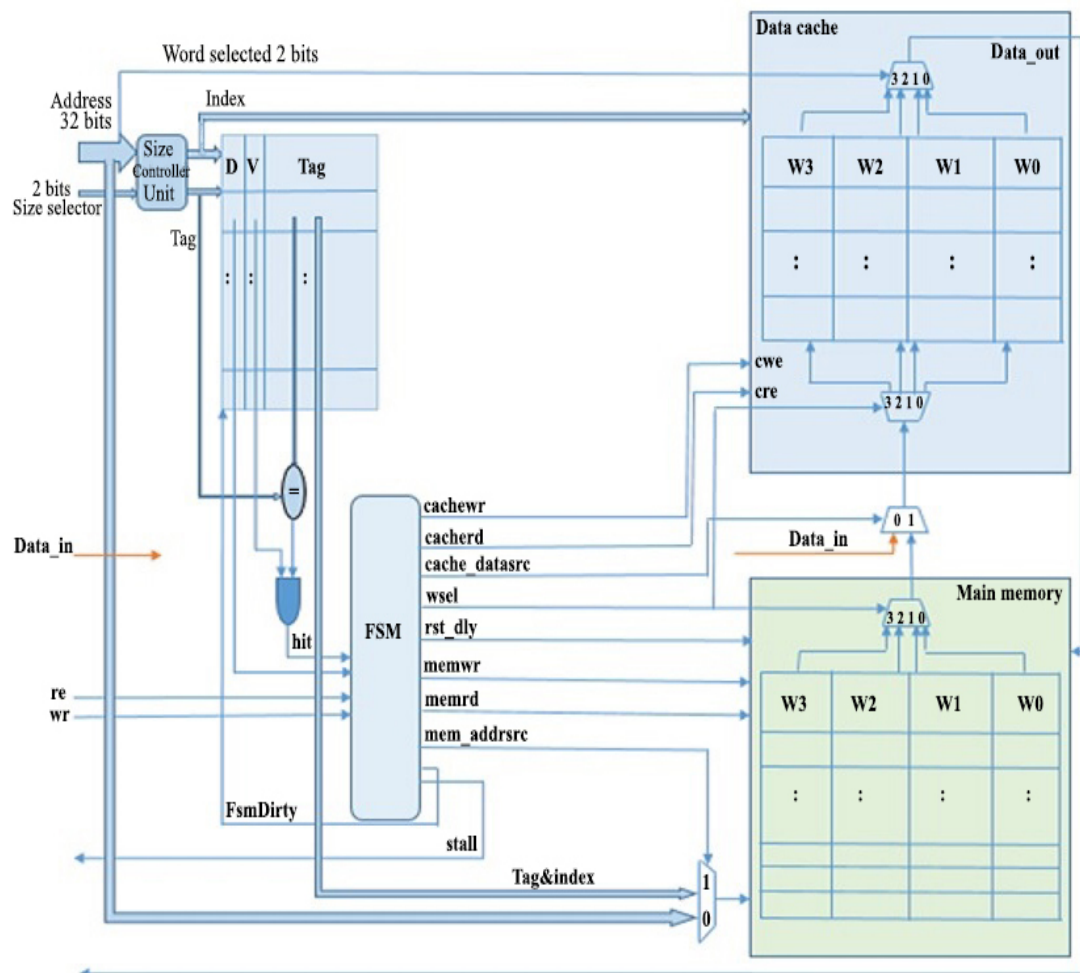

FIGURE 4. Block diagram for complete memory system



## 6. VHDL TOP\_LEVEL IMPLEMENTATION

A VHDL components of pipelined MIPS processor designed by Hadeel Sh. Mahmood [7] is combined with the VHDL components of this design, by using (*Xilinx ISE Design Suite 13.4*) all these components are connected together in order to compose the top level, later a test bench is written and used to enter the 2 bits of cache size controller and execute a test programs.

## 7. RESULTS

Fig. 5 shows the simulation of the design using (Xilinx ISim simulator) when 4 K blocks cache size is chosen by the 2 bits of cache size controller (00) and the processor requested for read a location address ( $re = 1$ ), while ( $hit = 0$ ) and ( $dirty = 1$ ) so the cache controller is stalled the processor for (8 clock cycles) until storing the previous data line which has the same index value and reads the requested address from the main memory.

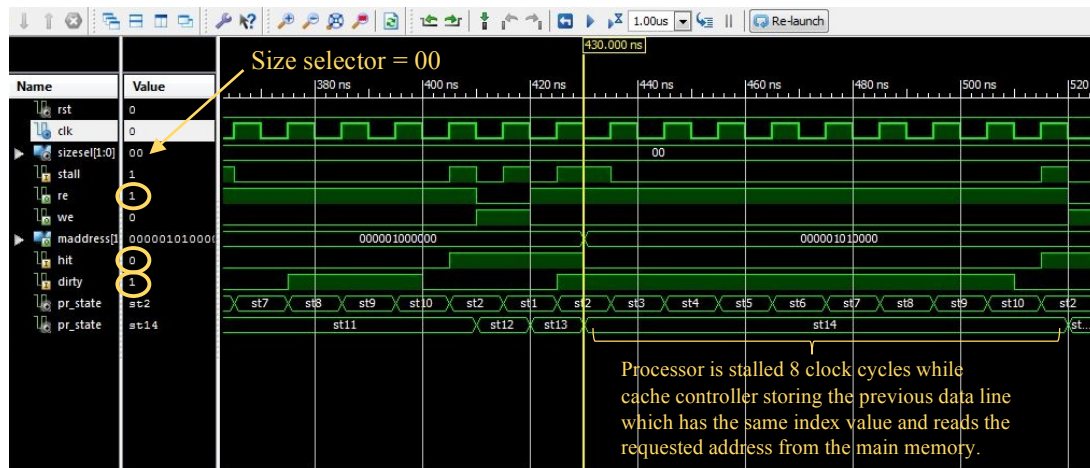

FIGURE 5. Simulation result of (4 k blocks) cache size.

Fig. 6 shows the simulation of the design when 16 K blocks cache size was chosen, the processor requested for read a location address ( $re = 1$ ), while ( $hit = 0$ ) and ( $dirty = 0$ ) so the cache controller is stalled the processor for (4 clock cycles) until reads the requested address from the main memory.

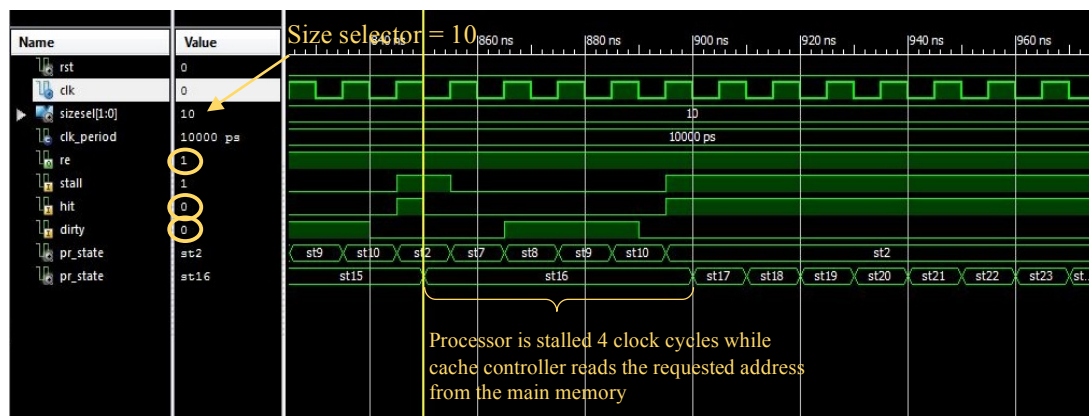

FIGURE 6. Simulation result of (16 k blocks) cache size.

Table 3 shows the hit ratio and execution time after execution the test program for each cache size chosen, this result shows that the hit ratio is depends on the cache size and for the large program the largest cache size is the best choice. The increase in hit ratio when the cache size is increased from 16K to 32K is less than the increase in hit ratio when the cache size increased from 8K to 16K. Hence, when using a cache size of 64K will result an increase in the power and cost with little benefit of hit ratio.

TABLE 3. Execution results

Cache size (blocks)	Hit ratio	Execution time (ns)
4 K	3.85%	3,880.00
8 K	16.67%	3,480.00
16 K	48.72%	2,480.00
32 K	71.8%	1,760.00

## 8. CONCLUSIONS

The VHDL design of resizable cache memory has been implemented in this paper. This cache design consists of cache size controller unit to control and choice the size of cache memory, data cache and cache controller which consists of finite state machine and tag cache, this cache design was associated with main memory and combined with a pipeline MIPS processor. The MIPS processor was used in this paper in order to enable us to run different test programs written in MIPS assembly language to test the resizable cache design.

The importance of resizable cache, that is to save power in application when the needs for a small cache size, which means to give the power only to the needed size of cache, while leaving the other blocks of cache unpowered.

## REFERENCES

- [1] Mostafa Abd-El-Barr and Hesham El-Rewini, *Fundamentals of computer organization and architecture*. New Jersey, USA: John Wiley & Sons, 2005.
- [2] Sivarama P. Dandamudi, *Fundamentals of Computer Organization and Design*. 2<sup>nd</sup> ed. New York, USA: Springer, 2002.
- [3] J. L. Hennessy and D. A. Patterson, *Computer Organization and Design: The Hardware/Software Interface*, 4<sup>th</sup> ed. Waltham, USA: Morgan Kaufmann, 2012.
- [4] Albonesi, D. H. "Selective cache ways: on demand cache resource allocation". *Journal of Instruction Level Parallelism* May. 2002.
- [5] Ranganathan, P., Adve, S. and Jouppi, N. P., "Reconfigurable caches and their application to media processing". *ACM SIGARCH Computer Architecture News*, 28(2), 214-224, 2000.
- [6] Santana Gil, A.D., Benavides, Hernandez, Herruzo, "Reconfigurable Cache implemented on an FPGA" *International Conference on Reconfigurable Computing*, 2010.
- [7] Hadeel Sh. Mahmood, "*VHDL Implementation of a Pipelined RISC Processor for Educational Purposes*". MSc. thesis, College of Electrical and Electronic Engineering Techniques, Baghdad, Iraq, 2014.